

OWNER'S MANUAL

Operation

Maintenance

Specifications

All information in this Owner's Manual is current at the time of publication. However, HYUNDAI reserves the right to make changes at any time so that our policy of continual product improvement may be carried out.

This manual applies to all models of this vehicle and includes descriptions and explanations of optional as well as standard equipment.

As a result, you may find material in this manual that does not apply to your specific vehicle.

Please note that some models are equipped with Right-Hand Drive (RHD). The explanations and illustrations for some operations in RHD models are opposite of those written in this manual.

CAUTION: MODIFICATIONS TO YOUR HYUNDAI

Your HYUNDAI should not be modified in any way. Such modifications may adversely affect the performance, safety or durability of your HYUNDAI and may, in addition, violate conditions of the limited warranties covering the vehicle. Certain modifications may also be in violation of regulations established by the Department of Transportation and other government agencies in your country.

TWO-WAY RADIO OR CELLULAR TELEPHONE INSTALLATION

Your vehicle is equipped with electronic fuel injection and other electronic components. It is possible for an improperly installed/adjusted two-way radio or cellular telephone to adversely affect electronic systems. For this reason, we recommend that you carefully follow the radio manufacturer's instructions or consult your HYUNDAI dealer for precautionary measures or special instructions if you choose to install one of these devices.

SAFETY AND VEHICLE DAMAGE WARNING

This manual includes information titled as DANGER, WARNING, CAUTION and NOTICE. These titles indicate the following:

DANGER

DANGER indicates a hazardous situation which, if not avoided, will result in death or serious injury.

WARNING

WARNING indicates a hazardous situation which, if not avoided, could result in death or serious injury.

CAUTION

CAUTION indicates a hazardous situation which, if not avoided, could result in minor or moderate injury.

NOTICE

NOTICE indicates a situation which, if not avoided, could result in vehicle damage.

FOREWORD

Thank you for choosing HYUNDAI. We are pleased to welcome you to the growing number of discriminating people who drive HYUNDAI. The advanced engineering and high-quality construction of each HYUNDAI we build is something of which we're very proud.

Your Owner's Manual will introduce you to the features and operation of your new HYUNDAI. It is suggested that you read it carefully because the information it contains can contribute greatly to the satisfaction you receive from your new car.

The manufacturer also recommends that service and maintenance on your vehicle be performed by an authorized HYUNDAI dealer.

HYUNDAI MOTOR COMPANY

Note : Because future owners will also need the information included in this manual, if you sell this HYUNDAI, please leave the manual in the vehicle for their use. Thank you.

CAUTION

Severe engine and transaxle damage may result from the use of poor quality fuels and lubricants that do not meet HYUNDAI specifications. You must always use high quality fuels and lubricants that meet the specifications listed on Page 8-6 in the Vehicle Specifications section of the Owner's Manual.

Copyright 2015 HYUNDAI Motor Company. All rights reserved. No part of this publication may be reproduced, stored in any retrieval system or transmitted in any form or by any means without the prior written permission of HYUNDAI Motor Company.

HOW TO USE THIS MANUAL

We want to help you get the greatest possible driving pleasure from your vehicle. Your Owner's Manual can assist you in many ways. We strongly recommend that you read the entire manual. In order to minimize the chance of death or injury, you must read the WARNING and CAUTION sections in the manual.

Illustrations complement the words in this manual to best explain how to enjoy your vehicle. By reading your manual, you will learn about features, important safety information, and driving tips under various road conditions.

The general layout of the manual is provided in the Table of Contents. Use the index when looking for a specific area or subject; it has an alphabetical listing of all information in your manual.

Sections: This manual has eight chapters plus an index. Each section begins with a brief list of contents so you can tell at a glance if that section has the information you want.

Your safety, and the safety of others, is very important. This Owner's Manual provides you with many safety precautions and operating procedures. This information alerts you to potential hazards that may hurt you or others, as well as damage to your vehicle.

Safety messages found on vehicle labels and in this manual describe these hazards and what to do to avoid or reduce the risks.

Warnings and instructions contained in this manual are for your safety. Failure to follow safety warnings and instructions can lead to serious injury or death.

Throughout this manual DANGER, WARNING, CAUTION, NOTICE and the SAFETY ALERT SYMBOL will be used.



This is the safety alert symbol. It is used to alert you to potential physical injury hazards. Obey all safety messages that follow this symbol to avoid possible injury or death. The safety alert symbol precedes the signal words DANGER, WARNING and CAUTION.

DANGER

DANGER indicates a hazardous situation which, if not avoided, will result in death or serious injury.

WARNING

WARNING indicates a hazardous situation which, if not avoided, could result in death or serious injury.

 **CAUTION**

CAUTION indicates a hazardous situation which, if not avoided, could result in minor or moderate injury.

NOTICE

NOTICE indicates a situation which, if not avoided, could result in vehicle damage.

FUEL REQUIREMENTS

Gasoline engine

Unleaded

For Europe

For the optimal vehicle performance, we recommend you use unleaded gasoline which has an octane rating of RON (Research Octane Number) 95 / AKI (Anti Knock Index) 91 or higher. You may use unleaded gasoline with an octane rating of RON 91-94 / AKI 87-90 but it may result in slight performance reduction of the vehicle. (Do not use methanol blended fuels)

Except Europe

Your new vehicle is designed to use only unleaded fuel having an Octane Rating of RON (Research Octane Number) 91 / AKI (Anti-Knock Index) 87 or higher. (Do not use methanol blended fuels)

Your new vehicle is designed to obtain maximum performance with UNLEADED FUEL, as well as minimize exhaust emissions and spark plug fouling.

 **CAUTION**

NEVER USE LEADED FUEL. The use of leaded fuel is detrimental to the catalytic converter and will damage the engine control system's oxygen sensor and affect emission control.

Never add any fuel system cleaning agents to the fuel tank other than what has been specified (We recommend that you consult an authorized HYUNDAI dealer for details.)

 **WARNING**

- **Do not "top off" after the nozzle automatically shuts off when refueling.**
- **Always check that the fuel cap is installed securely to prevent fuel spillage in the event of an accident.**

Leaded (if equipped)

For some countries, your vehicle is designed to use leaded gasoline. When you are going to use leaded gasoline, we recommend that you ask an authorized HYUNDAI dealer.

Octane rating of leaded gasoline is same with unleaded one.

Gasoline containing alcohol and methanol

Gasohol, a mixture of gasoline and ethanol (also known as grain alcohol), and gasoline or gasohol containing methanol (also known as wood alcohol) are being marketed along with or instead of leaded or unleaded gasoline.

Do not use gasohol containing more than 10% ethanol, and do not use gasoline or gasohol containing any methanol. Either of these fuels may cause drivability problems and damage to the fuel system, engine control system and emission control system.

Discontinue using gasohol of any kind if drivability problems occur.

Vehicle damage or driveability problems may not be covered by the manufacturer's warranty if they result from the use of:

1. Gasohol containing more than 10% ethanol.
2. Gasoline or gasohol containing methanol.
3. Leaded fuel or leaded gasohol.

**CAUTION**

Never use gasohol which contains methanol. Discontinue use of any gasohol product which impairs drivability.

Other fuels

Using fuel additives such as:

- Silicone fuel additive
- MMT (Magnanese, Mn) fuel additive
- Ferrocene (iron-based) fuel additive
- Other metallic-based fuel additives

may result in cylinder misfire, poor acceleration, engine stalling, damage to the catalyst, or abnormal corrosion, and may cause damage to the engine resulting in a reduction in the overall life of the powertrain.

NOTICE

Damage to the fuel system or performance problem caused by the use of these fuels may not be covered by your New Vehicle Limited Warranty.

Use of MTBE

HYUNDAI recommends avoiding fuels containing MTBE (Methyl Tertiary Butyl Ether) over 15.0% vol. (Oxygen Content 2.7% weight) in your vehicle.

Fuel containing MTBE over 15.0% vol. (Oxygen Content 2.7% weight) may reduce vehicle performance and produce vapor lock or hard starting.

CAUTION

Your New Vehicle Limited Warranty may not cover damage to the fuel system and any performance problems that are caused by the use of fuels containing methanol or fuels containing MTBE (Methyl Tertiary Butyl Ether) over 15.0% vol. (Oxygen Content 2.7% weight.)

Do not use methanol

Fuels containing methanol (wood alcohol) should not be used in your vehicle. This type of fuel can reduce vehicle performance and damage components of the fuel system, engine control system and emission control system.

Fuel Additives

HYUNDAI recommends that you use unleaded gasoline which has an octane rating of RON (Research Octane Number) 95 / AKI (Anti Knock Index) 91 or higher (for Europe) or Octane Rating of RON (Research Octane Number) 91 / AKI (Anti-Knock Index) 87 or higher (except Europe).

For customers who do not use good quality gasolines including fuel additives regularly, and have problems starting or the engine does not run smoothly, one bottle of additives added to the fuel tank at every 15,000km (for Europe)/ 5,000km (except Europe). Additives are available from your authorized HYUNDAI dealer along with information on how to use them. Do not mix other additives.

Operation in foreign countries

If you are going to drive your vehicle in another country, be sure to:

- Observe all regulations regarding registration and insurance.
- Determine that acceptable fuel is available.

Diesel engine

Diesel fuel

Diesel engine must be operated only on commercially available diesel fuel that complies with EN 590 or comparable standard. (EN stands for "European Norm"). Do not use marine diesel fuel, heating oils, or non-approved fuel additives, as this will increase wear and cause damage to the engine and fuel system. The use of non-approved fuels and / or fuel additives will result in a limitation of your warranty rights.

Diesel fuel of above cetane 51 is used in your vehicle. If two types of diesel fuel are available, use summer or winter fuel properly according to the following temperature conditions.

- Above -5°C (23°F) ... Summer type diesel fuel.
- Below -5°C (23°F) ... Winter type diesel fuel.

Watch the fuel level in the tank very carefully : If the engine stops through fuel failure, the circuits must be completely purged to permit restarting.

CAUTION

Do not let any gasoline or water enter the tank. This would make it necessary to drain it out and to bleed the lines to avoid jamming the injection pump and damaging the engine.

CAUTION

Diesel Fuel (if equipped with DPF)

It is recommended to use the regulated automotive diesel fuel for diesel vehicle equipped with the DPF system.

If you use diesel fuel including high sulfur (more than 50 ppm sulfur) and unspecified additives, it can cause the DPF system to be damaged and white smoke can be emitted.

Biodiesel

Commercially supplied Diesel blends of no more than 7% biodiesel, commonly known as "B7 Diesel" may be used in your vehicle if Biodiesel meets EN 14214 or equivalent specifications. (EN stands for "European Norm"). The use of biofuels exceeding 7% made from rapeseed methyl ester (RME), fatty acid methyl ester (FAME), vegetable oil methyl ester (VME) etc. or mixing diesel exceeding 7% with biodiesel will cause increased wear or damage to the engine and fuel system. Repair or replacement of worn or damaged components due to the use of non approved fuels will not be covered by the manufactures warranty.

CAUTION

- **Never use any fuel, whether diesel, B7 biodiesel or otherwise, that fails to meet the latest petroleum industry specification.**
- **Never use any fuel additives or treatments that are not recommended or approved by the vehicle manufacturer.**

VEHICLE BREAK-IN PROCESS

By following a few simple precautions for the first 1,000 km (600 miles) you may add to the performance, economy and life of your vehicle.

- Do not race the engine.
- While driving, keep your engine speed (rpm, or revolutions per minute) between 2,000 rpm and 4,000 rpm.
- Do not maintain a single speed for long periods of time, either fast or slow. Varying engine speed is needed to properly break-in the engine.
- Avoid hard stops, except in emergencies, to allow the brakes to seat properly.
- Don't tow a trailer during the first 2,000 km (1,200 miles) of operation.

RETURNING USED VEHICLES (FOR EUROPE)

HYUNDAI promotes an environmentally sound treatment for end of life vehicles and offers to take back your HYUNDAI end of life vehicles in accordance with the European Union (EU) End of Life Vehicles Directive.

You can get detailed information from your national HYUNDAI homepage.

TABLE OF CONTENTS

Your vehicle at a glance	1
Safety system of your vehicle	2
Convenient features of your vehicle	3
Multimedia System	4
Driving your vehicle	5
What to do in an emergency	6
Maintenance	7
Specifications & Consumer information	8
Index	I

1 Your vehicle at a glance

Exterior overview (I)	1-2
Exterior overview (II)	1-3
Interior overview	1-4
Instrument panel overview	1-6
Engine compartment	1-8

2 Safety system of your vehicle

Important safety precautions	2-2
Always wear your seat belt	2-2
Restrain all children	2-2
Air bag hazards	2-2
Driver distraction	2-2
Control your speed	2-3
Keep your vehicle in safe condition	2-3
Seats	2-4
Safety precautions	2-5
Front seats.....	2-6
Rear seats.....	2-12
Headrest	2-16
Seat warmers and air ventilation seats.....	2-20
Seat belts	2-24
Seat belt safety precautions	2-24
Seat belt warning light	2-25
Seat belt restraint system	2-26
Additional seat belt safety precautions	2-31
Care of seat belts	2-33
Child restraint system (CRS)	2-34
Children always in the rear	2-34
Selecting a Child Restraint System (CRS)	2-35
Installing a Child Restraint System (CRS).....	2-37

Air bag	
– supplemental restraint system	2-2-46
Where are the air bags?	2-49
How does the air bags system operate?	2-52
What to expect after an air bag inflates	2-56
Do not install a child restraint on the front passenger seat.....	2-57
Why didn't my air bag go off in a collision?	2-58
SRS care	2-63
Additional safety precautions	2-64
Air bag warning labels.....	2-65

3 Convenient features of your vehicle

Accessing your vehicle	3-4
Remote key.....	3-4
Smart key.....	3-8
Immobilizer system	3-13
Door locks	3-14
Operating door locks from outside the vehicle	3-14
Operating door locks from inside the vehicle	3-16
Auto door lock/unlock features.....	3-18
Child-protector rear door locks.....	3-19
Theft-alarm system.....	3-20
Driver position memory system.....	3-21
Storing memory positions.....	3-21
Easy access function	3-22
Steering wheel.....	3-23
Electric power steering (EPS).....	3-23
Tilt steering / Telescope steering.....	3-24
Heated steering wheel.....	3-25
Horn.....	3-25
Mirrors.....	3-26
Inside rearview mirror.....	3-26
Outside rearview mirror	3-27

Windows	3-31	Trip computer	3-90
Power windows.....	3-31	Conventional cluster	3-90
Sunroof	3-37	Supervision cluster	3-94
Sunroof opening and closing.....	3-37	Light	3-99
Sliding the sunroof	3-37	Exterior lights	3-99
Tilting the sunroof	3-38	Welcome system	3-106
Sunshade.....	3-39	Interior lights.....	3-107
Resetting the sunroof	3-40	Wipers and washers	3-110
Exterior features	3-41	Windshield wipers	3-110
Hood	3-41	Windshield washers.....	3-112
Trunk	3-43	Driver assist system	3-114
Smart trunk.....	3-44	Rear view camera.....	3-114
Fuel filler door.....	3-48	Rear parking assist system	3-115
Instrument cluster	3-51	Parking assist system	3-118
Instrument cluster control	3-53	Defroster	3-122
Gauges	3-54	Rear window defroster	3-122
Odometer.....	3-57	Manual climate control system	3-123
Warning and indicator lights.....	3-57	Heating and air conditioning.....	3-124
LCD display messages.....	3-71	System operation.....	3-129
LCD display (for supervision cluster)	3-82	System maintenance	3-132
LCD display control.....	3-82	Automatic climate control system	3-134
LCD modes	3-82	Automatic heating and air conditioning.....	3-135
User settings mode.....	3-86	Manual heating and air conditioning.....	3-136
		System operation	3-143
		System maintenance	3-146

Windshield defrosting and defogging	3-148
Manual climate control system	3-148
Automatic climate control system	3-149
Defogging logic.....	3-150
Auto defogging system	3-151
Climate control additional features.....	3-152
Cluster ionizer.....	3-152
Sunroof inside air recirculation.....	3-152
Storage compartment.....	3-153
Center console storage	3-153
Sliding armrest.....	3-153
Glove box	3-154
Sunglass holder	3-154
Multi box	3-155
Interior features.....	3-156
Ashtray	3-156
Cup holder.....	3-156
Sunvisor.....	3-157
Power outlet.....	3-158
USB charger	3-159
Cigarette lighter	3-159
Clock.....	3-160
Clothes hanger	3-160
Floor mat anchor(s).....	3-161
Luggage net (holder)	3-161

4

Multimedia system

Multimedia system	4-2
Aux, USB and iPod® port	4-2
Antenna	4-3
Steering wheel audio control	4-4
Audio / Video / Navigation system (AVN)	4-5
<i>Bluetooth®</i> Wireless Technology hands-free	4-5
How vehicle radio works	4-6
Audio (Without Touch Screen)	4-9
Feature of Your Audio.....	4-10
Radio Mode (Type A-1, Type A-2, Type A-3, Type A-4 with RDS).....	4-28
Radio Mode (Type A-5, Type A-6).....	4-30
Media Mode.....	4-31
Phone Mode	4-38
Setup Mode (Type A-1, Type A-2, Type A-3, Type A-4).....	4-40
Setup Mode (Type A-5, Type A-6).....	4-46

Audio (With Touch Screen)	4-54
Feature of Your Audio	4-55
Radio Mode	
(Type B-1, Type B-2, Type B-3, Type B-4)	4-72
Radio Mode (Type B-5, Type B-6)	4-74
Media Mode	4-75
Phone Mode	4-90
<i>Bluetooth®</i> Wireless Technology	
(Type B-1, Type B-2, Type B-3, Type B-4)	4-90
<i>Bluetooth®</i> Wireless Technology	
(Type B-5, Type B-6)	4-97
Setup Mode	
(Type B-1, Type B-2, Type B-3, Type B-4)	4-103
Setup Mode (Type B-5, Type B-6)	4-110
Declaration of Conformity	4-117
FCC	4-117
CE for EU	4-119
PCC for Taiwan	4-121
ACMA for Australia	4-122
ANATEL for Brazil	4-124
SMA for Jamaica	4-127
IFETEL for Mexico	4-128
MOC for Israel	4-129

5 Driving your vehicle

Before driving	5-4
Before entering the vehicle	5-4
Before starting	5-4
Ignition switch	5-5
Key ignition switch	5-6
Engine Start/Stop button	5-11
Manual transmission	5-20
Manual transmission operation	5-20
Good driving practices	5-22
Automatic transmission	5-24
Automatic transmission operation	5-24
Parking	5-29
Good driving practices	5-29
Dual clutch transmission	5-31
Dual clutch transmission operation	5-31
Parking	5-39
Good driving practices	5-39

Braking system	5-41
Power brakes	5-41
Disc brakes wear indicator	5-42
Rear drum brakes	5-42
Parking brake	5-42
Anti-lock Brake System (ABS)	5-45
Electronic Stability Control (ESC).....	5-47
Vehicle Stability Management (VSM).....	5-50
Hill-start Assist Control (HAC).....	5-52
Emergency Stop Signal (ESS)	5-52
Good braking practices.....	5-53
ISG (Idle Stop and Go) system	5-54
To activate the ISG system	5-54
To deactivate the ISG system	5-57
ISG system malfunction.....	5-57
The battery sensor deactivation	5-59
Drive mode integrated control system	5-60
Blind Spot Detection system (BSD)	5-62
BSD (Blind Spot Detection) /	
LCA (Lane Change Assist).....	5-63
RCTA (Rear Cross Traffic Alert)	5-66
Limitations of the system	5-69
Cruise control	5-71
Cruise Control operation	5-71
Special driving conditions	5-78
Hazardous driving conditions.....	5-78
Rocking the vehicle	5-78
Smooth cornering	5-79
Driving at night	5-79
Driving in the rain	5-79
Driving in flooded areas.....	5-80
Highway driving	5-80
Winter driving	5-81
Snow or icy conditions	5-81
Winter Precautions	5-83
Trailer towing	5-86
If you decide to pull a trailer	5-87
Trailer towing equipment	5-91
Driving with a trailer	5-92
Maintenance when towing a trailer	5-96
Vehicle weight	5-97
Overloading.....	5-97

6 What to do in an emergency

Hazard warning flasher	6-2
In case of an emergency while driving	6-2
If the engine stalls while driving	6-2
If the engine stalls at a crossroad or crossing	6-3
If you have a flat tire while driving	6-3
If the engine will not start	6-4
If the engine doesn't turn over or turns over slowly	6-4
If the engine turns over normally but doesn't start	6-4
Jump starting	6-4
If the engine overheats	6-8
Tire Pressure Monitoring System (TPMS).....	6-10
Check tire pressure	6-10
Tire Pressure Monitoring System.....	6-11
Low tire pressure telltale	6-12
Low tire pressure position and Tire pressure telltale	6-12
TPMS (Tire Pressure Monitoring System) malfunction indicator	6-13
Changing a tire with TPMS.....	6-14

If you have a flat tire.....	6-16
Jack and tools	6-16
Changing tires	6-17
Jack label.....	6-22
EC Declaration of conformity for Jack.....	6-23
Towing	6-24
Towing service	6-24
Removable towing hook	6-25
Emergency towing	6-26
Emergency commodity	6-28
Fire extinguisher	6-28
First aid kit	6-28
Triangle reflector	6-28
Tire pressure gauge	6-28

7 Maintenance

Engine compartment	7-3
Maintenance services	7-6
Owner's responsibility	7-6
Owner maintenance precautions	7-6
Owner maintenance	7-7
Owner maintenance schedule	7-8
Scheduled maintenance services	7-10
Normal maintenance schedule	
- Gasoline engine (For Europe)	7-11
Maintenance under severe usage and low mileage conditions - Gasoline engine (For Europe)	7-14
Normal maintenance schedule	
- Gasoline engine (Except Europe)	7-16
Maintenance under severe usage and low mileage conditions - Gasoline engine (Except Europe)	7-20
Normal maintenance schedule - Diesel engine	7-22
Maintenance under severe usage and low mileage conditions - Diesel engine	7-26
Explanation of scheduled maintenance items ..	7-28
Engine oil	7-32
Checking the engine oil level	7-32
Checking the engine oil and filter	7-34
Engine coolant	7-35
Checking the engine coolant level	7-35
Changing the coolant	7-37
Brake/clutch fluid	7-38
Checking the brake/clutch fluid level	7-38
Washer fluid	7-40
Checking the washer fluid level	7-40
Parking brake	7-41
Checking the parking brake	7-41
Fuel filter (for Diesel)	7-41
Draining water from fuel filter	7-41
Air cleaner	7-42
Filter replacement	7-42
Climate control air filter	7-44
Filter inspection	7-44
Filter replacement	7-44
Wiper blades	7-45
Blade inspection	7-45
Blade replacement	7-45
Battery	7-48
For best battery service	7-48
Battery capacity label	7-50
Battery recharging	7-50
Reset items	7-51

Tires and wheels	7-52
Tire care	7-52
Recommended cold tire inflation pressures.....	7-52
Checking tire inflation pressure.....	7-54
Tire rotation	7-55
Wheel alignment and tire balance	7-56
Tire replacement	7-56
Wheel replacement.....	7-58
Tire traction.....	7-58
Tire maintenance	7-58
Tire sidewall labeling.....	7-58
Low aspect ratio tire	7-63
Fuses	7-64
Fuse/Relay panel description	7-70
Light bulbs	7-84
Headlamp, position lamp, turn signal lamp and fog lamp light bulb replacement	7-85
Side repeater lamp replacement	7-91
Headlamp and front fog lamp aiming (for Europe)...	7-92
Rear combination lamp bulb replacement	7-97
High mounted stop lamp replacement.....	7-101
License plate light bulb replacement	7-101
Interior light bulb replacement.....	7-102

Appearance care	7-103
Exterior care	7-103
Interior care	7-109
Emission control system	7-111
Crankcase emission control system.....	7-111
Evaporative emission control system	7-111
Exhaust emission control system.....	7-112

8 Specifications & Consumer information

Dimensions	8-2
Engine	8-2
Bulb wattage	8-3
Tires and wheels	8-4
Air conditioning system	8-4
Tire load and speed capacity	8-5
Volume and weight	8-5
Recommended lubricants and capacities	8-6
Recommended SAE viscosity number	8-8
Vehicle identification number (VIN)	8-9
Vehicle certification label	8-9
Tire specification and pressure label	8-10
Engine number	8-10
Air conditioner compressor label	8-11
Declaration of conformity	8-11

Your vehicle at a glance

Exterior overview (I)	1-2
Exterior overview (II)	1-3
Interior overview.....	1-4
Instrument panel overview	1-6
Engine compartment	1-8

EXTERIOR OVERVIEW (I)

■ Front view

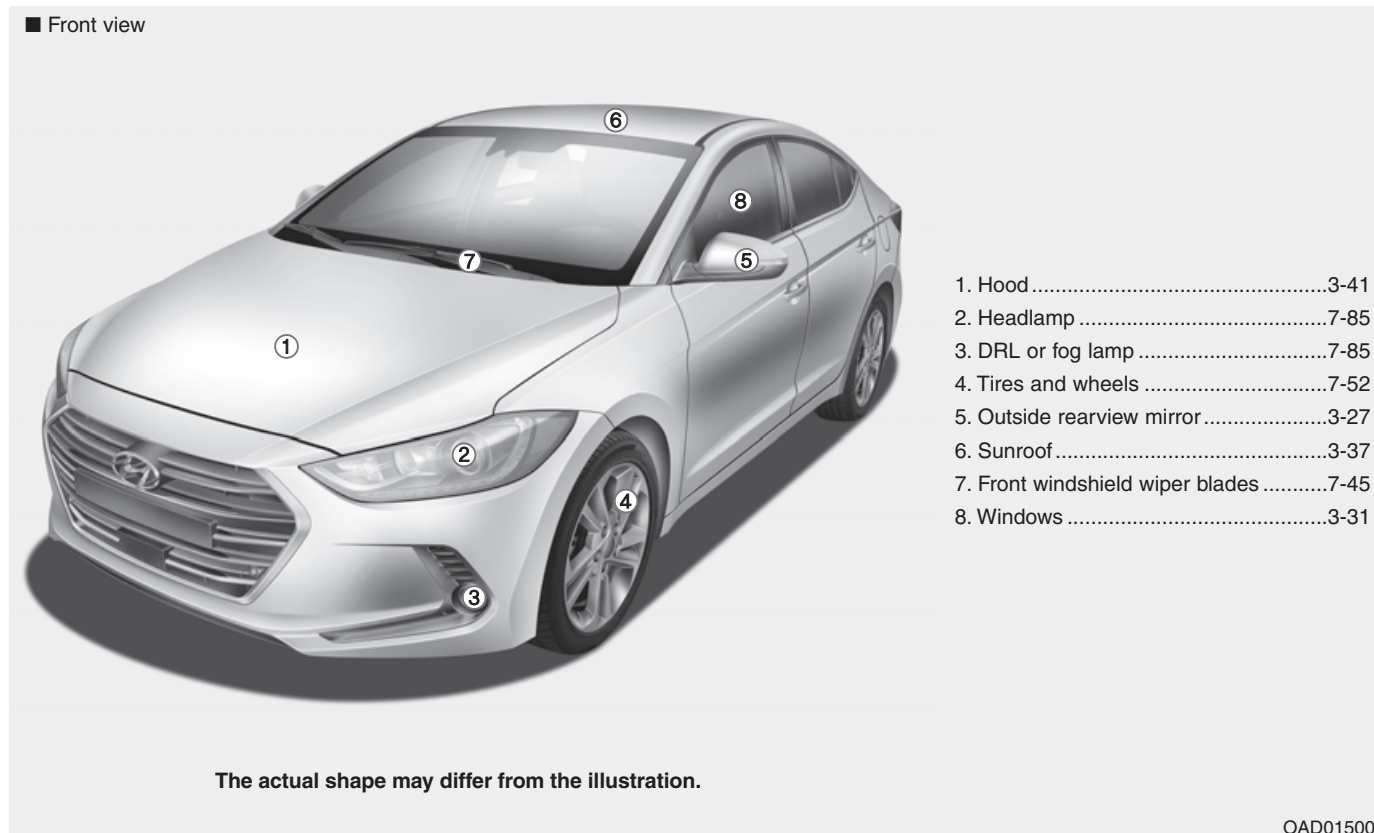

OAD015001

EXTERIOR OVERVIEW (II)

■ Rear view



- 1. Antenna4-3
- 2. Doors3-14
- 3. Fuel filler door.....3-48
- 4. Rear parking assist system3-115
- 5. Rear combination lamp7-97
- 6. High mounted stop lamp7-101
- 7. Rearview camera3-114
- 8. Trunk.....3-43

The actual shape may differ from the illustration.

OAD015002

INTERIOR OVERVIEW (I)

■ Left-hand drive

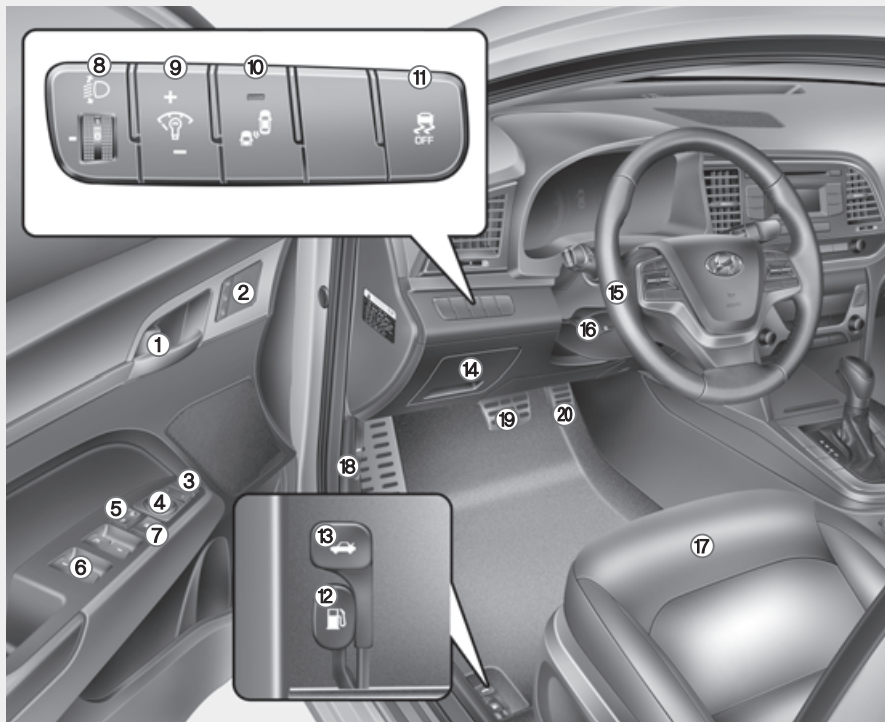

1. Door lock/unlock button3-16
2. Driver position memory system3-21
3. Outside rearview mirror folding switch3-29
4. Outside rearview mirror control switch3-28
5. Central door lock switch3-17
6. Power window switches3-31
7. Power window lock switch3-35
8. Headlight leveling device3-105
9. Instrument panel illumination control switch3-53
10. Blind spot detection system button ..5-63
11. ESC OFF button5-47
12. Fuel filler door opener3-48
13. Trunk release lever3-43
14. Fuse box7-66
15. Steering wheel3-23
16. Steering wheel tilt/telescope lever.....3-24
17. Seat2-4
18. Hood release lever3-41
19. Brake pedal5-41
20. Accelerator pedal

The actual shape may differ from the illustration.

OAD015003L

INTERIOR OVERVIEW (II)

■ Right-hand drive

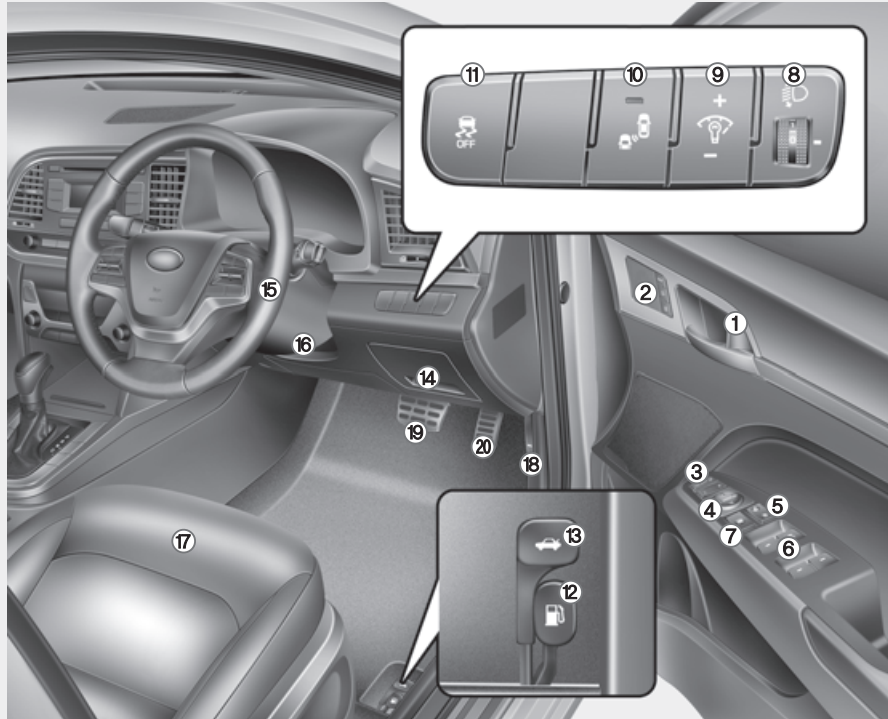

The actual shape may differ from the illustration.

1. Door lock/unlock button3-16
2. Driver position memory system3-21
3. Outside rearview mirror folding switch3-29
4. Outside rearview mirror control switch3-28
5. Central door lock switch3-17
6. Power window switches3-31
7. Power window lock switch3-35
8. Headlight leveling device3-105
9. Instrument panel illumination control switch3-53
10. Blind spot detection system button ..5-63
11. ESC OFF button5-47
12. Fuel filler door opener3-48
13. Trunk release lever3-43
14. Fuse box7-66
15. Steering wheel3-23
16. Steering wheel tilt/telescope lever.....3-24
17. Seat2-4
18. Hood release lever3-41
19. Brake pedal5-41
20. Accelerator pedal

OAD015003RE

INSTRUMENT PANEL OVERVIEW (I)

■ Left-hand drive

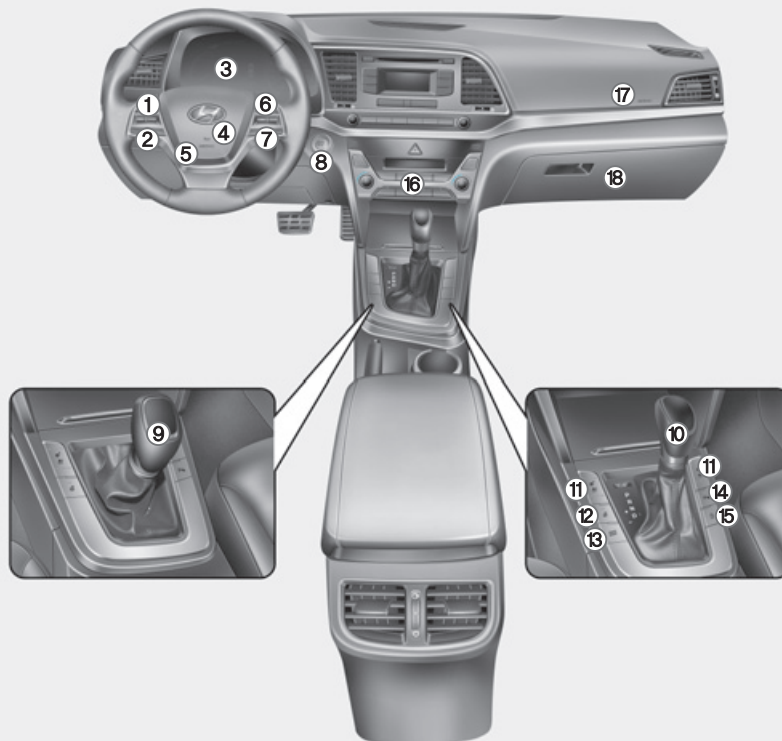

The actual shape may differ from the illustration.

1. Light control / Turn signals3-99
2. Steering wheel audio controls / Bluetooth® wireless technology hands-free controls4-4, 5
3. Instrument cluster3-51
4. Horn3-25
5. Driver's front air bag2-49
6. Wiper/Washer3-110
7. Cruise controls5-71
8. Key ignition switch / Engine Start/Stop button5-6, 11
9. Manual transmission5-20
10. Automatic transmission / Dual clutch transmission5-24, 31
11. Seat warmer / Air ventilation seat2-20
12. Heated steering wheel3-25
13. Drive mode integrated control system ...5-60
14. Parking assist system3-118
15. Idle stop and go (ISG)5-54
16. Manual climate control / Automatic climate control system ..3-123, 134
17. Passenger's front air bag2-49
18. Glove box3-154

OAD015005L

INSTRUMENT PANEL OVERVIEW (II)

■ Right-hand drive

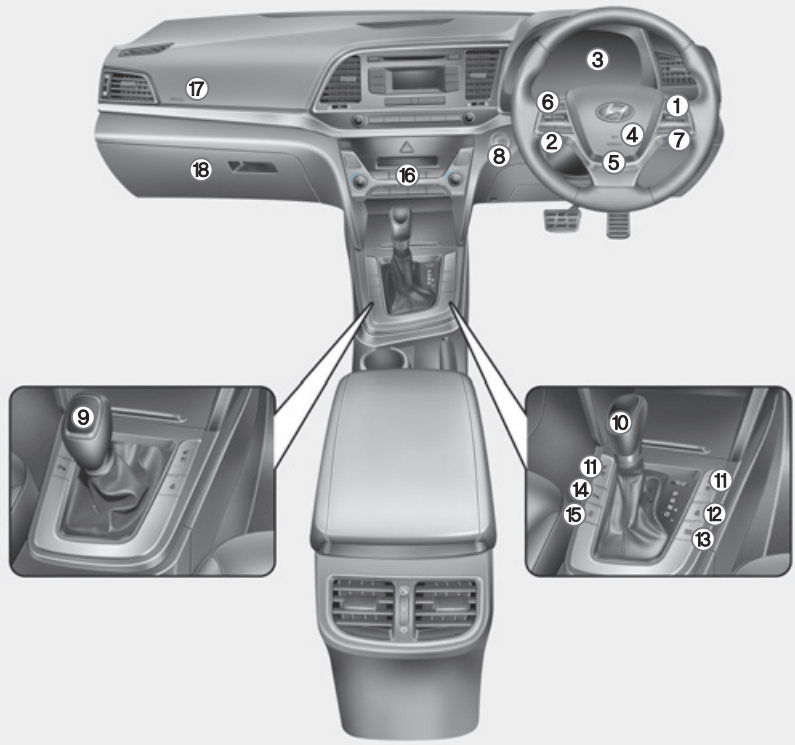

- 1. Light control / Turn signals3-99
- 2. Steering wheel audio controls /
Bluetooth[®] wireless technology
hands-free controls4-4, 5
- 3. Instrument cluster3-51
- 4. Horn3-25
- 5. Driver's front air bag2-49
- 6. Wiper/Washer3-110
- 7. Cruise controls5-71
- 8. Key ignition switch /
Engine Start/Stop button5-6, 11
- 9. Manual transmission5-20
- 10. Automatic transmission /
Dual clutch transmission5-24, 31
- 11. Seat warmer / Air ventilation seat2-20
- 12. Heated steering wheel3-25
- 13. Drive mode integrated control system ..5-60
- 14. Parking assist system3-118
- 15. Idle stop and go (ISG)5-54
- 16. Manual climate control /
Automatic climate control system ..3-123, 134
- 17. Passenger's front air bag2-49
- 18. Glove box3-154

The actual shape may differ from the illustration.

OAD015005RE

ENGINE COMPARTMENT

■ Gasoline Engine (Nu 2.0 MPI)

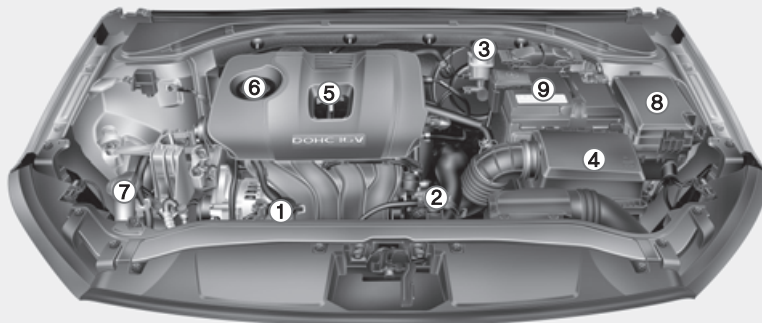

■ Gasoline Engine (Gamma 1.6 MPI)

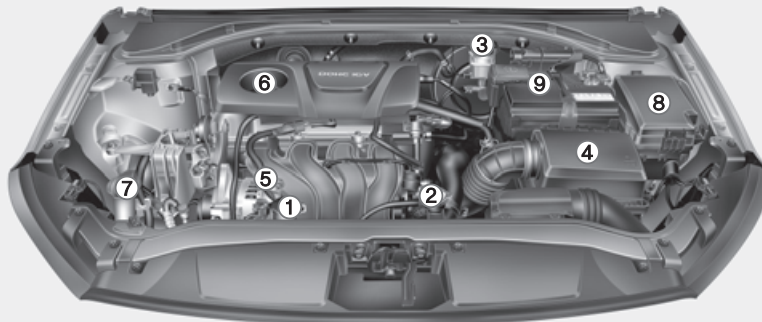

The actual engine room in the vehicle may differ from the illustration.

- 1. Engine coolant reservoir.....7-36
- 2. Radiator cap7-35
- 3. Brake/clutch fluid reservoir7-38
- 4. Air cleaner7-42
- 5. Engine oil dipstick.....7-32
- 6. Engine oil filler cap.....7-33
- 7. Windshield washer fluid reservoir.....7-40
- 8. Fuse box.....7-66
- 9. Battery7-48

OAD075100L/OAD075101L

■ Diesel Engine (UII 1.6 TCI)

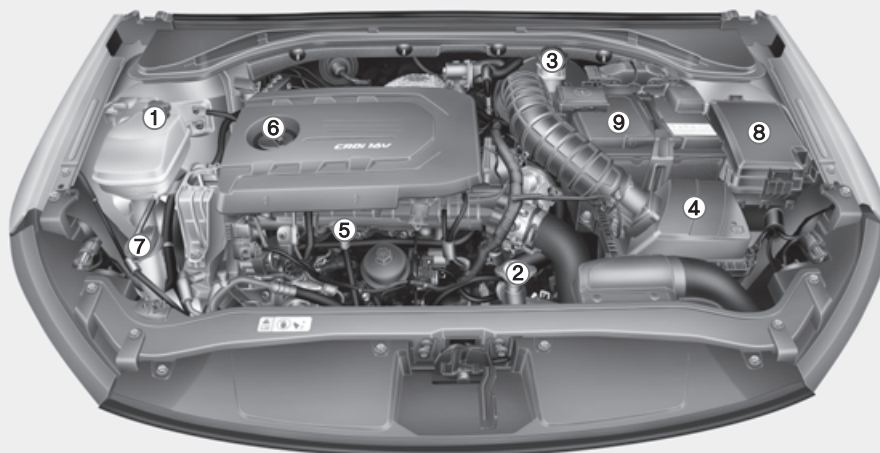

1. Engine coolant reservoir.....7-36
2. Radiator cap7-35
3. Brake/clutch fluid reservoir7-38
4. Air cleaner7-42
5. Engine oil dipstick.....7-32
6. Engine oil filler cap7-33
7. Windshield washer fluid reservoir.....7-40
8. Fuse box.....7-66
9. Battery7-48

The actual engine room in the vehicle may differ from the illustration.

OAD075001

Safety system of your vehicle

This chapter provides you with important information about how to protect yourself and your passengers. It explains how to properly use your seats and seat belts, and how your air bags work. Additionally, this chapter explains how to properly restrain infants and children in your vehicle.

Important safety precautions	2-2	Child restraint system (CRS)	2-34
Always wear your seat belt	2-2	Children always in the rear	2-34
Restrain all children	2-2	Selecting a Child Restraint System (CRS)	2-35
Air bag hazards	2-2	Installing a Child Restraint System (CRS).....	2-37
Driver distraction	2-2	Air bag	
Control your speed	2-3	- supplemental restraint system.....	2-46
Keep your vehicle in safe condition	2-3	Where are the air bags?	2-49
Seats	2-4	How does the air bags system operate?	2-52
Safety precautions	2-5	What to expect after an air bag inflates	2-56
Front seats.....	2-6	Do not install a child restraint on the front	
Rear seats.....	2-12	passenger seat.....	2-57
Headrest	2-16	Why didn't my air bag go off in a collision?	2-58
Seat warmers and air ventilation seats.....	2-20	SRS care	2-63
Seat belts	2-24	Additional safety precautions	2-64
Seat belt safety precautions	2-24	Air bag warning labels.....	2-65
Seat belt warning light	2-25		
Seat belt restraint system	2-26		
Additional seat belt safety precautions	2-31		
Care of seat belts	2-33		

IMPORTANT SAFETY PRECAUTIONS

You will find many safety precautions and recommendations throughout this section, and throughout this manual. The safety precautions in this section are among the most important.

Always wear your seat belt

A seat belt is your best protection in all types of accidents. Air bags are designed to supplement seat belts, not replace them. So even though your vehicle is equipped with air bags, ALWAYS make sure you and your passengers wear your seat belts, and wear them properly.

Restrain all children

All children under age 13 should ride in your vehicle properly restrained in a rear seat, not the front seat. Infants and small children should be restrained in an appropriate child restraint. Larger children should use a booster seat with the lap/shoulder belt until they can use the seat belt properly without a booster seat.

Air bag hazards

While air bags can save lives, they can also cause serious or fatal injuries to occupants who sit too close to them, or who are not properly restrained. Infants, young children, and short adults are at the greatest risk of being injured by an inflating air bag. Follow all instructions and warnings in this manual.

Driver distraction

Driver distraction presents a serious and potentially deadly danger, especially for inexperienced drivers. Safety should be the first concern when behind the wheel and drivers need to be aware of the wide array of potential distractions, such as drowsiness, reaching for objects, eating, personal grooming, other passengers, and using cellular phones.

Drivers can become distracted when they take their eyes and attention off the road or their hands off the wheel to focus on activities other than driving. To reduce your risk of distraction and an accident:

- ALWAYS set up your mobile devices (i.e., MP3 players, phones, navigation units, etc.) when your vehicle is parked or safely stopped.
- ONLY use your mobile device when allowed by laws and conditions permit safe use. NEVER text or email while driving. Most countries have laws prohibiting drivers from texting. Some countries and cities also prohibit drivers from using handheld phones.

- NEVER let the use of a mobile device distract you from driving. You have a responsibility to your passengers and others on the road to always drive safely, with your hands on the wheel as well as your eyes and attention on the road.

Control your speed

Excessive speed is a major factor in crash injuries and deaths. Generally, the higher the speed, the greater the risk, but serious injuries can also occur at lower speeds. Never drive faster than is safe for current conditions, regardless of the maximum speed posted.

Keep your vehicle in safe condition

Having a tire blowout or a mechanical failure can be extremely hazardous. To reduce the possibility of such problems, check your tire pressures and condition frequently, and perform all regularly scheduled maintenance.

SEATS

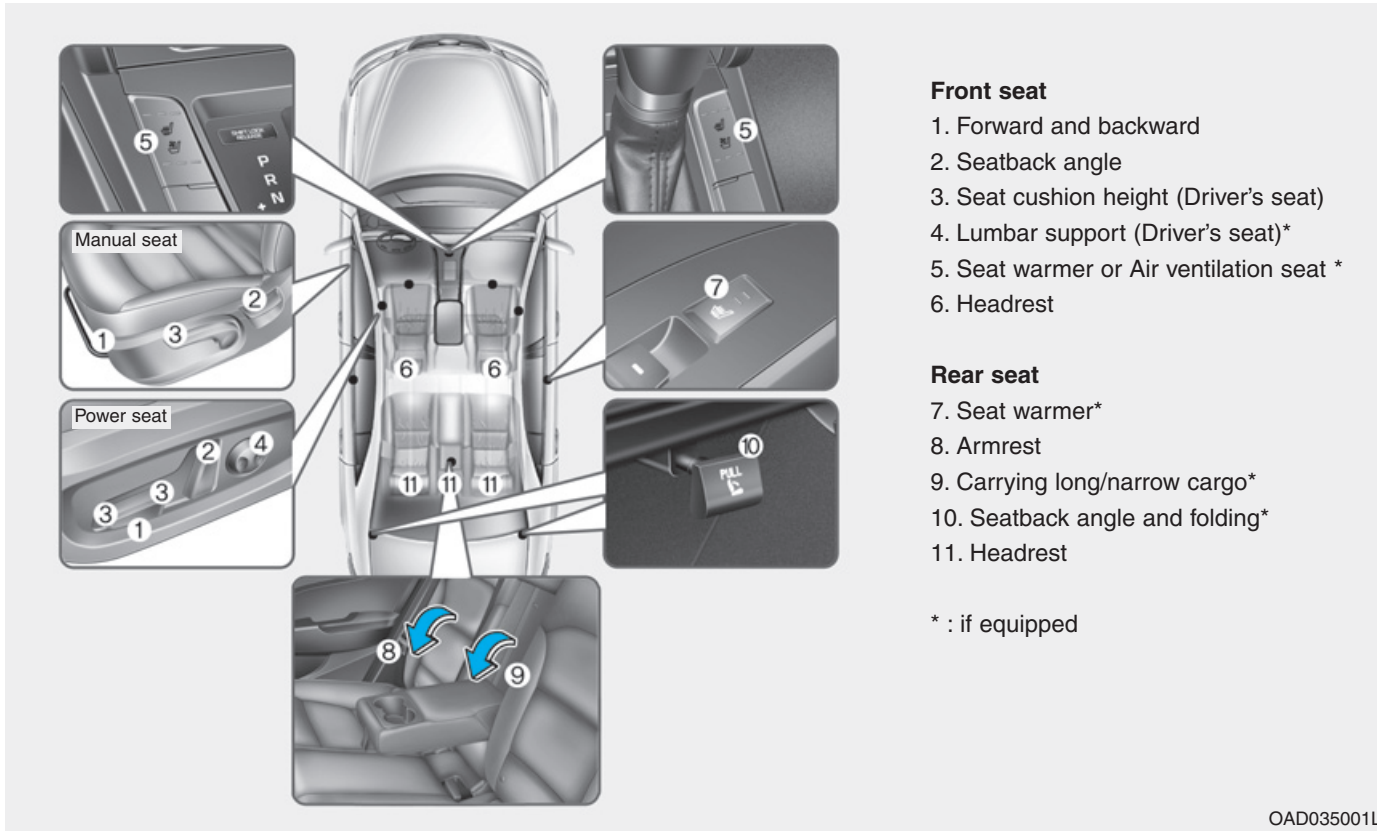

Front seat

1. Forward and backward
2. Seatback angle
3. Seat cushion height (Driver's seat)
4. Lumbar support (Driver's seat)*
5. Seat warmer or Air ventilation seat *
6. Headrest

Rear seat

7. Seat warmer*
8. Armrest
9. Carrying long/narrow cargo*
10. Seatback angle and folding*
11. Headrest

* : if equipped

Safety precautions

Adjusting the seats so that you are sitting in a safe, comfortable position plays an important role in driver and passenger safety together with the seat belts and air bags in an accident.

WARNING

Do not use a cushion that reduces friction between the seat and the passenger. The passenger's hips may slide under the lap portion of the seat belt during an accident or a sudden stop. Serious or fatal internal injuries could result because the seat belt cannot operate properly.

Air bags

You can take steps to reduce the risk of being injured by an inflating air bag. Sitting too close to an air bag greatly increases the risk of injury in the event the air bag inflates. Move your seat as far back as possible from front air bags, while still maintaining control of the vehicle.

WARNING

To reduce the risk of serious injury or death from an inflating air bag, take the following precautions:

- **Adjust the driver's seat as far to the rear as possible while maintaining the ability to maintain full control of the vehicle.**
- **Adjust the front passenger seat as far to the rear as possible.**

(Continued)

(Continued)

- **Hold the steering wheel by the rim with hands at the 9 o'clock and 3 o'clock positions to minimize the risk of injuries to your hands and arms.**
- **NEVER place anything or anyone between the air bag.**
- **Do not allow the front passenger to place feet or legs on the dashboard to minimize the risk of leg injuries.**

Seat belts

Always fasten your seat belt before starting any trip.

At all times, passengers should sit upright and be properly restrained. Infants and small children must be restrained in appropriate child restraint systems. Children who have outgrown a booster seat and adults must be restrained using the seat belts.

WARNING

Take the following precautions when adjusting your seat belt:

- NEVER use one seat belt for more than one occupant.
- Always position the seatback upright with the lap portion of the seat belt snug and low across the hips.
- NEVER allow children or small infants to ride in a passenger's lap.

(Continued)

(Continued)

- Do not route the seat belt across your neck, across sharp edges, or reroute the shoulder strap away from your body.
- Do not allow the seat belt to become caught or jammed.

Front seats

The front seat can be adjusted by using the control switches located on the outside of the seat cushion. Before driving, adjust the seat to the proper position so that you can easily control the steering wheel, foot pedals and controls on the instrument panel.

WARNING

Take the following precautions when adjusting your seat:

- NEVER attempt to adjust the seat while the vehicle is moving. The seat could respond with unexpected movement and may cause loss of vehicle control resulting in an accident.
- Do not place anything under the front seats. Loose objects in the driver's foot area could interfere with the operation of the foot pedals, causing an accident.

(Continued)

(Continued)

- Do not allow anything to interfere with the normal position and proper locking of the seat-back.
- Do not place a cigarette lighter on the floor or seat. When you operate the seat, gas may exit out of the lighter causing a fire.
- Use extreme caution when picking small objects trapped under the seats or between the seat and the center console. Your hands might be cut or injured by the sharp edges of the seat mechanism.
- If there are occupants in the rear seats, be careful while adjusting the front seat position.

CAUTION

To prevent injury:

- Do not adjust your seat while wearing your seat belt. Moving the seat cushion forward may cause strong pressure on your abdomen.
- Do not allow your hands or fingers to get caught in the seat mechanisms while the seat is moving.

Manual adjustment

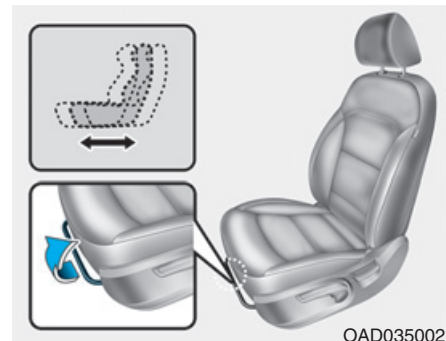

Forward and rearward adjustment

To move the seat forward or rearward:

1. Pull up the seat slide adjustment lever and hold it.
2. Slide the seat to the position you desire.
3. Release the lever and make sure the seat is locked in place. Move forward and rearward without using the lever. If the seat moves, it is not locked properly.

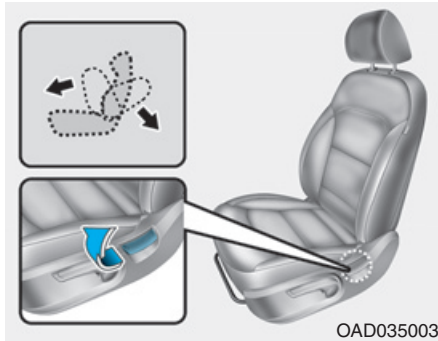

Seatback angle

To recline the seatback:

1. Lean forward slightly and lift up the seatback lever.
2. Carefully lean back on the seat and adjust the seatback to the position you desire.
3. Release the lever and make sure the seatback is locked in place. (The lever **MUST** return to its original position for the seatback to lock.)

Reclining seatback

Sitting in a reclined position when the vehicle is in motion can be dangerous. Even when buckled up, the protections of your restraint system (seat belts and/or air bags) is greatly reduced by reclining your seatback.

WARNING

NEVER ride with a reclined seatback when the vehicle is moving.

Riding with a reclined seatback increases your chance of serious or fatal injuries in the event of a collision or sudden stop.

Drivers and passengers should ALWAYS sit well back in their seats, properly belted, and with the seatbacks upright.

Seat belts must be snug against your hips and chest to work properly. When the seatback is reclined, the shoulder belt cannot do its job because it will not be snug against your chest. Instead, it will be in front of you. During an accident, you could be thrown into the seat belt, causing neck or other injuries.

The more the seatback is reclined, the greater chance the passenger's hips will slide under the lap belt or the passenger's neck will strike the shoulder belt.

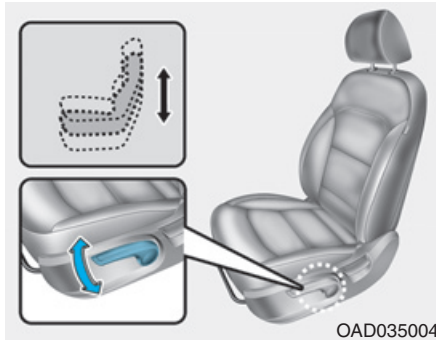

Seat cushion height (for front seats, if equipped)

To change the height of the seat cushion:

- Push down the lever several times, to lower the seat cushion.
- Pull up the lever several times, to raise the seat cushion.

Power adjustment

The front seat can be adjusted by using the control switches located on the outside of the seat cushion. Before driving, adjust the seat to the proper position so that you can easily control the steering wheel, foot pedals and controls on the instrument panel.

⚠ WARNING

NEVER allow children in the vehicle unattended. The power seats are operable when the engine is turned off.

⚠ CAUTION

To prevent damage to the seats:

- Always stop adjusting the seats when the seat has been adjusted as far forward or rearward as possible.
- Do not adjust the seats longer than necessary when the engine is turned off. This may result in unnecessary battery drain.
- Do not operate two or more seats at the same time. This may result in an electrical malfunction.

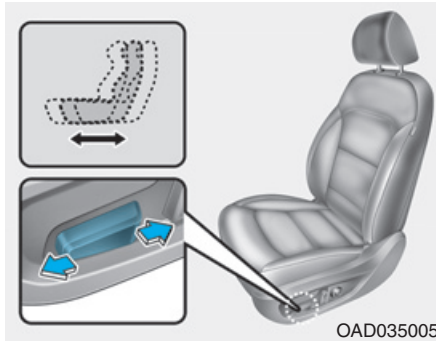

Forward and rearward adjustment

To move the seat forward or rearward:

1. Push the control switch forward or rearward.
2. Release the switch once the seat reaches the desired position.

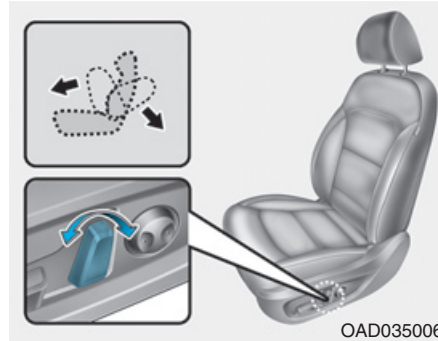

Seatback angle

To recline the seatback:

1. Push the control switch forward or rearward.
2. Release the switch once the seatback reaches the desired position.

Reclining seatback

Sitting in a reclined position when the vehicle is in motion can be dangerous. Even when buckled up, the protections of your restraint system (seat belts and air bags) is greatly reduced by reclining your seatback.

WARNING

NEVER ride with a reclined seatback when the vehicle is moving.

Riding with a reclined seatback increases your chance of serious or fatal injuries in the event of a collision or sudden stop.

Driver and passengers should ALWAYS sit well back in their seats, properly belted, and with the seatbacks upright.

Seat belts must be snug against your hips and chest to work properly. When the seatback is reclined, the shoulder belt cannot do its job because it will not be snug against your chest. Instead, it will be in front of you. During an accident, you could be thrown into the seat belt, causing neck or other injuries.

The more the seatback is reclined, the greater chance the passenger's hips will slide under the lap belt or the passenger's neck will strike the shoulder belt.

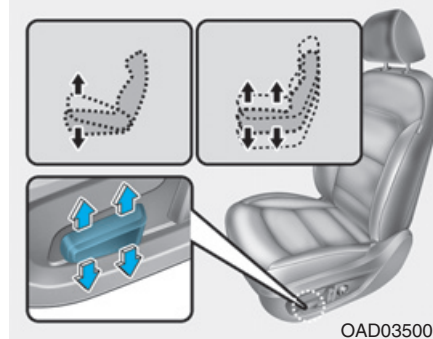

Seat cushion height

To change the height of the seat cushion:

1. Push the front portion of the control switch up to raise or down to lower the front part of the seat cushion.

Push the rear portion of the control switch up to raise or down to lower the height of the seat cushion.

2. Release the switch once the seat reaches the desired position.

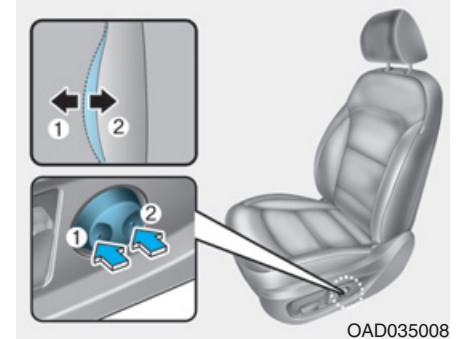

Lumbar support

- The lumbar support can be adjusted by pressing the lumbar support switch.
- Press the front portion of the switch (1) to increase support or the rear portion of the switch (2) to decrease support.

The lumbar support does not operate up or down when the lumbar support is in the rearmost position.

In this case, to use the system, slightly increase support by pushing the front portion of the switch (1).

Seatback pocket (if equipped)

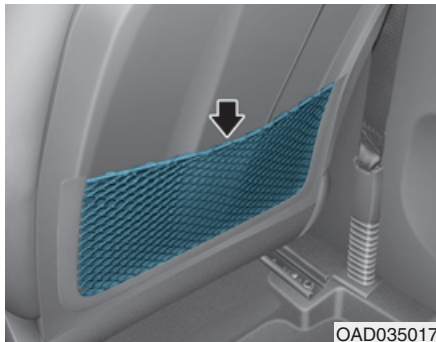

The seatback pocket is provided on the back of the front seatbacks.

CAUTION

Do not put heavy or sharp objects in the seatback pockets. In an accident they could come loose from the pocket and injure occupants.

Rear seats

Folding the rear seat (if equipped)

The rear seatbacks can be folded to facilitate carrying long items or to increase the luggage capacity of the vehicle.

WARNING

- Never allow passengers to sit on top of the folded down seatback while the vehicle is moving. This is not a proper seating position and no seat belts are available for use. This could result in serious injury or death in case of an accident or sudden stop.
- Objects carried on the folded down seatback should not extend higher than the top of the front seatbacks. This could allow cargo to slide forward and cause injury or damage during sudden stops.

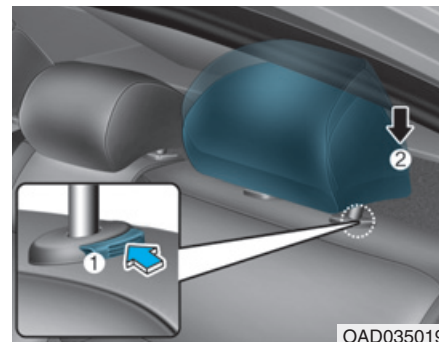

To fold down the rear seatback:

1. Set the front seatback to the upright position and if necessary, slide the front seat forward.
2. Lower the rear head restraints to the lowest position.

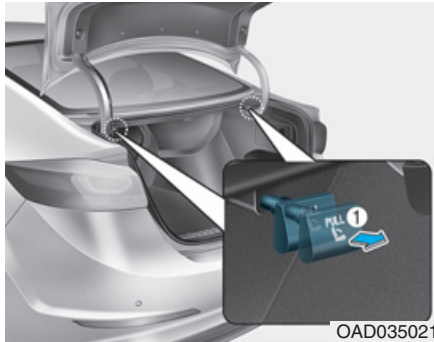

OAD035021

3. Pull on the seatback folding lever (1) located in the trunk.



OAD035022

4. Fold the seatback toward the front of the vehicle.
5. To use the rear seat, lift and pull the seatback rearward. Pull the seatback firmly until it clicks into place. Make sure the seatback is locked in place.

When you return the seatback to its upright position, always be sure it has locked into position by pushing on the top of the seatback.

WARNING

When returning the rear seatback from a folded to an upright position, hold the seatback and return it slowly. Ensure that the seatback is completely locked into its upright position by pushing on the top of the seatback. In an accident or sudden stop, the unlocked seatback could allow cargo to move forward with great force and enter the passenger compartment, which could result in serious injury or death.

WARNING

Do not place objects in the rear seats, since they cannot be properly secured and may hit vehicle occupants in a collision causing serious injury or death.

⚠ WARNING

Make sure the engine is off, the shift lever is in P (Park), and the parking brake is securely applied whenever loading or unloading cargo. Failure to take these steps may allow the vehicle to move if the shift lever is inadvertently moved to another position.

Armrest

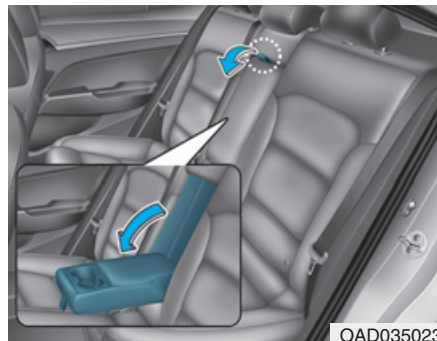

The armrest is located in the center of the rear seat. Pull the armrest down from the seatback to use it.

**Carrying long/narrow cargo
(if equipped)**

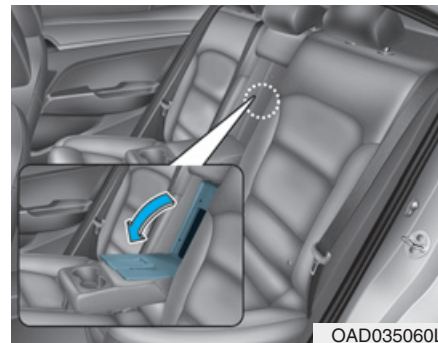

Additional cargo space is provided to accommodate long/narrow cargo (skis, poles, etc.) not able to fit properly in the trunk when closed.

1. Pull the armrest down.
2. Pull the cover down while pushing the release lever down.

 **CAUTION**

- Be careful when loading cargo through the rear passenger seats to prevent damage to the vehicle interior.
- When cargo is loaded through the rear passenger seats, ensure the cargo is properly secured to prevent it from moving while driving.

 **WARNING**

Cargo should always be secured to prevent it from being thrown about the vehicle in a collision and causing injury to the vehicle occupants. Do not place objects in the rear seats, since they cannot be properly secured and may hit the front seat occupants in a collision.

 **WARNING**

Cargo loading

Make sure the engine is off, the automatic transmission is in P (Park) and the parking brake is securely applied whenever loading or unloading cargo.

Failure to take these steps may allow the vehicle to move if the shift lever is inadvertently moved to another position.

Headrest

The vehicle's front and rear seats have adjustable headrests. The headrests provide comfort for passengers, but more importantly they are designed to help protect passengers from whiplash and other neck and spinal injuries during an accident, especially in a rear impact collision.

WARNING

To reduce the risk of serious injury or death in an accident, take the following precautions when adjusting your headrests:

- Always properly adjust the headrests for all passengers **BEFORE** starting the vehicle.
- **NEVER** let anyone ride in a seat with the headrest removed.

(Continued)

(Continued)



Adjust the headrests so the middle of the headrests is at the same height as the height of the top of the eyes.

- **NEVER** adjust the headrest position of the driver's seat when the vehicle is in motion.
- Adjust the headrest as close to the passenger's head as possible. Do not use a seat cushion that holds the body away from the seatback.
- Make sure the headrest locks into position after adjusting it.

NOTICE

To prevent damage, **NEVER** hit or pull on the headrests.

CAUTION

When there is no occupant in the rear seats, adjust the height of the headrest to the lowest position. The rear seat headrest can reduce the visibility of the rear area.

Front seat headrests

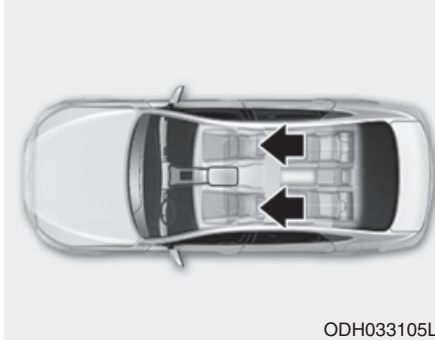

ODH033105L

The driver's and front passenger's seats are equipped with adjustable headrests for the passengers safety and comfort.

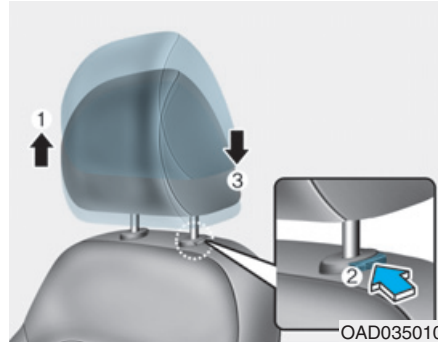

Adjusting the height up and down

To raise the headrest:

1. Pull it up to the desired position (1).

To lower the headrest:

1. Push and hold the release button (2) on the headrest support.
2. Lower the headrest to the desired position (3).

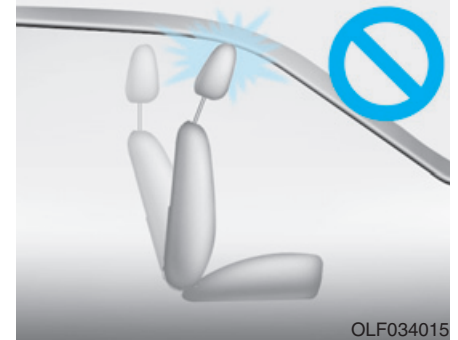

NOTICE

If you recline the seatback towards the front with the head restraint and seat cushion raised, the head restraint may come in contact with the sunvisor or other parts of the vehicle.

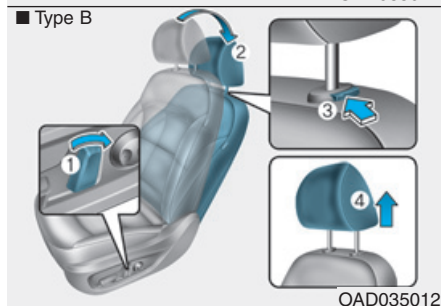
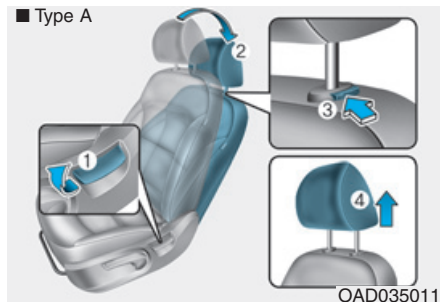

Removal/Reinstall

To remove the headrest:

1. Recline the seatback (2) with using the seatback angle switch (1).
2. Raise headrest as far as it can go.
3. Press the headrest release button (3) while pulling the headrest up (4).

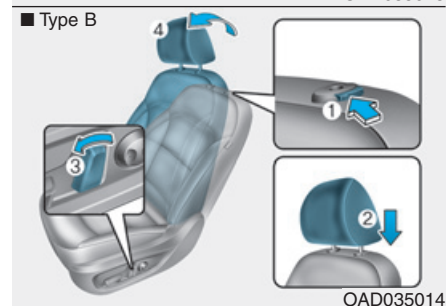
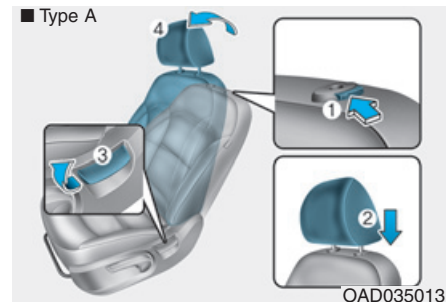

To reinstall the headrest :

1. Recline the seatback.
2. Put the headrest poles (2) into the holes while pressing the release button (1).
3. Adjust the headrest to the appropriate height.

4. Recline the seatback (4) with the seatback angle switch (3).

WARNING

Always make sure the headrest locks into position after re-installing and adjusting it properly.

Rear seat headrests

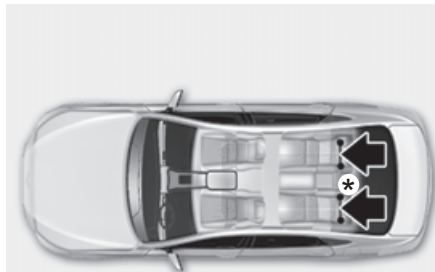

* : if equipped

ODH033106L

The rear seats are equipped with headrests in all the seating positions for the passenger's safety and comfort.

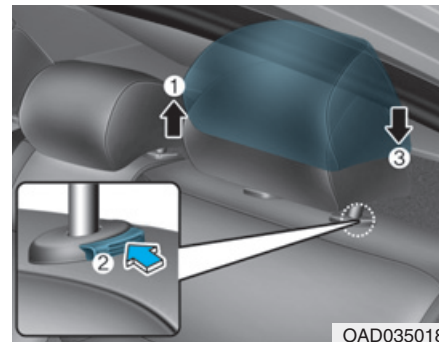

Adjusting the height up and down (if equipped)

To raise the headrest:

1. Pull it up to the desired position (1).

To lower the headrest:

1. Push and hold the release button (2) on the headrest support.
2. Lower the headrest to the desired position (3).

Seat warmers and air ventilation seats

Front seat warmers (if equipped)

Seat warmers are provided to warm the seats during cold weather.

WARNING

The seat warmers can cause a **SERIOUS BURN**, even at low temperatures and especially if used for long periods of time.

Passengers must be able to feel if the seat is becoming too warm so they can turn it off, if needed.

People who cannot detect temperature change or pain to the skin should use extreme caution, especially the following types of passengers:

- Infants, children, elderly or disabled persons, or hospital outpatients.
- People with sensitive skin or who burn easily.
- Fatigued individuals.

(Continued)

(Continued)

- Intoxicated individuals.
- People taking medication that can cause drowsiness or sleepiness.

WARNING

NEVER place anything on the seat that insulates against heat when the seat warmer is in operation, such as a blanket or seat cushion. This may cause the seat warmer to overheat, causing a burn or damage to the seat.

NOTICE

To prevent damage to the seat warmers and seats:

- Never use a solvent such as paint thinner, benzene, alcohol or gasoline to clean the seats.
- Do not place heavy or sharp objects on seats equipped with seat warmers.
- Do not change the seat cover. It may damage the seat warmer or air ventilation system.

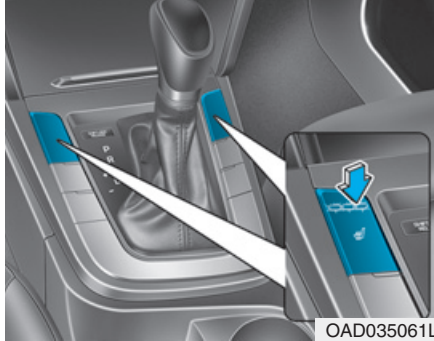

While the engine is running, push either of the switches to warm the driver's seat or front passenger's seat.

During mild weather or under conditions where the operation of the seat warmer is not needed, keep the switches in the OFF position.

- Each time you push the switch, the temperature setting of the seat is changed as follows :

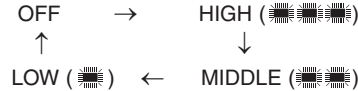

- When pressing the switch for more than 1.5 seconds with the seat warmer operating, the seat warmer will turn OFF.
- The seat warmer defaults to the OFF position whenever the ignitions switch is in the ON position.

i Information

With the seat warmer switch in the ON position, the heating system in the seat turns off or on automatically depending on the seat temperature.

Seat warmers and air ventilation seats (if equipped)

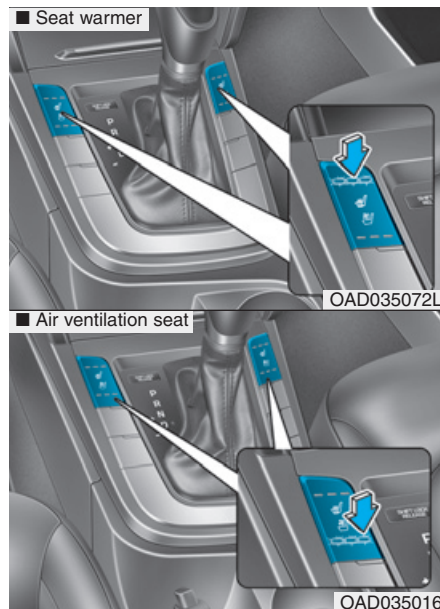

The seat warmers and air ventilation seats are provided to warm or cool the front seats by blowing air through small vent holes on the surface of the seat cushions and seatbacks.

When the operation of the seat warmers or air ventilation seat are not needed, keep the switches in the OFF position.

While the engine is running, push the switch to warm or cool the driver's seat or the front passenger's seat (if equipped).

- Each time you push the switch, the airflow changes as follows:

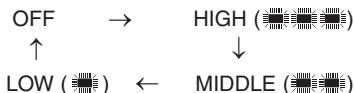

- When pressing the switch for more than 1.5 seconds with the seat warmer or air ventilation seat operating, the seat warmer will turn OFF.
- The seat warmers or air ventilation seats defaults to the OFF position whenever the ignition switch is placed to the ON position.

i Information

With the seat warmer switch in the ON position, the heating system in the seat turns off or on automatically depending on the seat temperature.

⚠️ CAUTION

To prevent damage to the seat warmer, air ventilation seat and seats:

- Use the seat warmer and air ventilation seat **ONLY** when the climate control system is on. Using the seat warmer and air ventilation seat for prolonged periods of time with the climate control system off could cause the seat warmer and air ventilation seat to malfunction.
- Never use a solvent such as paint thinner, benzene, alcohol or gasoline to clean the seats.

(Continued)

(Continued)

- Avoid spilling liquids on the surface of the front seats and seatbacks; this may cause the air vent holes to become blocked and not work properly.
- Do not place materials such as plastic bags or newspapers under the seats. They may block the air intake causing the air vents to not work properly.
- Do not change the seat covers. It may damage the seat warmer or air ventilation seat.
- If the air vents do not operate, restart the vehicle. If there is no change, we recommend that you have your vehicle inspected by an authorized HYUNDAI dealer.

Rear seat warmers (if equipped)



While the engine is running, push either of the switches to warm the rear seat.

During mild weather or under conditions where the operation of the seat warmer is not needed, keep the switches in the OFF position.

Each time you push the switch, the temperature setting of the seat is changed as follows :

OFF → HIGH (☀️☀️☀️) → LOW (☀️)
 ↑—————↓

The seat warmer defaults to the OFF position whenever the ignition switch is placed in the ON position.

i Information

With the seat warmer switch in the ON position, the heating system in the seat turns off or on automatically depending on the seat temperature.

SEAT BELTS

This section describes how to use the seat belts properly. It also describes some of the things not to do when using seat belts.

Seat belt safety precautions

Always fasten your seat belt and make sure all passengers have fastened their seat belts before starting any trip. Air bags (if equipped) are designed to supplement the seat belt as an additional safety device, but they are not a substitute. Most countries require all occupants of a vehicle to wear seat belts.

WARNING

Seat belts must be used by ALL passengers whenever the vehicle is moving. Take the following precautions when adjusting and wearing seat belts:

- **ALWAYS** properly restrain children under age 13 in the rear seats.
- **NEVER** allow children to ride in the front passenger seat. If a child age 13 or older must be seated in the front seat, move the seat as far back as possible and properly restrain them in the seat.
- **NEVER** allow an infant or child to be carried on an occupant's lap.
- **NEVER** ride with the seatback reclined when the vehicle is moving.
- Do not allow children to share a seat or seat belt.

(Continued)

(Continued)

- Do not wear the shoulder belt under your arm or behind your back.
- Never wear a seat belt over fragile objects. If there is a sudden stop or impact, the seat belt can damage it.
- Do not use the seat belt if it is twisted. A twisted seat belt will not protect you properly in an accident.
- Do not use a seat belt if the webbing or hardware is damaged.
- Do not latch the seat belt into the buckles of other seats.
- **NEVER** unfasten the seat belt while driving. This may cause loss of vehicle control resulting in an accident.
- Make sure there is nothing in the buckle interfering with the seat belt latch mechanism. This may prevent the seat belt from fastening securely.

(Continued)

(Continued)

- No modifications or additions should be made by the user which will either prevent the seat belt adjusting devices from operating to remove slack, or prevent the seat belt assembly from being adjusted to remove slack.

⚠ WARNING

Damaged seat belts and seat belt assemblies will not operate properly. Always replace:

- Frayed, contaminated, or damaged webbing.
- Damaged hardware.
- The entire seat belt assembly after it has been worn in an accident, even if damage to webbing or assembly is not apparent.

Seat belt warning light

Seat belt warning

■ For driver in instrument cluster



As a reminder to the driver, the driver's seat belt warning lights will illuminate for approximately 6 seconds each time you place the ignition switch ON regardless of belt fastening.

If the driver's seat belt is not fastened when the ignition switch is placed in the ON position or if it is disconnected after the ignition switch is placed in the ON position, the corresponding seat belt warning light will illuminate until the belt is fastened.

If you continue not to fasten the seat belt and you drive over 9 km/h (5 mph), the warning light will illuminate until you drive under 6 km/h (3 mph).

If you continue not to fasten the seat belt and you drive over 20 km/h (12 mph) the seat belt warning chime will sound for approximately 100 seconds and the corresponding warning light will blink.

⚠ WARNING

Riding in an improper position adversely affects the front passenger's seat belt warning system. It is important for the driver to instruct the passenger as to the proper seating instructions as contained in this manual.

Seat belt restraint system

Lap/shoulder belt

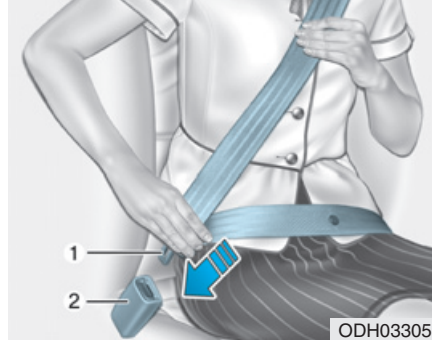

To fasten your seat belt:

Pull it out of the retractor and insert the metal tab (1) into the buckle (2). There will be an audible "click" when the tab locks into the buckle.

The seat belt automatically adjusts to the proper length after the lap belt portion is adjusted manually so that it fits snugly around your hips. If you lean forward in a slow, easy motion, the belt will extend and move with you. If there is a sudden stop or impact, the belt will lock into position. It will also lock if you try to lean forward too quickly.

NOTICE

If you are not able to smoothly pull enough of the seat belt out from the retractor, firmly pull the seat belt out and release it. After release, you will be able to pull the belt out smoothly.

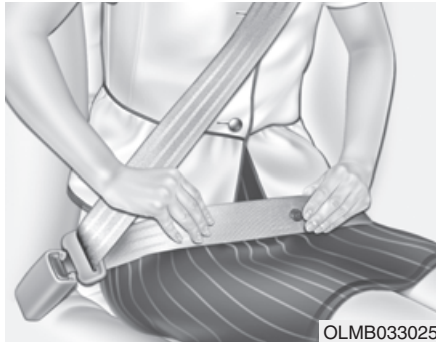

OLMB033025

WARNING

Improperly positioned seat belts may increase the risk of serious injury in an accident. Take the following precautions when adjusting the seat belt:

- **Position the lap portion of the seat belt as low as possible across your hips, not on your waist, so that it fits snugly. This allows your strong pelvic bones to absorb the force of the crash, reducing the chance of internal injuries.**

(Continued)

(Continued)

- **Position one arm under the shoulder belt and the other over the belt, as shown in the illustration.**
- **Always position the shoulder belt anchor into locked position at the appropriate height.**
- **Never position the shoulder belt across your neck or face.**

Height adjustment

You can adjust the height of the shoulder belt anchor to one of the four different positions for maximum comfort and safety.

The shoulder portion should be adjusted so it lies across your chest and midway over your shoulder nearest the door, not over your neck.

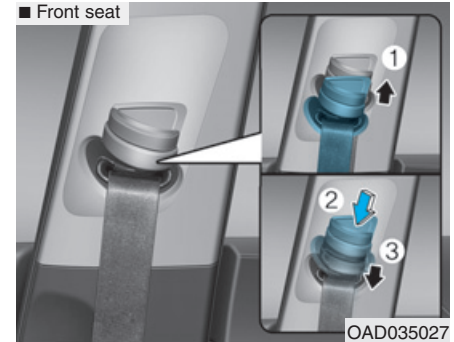

■ Front seat

OAD035027

To adjust the height of the seat belt anchor, lower or raise the height adjuster into an appropriate position.

To raise the height adjuster, pull it up (1). To lower it, push it down (3) while pressing the height adjuster button (2).

Release the button to lock the anchor into position. Try sliding the height adjuster to make sure that it has locked into position.

Rear center seatbelt

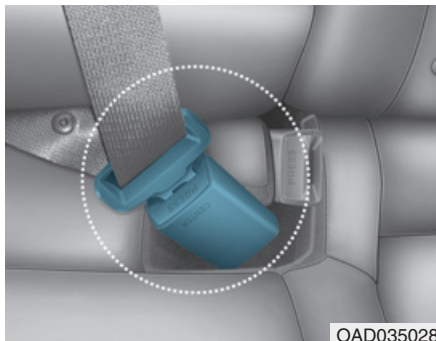

When using the rear center seat belt, the buckle with the “CENTER” mark must be used.

⚠ WARNING

Always have the metal tab inserted into the buckle.

i Information

If you are not able to pull out the safety belt from the retractor, firmly pull the belt out and release it. After release, you will be able to pull the belt out smoothly.

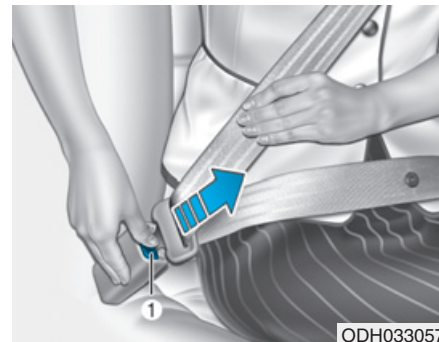

To release your seat belt:

Press the release button (1) in the locking buckle.

When it is released, the belt should automatically draw back into the retractor. If this does not happen, check the belt to be sure it is not twisted, then try again.

Pre-tensioner seat belt (Driver and front passenger, if equipped)



ODH033058

Your vehicle is equipped with driver's and front passenger's Pre-tensioner Seat Belts. The purpose of the pre-tensioner is to make sure the seat belts fit tightly against the occupant's body in certain frontal collisions. The pre-tensioner seat belts may be activated in crashes where the frontal collision is severe enough, together with the air bags.

When the vehicle stops suddenly, or if the occupant tries to lean forward too quickly, the seat belt retractor will lock into position. In certain frontal collisions, the pre-tensioner will activate and pull the seat belt into tighter contact against the occupant's body.

⚠ WARNING

- Always wear your seat belt and sit properly in your seat.
- Do not use the seat belt if it is loose or twisted. A loose or twisted seat belt will not protect you properly in an accident.
- Do not place anything near the buckle. This may adversely affect the buckle and cause it to function improperly.
- Always replace your pre-tensioners after activation or an accident.
- NEVER inspect, service, repair or replace the pre-tensioners yourself. This must be done by an authorized HYUNDAI dealer.

(Continued)

(Continued)

- Do not hit the seat belt assemblies.

⚠ WARNING

Do not touch the pre-tensioner seat belt assemblies for several minutes after they have been activated. When the pre-tensioner seat belt mechanism deploys during a collision, the pre-tensioner can become hot and can burn you.

⚠ CAUTION

Body work on the front area of the vehicle may damage the pre-tensioner seat belt system. Therefore, we recommend that the system be serviced by an authorized HYUNDAI dealer.

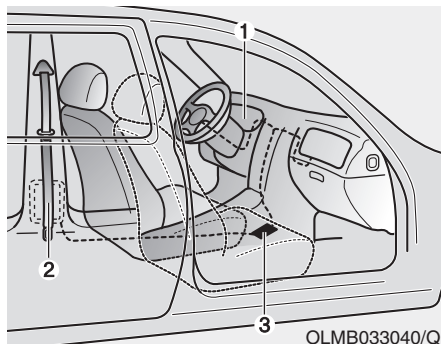

The Pre-Tensioner Seat Belt System consists mainly of the following components. Their locations are shown in the illustration above:

- (1) SRS air bag warning light
- (2) Retractor pre-tensioner
- (3) SRS control module

NOTICE

The sensor that activates the SRS air bag is connected with the pre-tensioner seat belts. The SRS air bag warning light on the instrument panel will illuminate for approximately 6 seconds after the ignition switch is placed to the ON position, and then it should turn off.

If the pre-tensioner is not working properly, the warning light will illuminate even if the SRS air bag is not malfunctioning. If the warning light does not illuminate, stays illuminated or illuminates when the vehicle is being driven, we recommend the pre-tensioner seat belts and/or SRS air bags be inspected by an authorized HYUNDAI dealer as soon as possible.

NOTICE

- Both the driver's and front passenger's pre-tensioner seat belts may be activated in certain frontal or side collisions.
- The pre-tensioners will be activated even if the seat belts are not worn at the time of the collision.
- When the pre-tensioner seat belts are activated, a loud noise may be heard and fine dust, which may appear to be smoke, may be visible in the passenger compartment. These are normal operating conditions and are not hazardous.
- Although it is non-toxic, the fine dust may cause skin irritation and should not be breathed for prolonged periods. Wash all exposed skin areas thoroughly after an accident in which the pre-tensioner seat belts were activated.

Additional seat belt safety precautions

Seat belt use during pregnancy

The seat belt should always be used during pregnancy. The best way to protect your unborn child is to protect yourself by always wearing the seat belt.

Pregnant women should always wear a lap-shoulder seat belt. Place the shoulder belt across your chest, routed between your breasts and away from your neck. Place the lap belt below your belly so that it fits **SNUGLY** across your hips and pelvic bone, under the rounded part of the belly.

⚠ WARNING

To reduce the risk of serious injury or death to an unborn child during an accident, pregnant women should **NEVER** place the lap portion of the seat belt above or over the area of the abdomen where the unborn child is located.

Seat belt use and children

Infant and small children

Most countries have child restraint laws which require children to travel in approved child restraint devices, including booster seats. The age at which seat belts can be used instead of child restraints differs among countries, so you should be aware of the specific requirements in your country, and where you are travelling. Infant and child restraints must be properly placed and installed in a rear seat. For more information refer to the “Child Restraint Systems” in this chapter.

⚠ WARNING

ALWAYS properly restrain infants and small children in a child restraint appropriate for the child’s height and weight.

(Continued)

(Continued)

To reduce the risk of serious injury or death to a child and other passengers, **NEVER** hold a child in your lap or arms when the vehicle is moving. The violent forces created during an accident will tear the child from your arms and throw the child against the interior of the vehicle.

Small children are best protected from injury in an accident when properly restrained in the rear seat by a child restraint system that meets the requirements of the Safety Standards of your country. Before buying any child restraint system, make sure that it has a label certifying that it meets Safety Standard of your country. The restraint must be appropriate for your child’s height and weight. Check the label on the child restraint for this information. Refer to “Child Restraint Systems” in this chapter.

Larger children

Children under age 13 and who are too large for a booster seat must always occupy the rear seat and use the available lap/shoulder belts. A seat belt should lie across the upper thighs and be snug across the shoulder and chest to restrain the child safely. Check belt fit periodically. A child's squirming could put the belt out of position. Children are afforded the most safety in the event of an accident when they are restrained by a proper restraint system and/or seat belts in the rear seat.

If a larger child over age 13 must be seated in the front seat, the child must be securely restrained by the available lap/shoulder belt and the seat should be placed in the rear-most position.

If the shoulder belt portion slightly touches the child's neck or face, try placing the child closer to the center of the vehicle. If the shoulder belt still touches their face or neck, they need to be returned to an appropriate booster seat in the rear seat.

WARNING

- **Always make sure larger children's seat belts are worn and properly adjusted.**
- **NEVER allow the shoulder belt to contact the child's neck or face.**
- **Do not allow more than one child to use a single seat belt.**

Seat belt use and injured people

A seat belt should be used when an injured person is being transported. Consult a physician for specific recommendations.

One person per belt

Two people (including children) should never attempt to use a single seat belt. This could increase the severity of injuries in case of an accident.

Do not lie down

Sitting in a reclined position when the vehicle is in motion can be dangerous. Even when buckled up, the protections of your restraint system (seat belts and/or air bags) is greatly reduced by reclining your seatback.

Seat belts must be snug against your hips and chest to work properly. During an accident, you could be thrown into the seat belt, causing neck or other injuries.

The more the seatback is reclined, the greater chance the passenger's hips will slide under the lap belt or the passenger's neck will strike the shoulder belt.

 **WARNING**

- **NEVER ride with a reclined seatback when the vehicle is moving.**
- **Riding with a reclined seatback increases your chance of serious or fatal injuries in the event of a collision or sudden stop.**
- **Driver and passengers should always sit well back in their seats, properly belted, and with the seatbacks upright.**

Care of seat belts

Seat belt systems should never be disassembled or modified. In addition, care should be taken to assure that seat belts and belt hardware are not damaged by seat hinges, doors or other abuse.

Periodic inspection

All seat belts should be inspected periodically for wear or damage of any kind. Any damaged parts should be replaced as soon as possible.

Keep belts clean and dry

Seat belts should be kept clean and dry. If belts become dirty, they can be cleaned by using a mild soap solution and warm water. Bleach, dye, strong detergents or abrasives should not be used because they may damage and weaken the fabric.

When to replace seat belts

The entire seat belt assembly or assemblies should be replaced if the vehicle has been involved in an accident. This should be done even if no damage is visible. We recommend that you consult an authorized HYUNDAI dealer.

CHILD RESTRAINT SYSTEM (CRS)

Children always in the rear

WARNING

Always properly restrain children in the rear seats of the vehicle, unless the air bag on the front passenger seat is deactivated.

Children of all ages are safer when restrained in the rear seat. A child riding in the front passenger seat can be forcefully struck by an inflating air bag resulting in SERIOUS INJURY or DEATH.

Children under age 13 must always ride in the rear seats and must always be properly restrained to minimize the risk of injury in an accident, sudden stop or sudden maneuver. According to accident statistics, children are safer when properly restrained in the rear seats than in the front seat. Children too large for a Child Restraint System must use the seat belts provided.

Most countries have Child Restraint Systems which require children to travel in approved Child Restraint Systems. The laws governing the age or height/weight restrictions at which seat belts can be used instead of Child Restraint System differs among countries, so you should be aware of the specific requirements in your country, and where you are travelling.

Child Restraint Systems must be properly placed and installed in the rear seat. You must use a commercially available Child Restraint System that meets the requirements of the Safety Standards of your country.

Child Restraint Systems are generally designed to be secured in a vehicle seat by lap belt or the lap belt portion of a lap/shoulder belt, or by a top-tether and/or ISOFIX anchorage in the rear seats of the vehicle.

Child Restraint System (CRS) always in the rear

Infants and younger children must be restrained in an appropriate rearward-facing or forward-facing CRS that has first been properly secured to the rear seat of the vehicle. Read and comply with the instructions for installation and use provided by the manufacturer of the Child Restraint System.

WARNING

- **Always follow the Child Restraint System manufacturer's instructions for installation and use.**
- **Always properly restrain your child in the Child Restraint System.**
- **Do not use an infant carrier or a child safety seat that "hooks" over a seatback, it may not provide adequate protection in an accident.**
- **After an accident, we recommend a HYUNDAI dealer check the Child Restraint System, seat belts, ISOFIX anchorages and top-tether anchorages.**

Selecting a Child Restraint System (CRS)

When selecting a CRS for your child, always:

- Make sure the CRS has a label certifying that it meets applicable Safety Standards of your country.
- Select a Child Restraint System based on your child's height and weight. The required label or the instructions for use typically provide this information.
- Select a Child Restraint System that fits the vehicle seating position where it will be used.
- Read and comply with the warnings and instructions for installation and use provided with the Child Restraint System.

Child Restraint System types

There are three main types of Child Restraint Systems: rearward-facing seats, forward-facing seats, and booster seats. They are classified according to the child's age, height and weight.

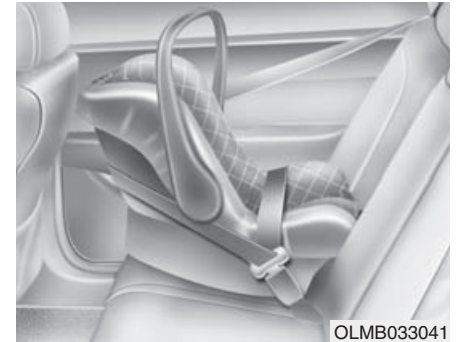

Rearward-facing Child Restraint System

A rearward-facing Child Restraint System provides restraint with the seating surface against the back of the child. The harness system holds the child in place, and in an accident, acts to keep the child positioned in the Child Restraint Systems and reduce the stress to the fragile neck and spinal cord.

All children under the age of one year must always ride in a rearward-facing Child Restraint System. There are different types of rearward-facing Child Restraint Systems: infant-only Child Restraint Systems can only be used rearward-facing. Convertible and 3-in-1 Child Restraint Systems typically have higher height and weight limits for the rearward-facing position, allowing you to keep your child rearward-facing for a longer period of time.

Keep using Child Restraint Systems in the rearward-facing position as long as children fit within the height and weight limits allowed by the Child Restraint System's manufacturer.



Forward-facing Child Restraint System

A forward-facing Child Restraint System provides restraint for the child's body with a harness. Keep children in a forward-facing Child Restraint System with a harness until they reach the top height or weight limit allowed by your Child Restraint System's manufacturer.

Once your child outgrows the forward-facing Child Restraint System, your child is ready for a booster seat.

Booster seats

A booster seat is Child Restraint System designed to improve the fit of the vehicle's seat belt system. A booster seat positions the seat belt so that it fits properly over the stronger parts of your child's body. Keep your children in booster seats until they are big enough to fit in a seat belt properly.

For a seat belt to fit properly, the lap belt must lie comfortable across the upper thighs, not the stomach. The shoulder belt should lie comfortable across the shoulder and chest and not across the neck or face. Children under age 13 must always be properly restrained to minimize the risk of injury in an accident, sudden stop or sudden maneuver.

Installing a Child Restraint System (CRS)

WARNING

Before installing your Child Restraint System always:

Read and follow the instructions provided by the manufacturer of the Child Restraint System.

Failure to follow all warnings and instructions could increase the risk of the SERIOUS INJURY or DEATH if an accident occurs.

WARNING

If the vehicle headrest prevents proper installation of a Child Restraint System, the headrest of the respective seating position shall be readjusted or entirely removed.

After selecting a proper Child Restraint System and checking that the Child Restraint System fits properly in the rear of this vehicle, you are ready to install the Child Restraint System according to the manufacturer's instruction. There are three general steps in installing the Child Restraint Systems properly:

- **Properly secure the Child Restraint System to the vehicle.** All Child Restraint System must be secured to the vehicle with the lap belt or lap part of a lap/shoulder belt or with the ISOFIX top-tether and/or ISOFIX anchorage.
- **Make sure the Child Restraint System is firmly secured.** After installing a Child Restraint System to the vehicle, push and pull the seat forward and from side-to-side to verify that it is securely attached to the seat. A Child Restraint System secured with a seat belt should be installed as firmly as possible. However, some side-to-side movement can be expected.

When installing a Child Restraint System, adjust the vehicle seat (up and down, forward and rearward) so that your child fits in the Child Restraint System in a comfortable manner.

- **Secure the child in the Child Restraint System.** Make sure the child is properly strapped in the Child Restraint System according to the Child Restraint System manufacturer's instructions.

CAUTION

A Child Restraint System in a closed vehicle can become very hot. To prevent burns, check the seating surface and buckles before placing your child in the Child Restraint System.

ISOFIX anchorage and top-tether anchorage (ISOFIX anchorages system) for children

The ISOFIX system holds a Child Restraint System during driving and in an accident. This system is designed to make installation of the Child Restraint System easier and reduce the possibility of improperly installing your Child Restraint System. The ISOFIX system uses anchors in the vehicle and attachments on the Child Restraint System. The ISOFIX system eliminates the need to use seat belts to secure the Child Restraint System to the rear seats.

ISOFIX anchorages are metal bars built into the vehicle. There are two lower anchors for each ISOFIX seating position that will accommodate a Child Restraint System with lower attachments.

To use the ISOFIX system in your vehicle, you must have a Child Restraint System with ISOFIX attachments. (An ISOFIX Child Restraint System may only be installed if it has vehicle-specific or universal approval in accordance with the requirements of ECE-R44 or ECE-R129.)

The Child Restraint System manufacturer will provide you with instructions on how to use the Child Restraint System with its attachments for the ISOFIX anchorages.

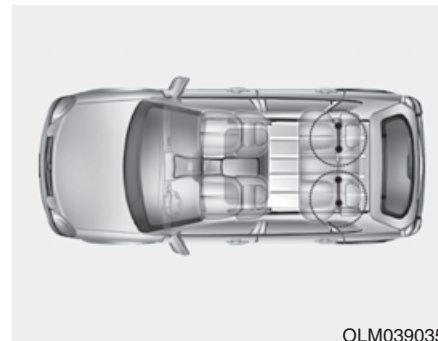

OLM039035

ISOFIX anchorages have been provided in the left and right outboard rear seating positions. Their locations are shown in the illustration. There are no ISOFIX anchorages provided for the center rear seating position.

⚠ WARNING

Do not attempt to install a Child Restraint System using ISOFIX anchorages in the rear center seating position. There are no ISOFIX anchorages provided for this seat. Using the outboard seat anchorages, for the CRS installation on the rear center seating position, can damage the anchorages.

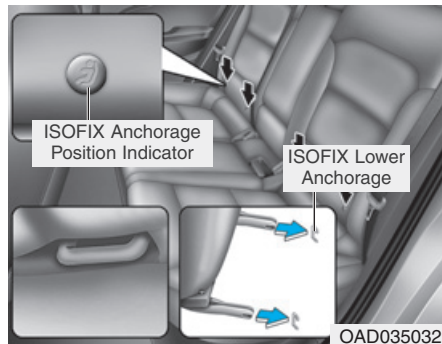

The ISOFIX anchorages symbols are located on the left and right rear seat cushions to identify the position of the ISOFIX anchorages in your vehicle (see arrows in illustration).

Both rear outboard seats are equipped with a pair of ISOFIX anchorages as well as a corresponding top-tether anchorage on the back side of the rear seats.

(Child Restraint Systems with universal approval according to ECE-R44 or ECE-R129 need to be fixed additionally with a top-tether connected to the back side of the rear seats.)

ISOFIX anchorages are located between the seatback and the seat cushion of the rear seat left and right outboard seating positions.

To use the ISOFIX anchorages, push the upper portion of the ISOFIX anchorage cover.

Securing a Child Restraint System with the “ISOFIX Anchorage System”

To install a ISOFIX-compatible Child Restraint System in either of the rear outboard seating positions:

1. Move the seat belt buckle away from the ISOFIX anchorages.
2. Move any other objects away from the anchors that could prevent a secure connection between the Child Restraint System and the ISOFIX anchorages.
3. Place the Child Restraint System on the vehicle seat, then attach the seat to the ISOFIX anchorages according to the instructions provided by the Child Restraint System manufacturer.
4. Follow the instructions of the Child Restraint System's manufacturer for proper installation and connection of the ISOFIX attachments on the Child Restraint System to the ISOFIX anchorages.

⚠ WARNING

Take the following precautions when using the ISOFIX system:

- **Read and follow all installation instructions provided with your Child Restraint System.**
- **To prevent the child from reaching and taking hold of unretracted seat belts, buckle all unused rear seat belts and retract the seat belt webbing behind the child. Children can be strangled if a shoulder belt becomes wrapped around their neck and the seat belt tightens.**
- **NEVER attach more than one Child Restraint System to a single anchorage. This could cause the anchor or attachment to come loose or break.**

(Continued)

(Continued)

- **Always have the ISOFIX system inspected by your dealer after an accident. An accident can damage the ISOFIX system and may not properly secure the Child Restraint System.**

Securing a Child Restraint System seat with “Top-tether Anchorage” system

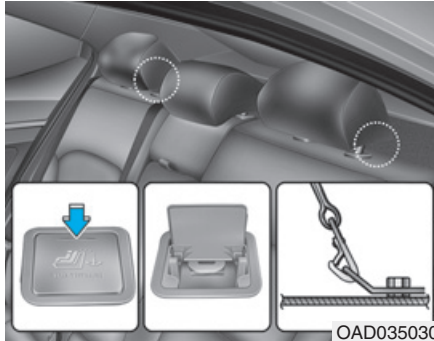

Child Restraint hook holders are located on the package tray.



1. Route the Child Restraint System seat strap over the seatback.

For vehicles with adjustable headrest, route the tether strap under the headrest and between the headrest posts, otherwise route the tether strap over the top of the seatback.

2. Connect the top-tether to the top-tether anchorage, then tighten the top-tether according to the instructions of your Child Restraint System's manufacturer to firmly attach the Child Restraint System to the seat.

WARNING

Take the following precautions when installing the top-tether:

- Read and follow all installation instructions provided with your Child Restraint System.
- **NEVER** attach more than one Child Restraint System to a single ISOFIX top-tether anchorage. This could cause the anchorage or attachment to come loose or break.
- Do not attach the top-tether to anything other than the correct top-tether anchorage. It may not work properly if attached to something else.
- Child Restraint anchorages are designed to withstand only those loads imposed by correctly fitted Child Restraint System.

Under no circumstances are they to be used for adult seat belts or harnesses or for attaching other items or equipment to the vehicle.

Child Seat Restraint for Vehicle ISOFIX Positions

Suitability of each seating position for ISOFIX Child Restraint Systems according to ECE regulations.

Mass Group	Size Class	Fixture	Vehicle ISOFIX Positions			
			Front Passenger	Rear Outboard (Driver side)	Rear Outboard (Passenger side)	Rear Center
Carrycot	F	ISO/L1	-	X	X	-
	G	ISO/L2	-	X	X	-
0 : UP to 10kg	E	ISO/R1	-	IL	IL	-
0+ : UP to 13kg	E	ISO/R1	-	IL	IL	-
	D	ISO/R2	-	IL	IL	-
	C	ISO/R3	-	IL	IL	-
I : 9 to 18kg	D	ISO/R2	-	IL	IL	-
	C	ISO/R3	-	IL	IL	-
	B	ISO/F2	-	IUF, IL	IUF, IL	-
	B1	ISO/F2X	-	IUF, IL	IUF, IL	-
	A	ISO/F3	-	IUF, IL	IUF, IL	-

IUF = Suitable for ISOFIX forward child restraints systems of universal category approved for use in the mass group.

IL = Suitable for particular ISOFIX child restraints systems (CRS) given in the attached list. These ISOFIX CRS are those of the "specific vehicle", "restricted" or "semi-universal" categories.

X = ISOFIX position not suitable for ISOFIX child restraint system in this mass group and/or this size class.

Securing a Child Restraint System with a lap/shoulder belt

When not using the ISOFIX system, all Child Restraint Systems must be secured to a rear seat with the lap part of a lap/shoulder belt.

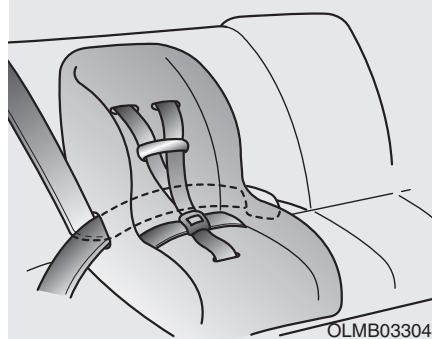

Installing a Child Restraint System with a lap/shoulder belt

To install a Child Restraint System on the rear seats, do the following:

1. Place the Child Restraint System on a rear seat and route the lap/shoulder belt around or through the restraint, following the restraint manufacturer's instructions.

Make sure the seat belt webbing is not twisted.

***i* Information**

When using the rear center seat belt, you should also refer to the “3-point Rear Center Seat Belt” in this chapter.



2. Fasten the lap/shoulder belt latch into the buckle. Listen for the distinct “click” sound.

i Information

Position the release button so that it is easy to access in case of an emergency.



3. Remove as much slack from the belt as possible by pushing down on the Child Restraint System while feeding the shoulder belt back into the retractor.
4. Push and pull on the Child Restraint System to confirm that the seat belt is holding it firmly in place.

If your CRS manufacturer instructs or recommends you use a ISOFIX top-tether anchorage with the lap/shoulder belt, see page 2-41.

To remove the Child Restraint System, press the release button on the buckle and then pull the lap/shoulder belt out of the restraint and allow the seat belt to retract fully

Child Seat Restraint Suitability for Seat Position using the Seat Belt

Suitability of each seating position for "universal" category belted Child Restraint Systems according to ECE regulations
 Use Child Restraint Systems that have been officially approved and are appropriate for your children.

When using the Child Restraint Systems, refer to the following table.

Mass Group	Seating Position		
	FRONT Passenger	REAR Outboard	REAR Center
0 : Up to 10 kg (0 - 9 months)	X	U	U
0+ : Up to 13 kg (0 - 2 years)	X	U	U
I : 9 kg to 18 kg (9 months - 4 years)	X	U	U
II & III : 15 kg to 36 kg (4 - 12 years)	X	U	U

U : Suitable for "universal" category restraints approved for use in this mass group

UF : Suitable for forward-facing "universal" category restraints approved for use in this mass group

X : Seat position not suitable for children in this mass group

AIR BAG – SUPPLEMENTAL RESTRAINT SYSTEM

■ Left-hand drive

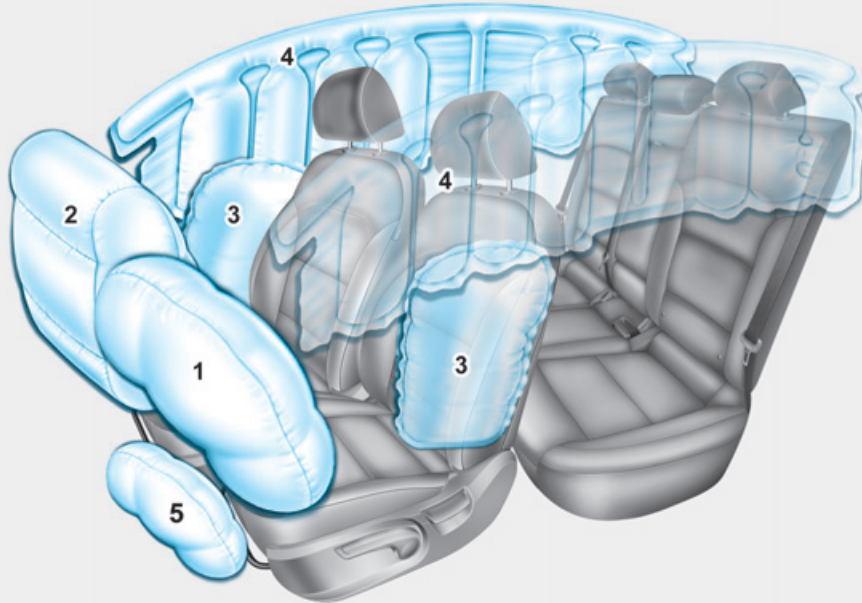

1. Driver's front air bag*
2. Passenger's front air bag*
3. Side air bag*
4. Curtain air bag*
5. Driver's knee air bag *

* : if equipped

The actual air bags in the vehicle may differ from the illustration.

OAD035033L

■ Right-hand drive

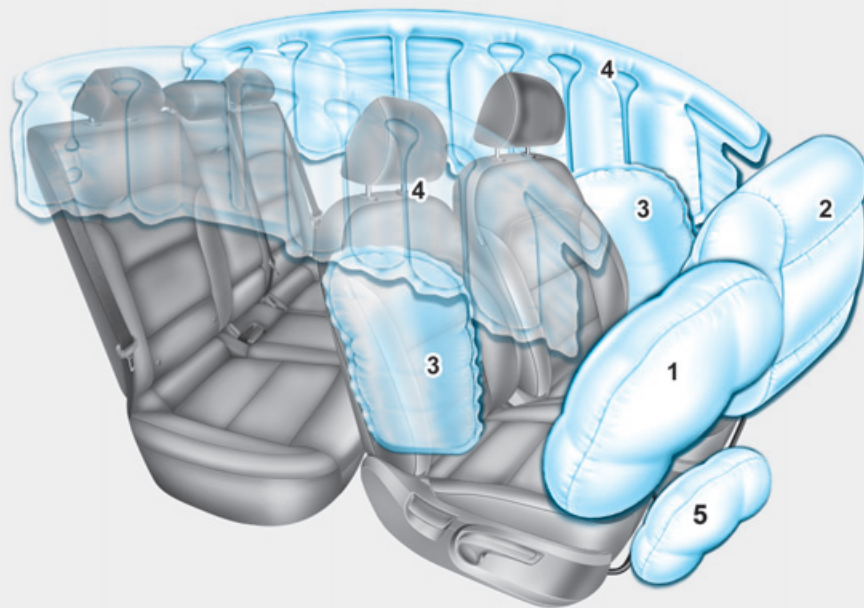

- 1. Driver's front air bag*
- 2. Passenger's front air bag*
- 3. Side air bag*
- 4. Curtain air bag*
- 5. Driver's knee air bag *

* : if equipped

The actual air bags in the vehicle may differ from the illustration.

OAD035033R

Vehicles are equipped with a Supplemental Air Bag System for the driver's seat and front passenger's seats.

The front air bags are designed to supplement the three-point seat belts. For these air bags to provide protection, the seat belts must be worn at all times when driving.

You can be severely injured or killed in an accident if you are not wearing a seat belt. Air bags are designed to supplement seat belts, but do not replace them. Also, air bags are not designed to deploy in every collision. In some accidents, the seat belts are the only restraint protecting you.

WARNING

AIR BAG SAFETY PRECAUTIONS

ALWAYS use seat belts and child restraints - every trip, every time, everyone! Even with air bags, you can be seriously injured or killed in a collision if you are improperly belted or not wearing your seat belt when the air bag inflates.

NEVER place a child in any child restraint or booster seat in the front passenger seat. An inflating air bag could forcefully strike the infant or child causing serious or fatal injuries.

ABC - Always Buckle Children under age 13 in the back seat. It is the safest place for children of any age to ride. If a child age 13 or older must be seated in the front seat, he or she must be properly belted and the seat should be moved as far back as possible.

All occupants should sit upright with the seatback in an upright position, centered on the seat cushion with their seat belt on, legs comfortably extended and their feet on the floor until the vehicle is parked and the engine is turned off. If an occupant is out of position during an accident, the rapidly deploying air bag may forcefully contact the occupant causing serious or fatal injuries.

You and your passengers should never sit or lean unnecessarily close to the air bags or lean against the door or center console.

Move your seat as far back as possible from front air bags, while still maintaining control of the vehicle.

Where are the air bags?

Driver's and passenger's air bags (if equipped)

■ Driver's front air bag



■ Passenger's front air bag



■ Driver's knee air bag

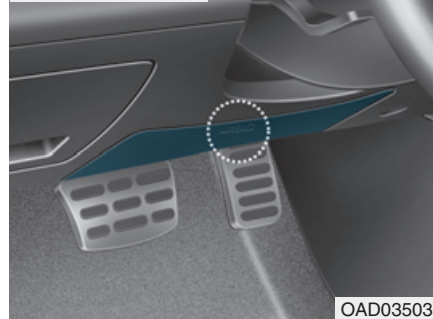

Your vehicle is equipped with a Supplemental Restraint System (SRS) and lap/shoulder belts at both the driver and passenger seating positions.

The SRS consists of air bags which are located in the center of the steering wheel and the passenger's side front panel pad above the glove box.

The air bags are labeled with the letters "AIR BAG" embossed on the pad covers.

The purpose of the SRS is to provide the vehicle's driver and front passengers with additional protection than that offered by the seat belt system alone in case of a frontal impact of sufficient severity.

⚠ WARNING

To reduce the risk of serious injury or death from an inflating front air bags, take the following precautions:

- Seat belts must be worn at all times to help keep occupants positioned properly.
- Move your seat as far back as possible from front air bags, while still maintaining control of the vehicle.
- Never lean against the door or center console.
- Do not allow the front passenger to place their feet or legs on the dashboard.
- No objects should be placed over or near the air bag modules on the steering wheel, instrument panel, and the front passenger's panel above the glove box. Such objects could cause harm if the vehicle is in a crash severe enough to cause the air bags to deploy.

Side air bags (if equipped)

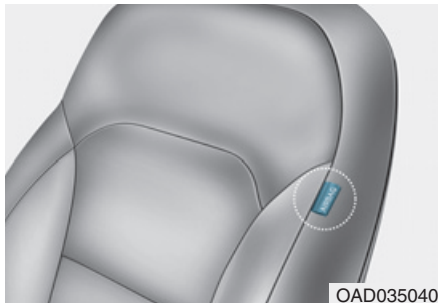

OAD035040

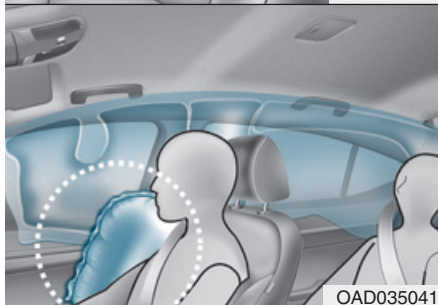

OAD035041

Your vehicle is equipped with a side air bag in each front seat. The purpose of the air bag is to provide the vehicle's driver and the front passenger with additional protection than that offered by the seat belt alone.

The side air bags are designed to deploy only during certain side impact collisions, depending on the crash severity, angle, speed and point of impact.

The side air bags are not designed to deploy in all side impact situations.

WARNING

To reduce the risk of serious injury or death from an inflating side air bag, take the following precautions:

- Seat belts must be worn at all times to help keep occupants positioned properly.
- Do not allow passengers to lean their heads or bodies onto doors, put their arms on the doors, stretch their arms out of the window, or place objects between the doors and seats.
- Hold the steering wheel at the 9 o'clock and 3 o'clock positions, to minimize the risk of injuries to your hands and arms.

(Continued)

(Continued)

- Do not use any accessory seat covers. This could reduce or prevent the effectiveness of the system.
- Do not place any objects over the air bag or between the air bag and yourself.
- Do not place any objects between the door and the seat. They may become dangerous projectiles if the side air bag inflates.
- Do not install any accessories on the side or near the side air bags.
- Do not cause impact to the doors when the ignition switch is in the ON position or this may cause the side air bags to inflate.
- If the seat or seat cover is damaged, we recommend that the system be serviced by an authorized HYUNDAI dealer.

Curtain air bags (if equipped)

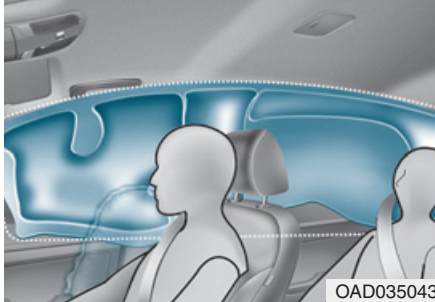

Curtain air bags are located along both sides of the roof rails above the front and rear doors.

They are designed to help protect the heads of the front seat occupants and the rear outboard seat occupants in certain side impact collisions.

The curtain air bags are designed to deploy only during certain side impact collisions, depending on the crash severity, angle, speed and impact.

The curtain air bags are not designed to deploy in all side impact situations.

⚠ WARNING

To reduce the risk of serious injury or death from an inflating curtain air bags, take the following precautions:

- **All seat occupants must wear seat belts at all times to help keep occupants positioned properly.**
- **Properly secure child restraints as far away from the door as possible.**
- **Do not allow passengers to lean their heads or bodies onto doors, put their arms on the doors, stretch their arms out of the window, or place objects between the doors and seats.**
- **Do not open or repair the side curtain air bags.**

How does the air bags system operate?

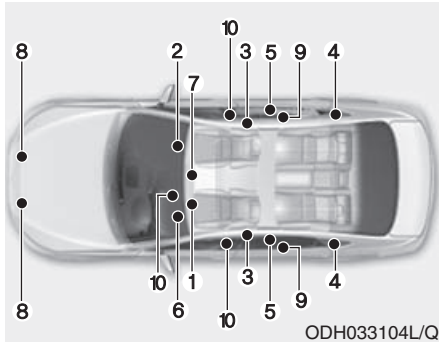

The SRS consists of the following components:

- (1) Driver's front air bag module
- (2) Passenger's front air bag module
- (3) Side air bag modules
- (4) Curtain air bag modules
- (5) Retractor pre-tensioner assemblies
- (6) Air bag warning light
- (7) SRS control module (SRSCM)/ Rollover sensor

- (8) Front impact sensors
- (9) Side impact sensors
- (10) Side Pressure sensors

The SRSCM continually monitors SRS components while the ignition switch is in the ON position to determine if a crash impact is severe enough to require air bag deployment or pre-tensioner seat belt deployment.



SRS warning light

The SRS air bag warning light on the instrument panel will illuminate for about 6 seconds after the ignition switch is turned to the ON position, after which the air bag warning light should go out.

WARNING

If your SRS malfunctions, the air bag may not inflate properly during an accident increasing the risk of serious injury or death.

If any of the following conditions occur, your SRS is malfunctioning:

- **The light does not turn on for approximately six seconds when the ignition switch is in the ON position.**

(Continued)

(Continued)

- **The light stays on after illuminating for approximately six seconds.**
- **The light comes on while the vehicle is in motion.**
- **The light blinks when the engine is running.**

We recommend that an authorized HYUNDAI dealer inspect the SRS as soon as possible if any of these conditions occur.

During a frontal collision, sensors will detect the vehicle's deceleration. If the rate of deceleration is high enough, the control unit will inflate the front air bags, at the time and with the force needed.

The front air bags help protect the driver and front passenger by responding to frontal impacts in which seat belts alone cannot provide adequate restraint. When needed, the side air bags help provide protection in the event of a side impact.

- Air bags are activated (able to inflate if necessary) only when the ignition switch is in the ON position.
- Air bags inflate in the event of certain frontal or side collisions to help protect the occupants from serious physical injury.
- Generally, air bags are designed to inflate based upon the severity of a collision it's direction etc. These two factors determine whether the sensors produce an electronic deployment/inflation signal.

- Air bag deployment depends on a number of factors including vehicle speed, angles of impact and the density and stiffness of the vehicles or objects which your vehicle impacts during a collision. The determining factors are not limited to those mentioned above.
- The front air bags will completely inflate and deflate in an instant. It is virtually impossible for you to see the air bags inflate during an accident. It is much more likely that you will simply see the deflated air bags hanging out of their storage compartments after the collision.

- To help provide protection, the air bags must inflate rapidly. The speed of air bag inflation is a consequence of extremely short time in which to inflate the air bag between the occupant and the vehicle structures before the occupant impacts those structures. This speed of inflation reduces the risk of serious or life-threatening injuries and is thus a necessary part of air bag design.

However, the rapid air bag inflation can also cause injuries which can include facial abrasions, bruises and broken bones because the inflation speed also causes the air bags to expand with a great deal of force.

- There are even circumstances under which contact with the air bag can cause fatal injuries, especially if the occupant is positioned excessively close to the air bag.

You can take steps to reduce the risk of being injured by an inflating air bag. The greatest risk is sitting too close to the air bag. An air bag needs space to inflate. It is recommended that drivers sit as far as possible between the center of the steering wheel and the chest while still maintaining control of the vehicle.



When the SRSCM detects a sufficiently severe impact to the front of the vehicle, it will automatically deploy the front air bags.

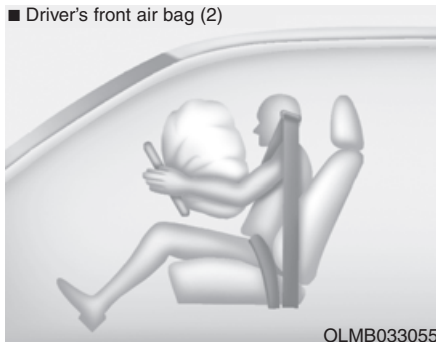

Upon deployment, tear seams molded directly into the pad covers will separate under pressure from the expansion of the air bags. Further opening of the covers allows full inflation of the air bags.

A fully inflated air bag, in combination with a properly worn seat belt, slows the driver's or the front passenger's forward motion, reducing the risk of head and chest injury.

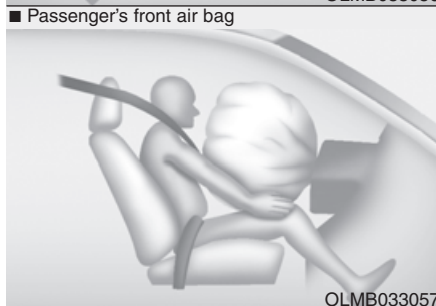
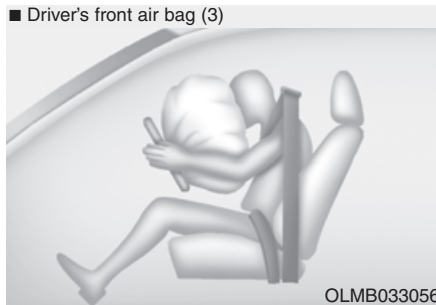

After complete inflation, the air bag immediately starts deflating, enabling the driver to maintain forward visibility and the ability to steer or operate other controls.

⚠ WARNING

To prevent objects from becoming dangerous projectiles when the passenger's air bag inflates:

- Do not install or place any objects (drink holder, CD holder, stickers, etc.) on the front passenger's panel above the glove box where the passenger's air bag is located.
- Do not install a container of liquid air freshener near the instrument cluster or on the instrument panel surface.

What to expect after an air bag inflates

After a frontal or side air bag inflates, it will deflate very quickly. Air bag inflation will not prevent the driver from seeing out of the windshield or being able to steer. Curtain air bags may remain partially inflated for some time after they deploy.

WARNING

After an air bag inflates, take the following precautions:

- **Open your windows and doors as soon as possible after impact to reduce prolonged exposure to the smoke and powder released by the inflating air bag.**
- **Do not touch the air bag storage area's internal components immediately after an air bag has inflated. The parts that come into contact with an inflating air bag may be very hot.**

(Continued)

(Continued)

- **Always wash exposed skin areas thoroughly with luke-warm water and mild soap.**
- **We recommend that an authorized HYUNDAI dealer replace the air bag immediately after deployment. Air bags are designed to be used only once.**

Noise and smoke from inflating air bag

When the air bags inflate, they make a loud noise and may produce smoke and powder in the air inside of the vehicle. This is normal and is a result of the ignition of the air bag inflator. After the air bag inflates, you may feel substantial discomfort in breathing because of the contact of your chest with both the seat belt and the air bag, as well as from breathing the smoke and powder. The powder may aggravate asthma for some people. If you experience breathing problems after an air bag deployment, seek medical attention immediately.

Though the smoke and powder are nontoxic, they may cause irritation to the skin, eyes, nose, throat, etc. If this is the case, wash and rinse with cold water immediately and seek medical attention if the symptoms persist.

Do not install a child restraint on the front passenger seat

■ Type A



OYDESA2042

■ Type B

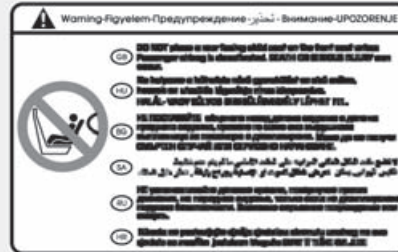

OLM034310

Never install a child restraint in the front passenger's seat. An inflating air bag can forcefully strike a child or restraint resulting in serious or fatal injury.

⚠ WARNING

- **Extreme hazard! Do not use a rearward facing child restraint on a seat protected by an air bag in front of it!**
- **NEVER use a rearward facing child restraint on a seat protected by an ACTIVE AIRBAG in front of it, DEATH or SERIOUS INJURY to the CHILD can occur.**
- **Never put a child restraint in the front passenger's seat. If the front passenger air bag inflates, it would cause serious or fatal injuries.**

Why didn't my air bag go off in a collision?

Air bags are not designed to inflate in every collision.

There are certain types of accidents in which the air bag would not be expected to provide additional protection. These include rear impacts, second or third collisions in multiple impact accidents, as well as low speed impacts. Damage to the vehicle indicates a collision energy absorption, and is not an indicator of whether or not an air bag should have inflated.

Air bag collision sensors (if equipped)

WARNING

To reduce the risk of an air bag deploying unexpectedly and causing serious injury or death:

- **Do not hit or allow any objects to impact the locations where air bags or sensors are installed.**
- **Do not perform maintenance on or around the air bag sensors. If the location or angle of the sensors is altered, the air bags may deploy when they should not or may not deploy when they should.**
- **Do not install bumper guards or replace the bumper with a non-genuine part. This may adversely affect the collision and air bag deployment performance.**

(Continued)

(Continued)

- **Place the ignition switch to the LOCK/OFF or ACC position, when the vehicle is being towed to prevent inadvertent air bag deployment.**
- **We recommend that all air bag repairs are conducted by an authorized HYUNDAI dealer.**

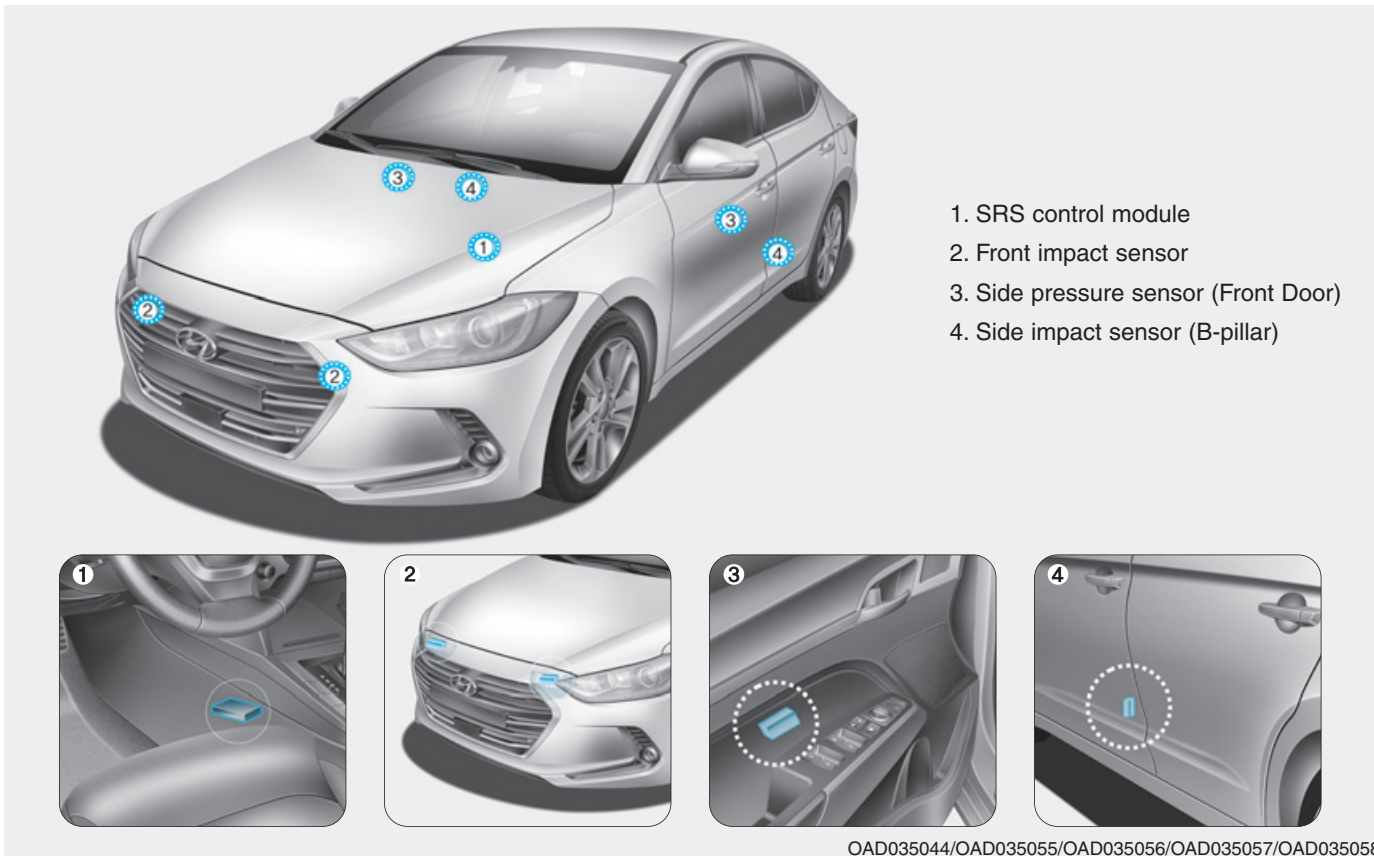

OAD035044/OAD035055/OAD035056/OAD035057/OAD035058

Air bag inflation conditions

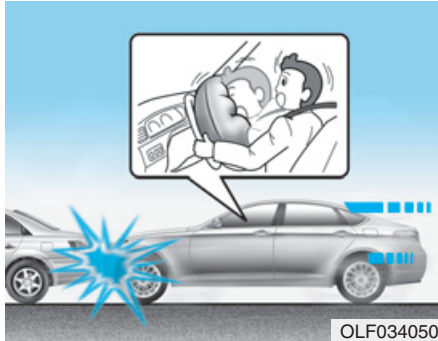

Front air bags

Front air bags are designed to inflate in a frontal collision depending on the severity of impact of the front collision.

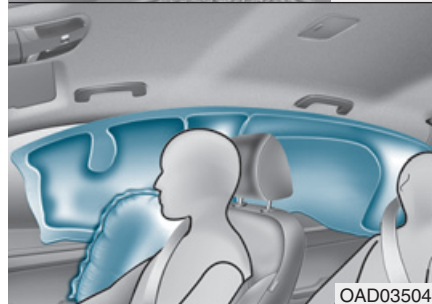

Side and curtain air bags

Side and curtain air bags are designed to inflate when an impact is detected by side collision sensors depending on the severity of impact resulting from a side impact collision.

Although the driver's and front passenger's air bags are designed to inflate only in frontal collisions, they also may inflate in other types of collisions if the front impact sensors detect a sufficient impact. Side and curtain air bags are designed to inflate only in side impact collisions, but they may inflate in other collisions if the side impact sensors detect a sufficient impact.

If the vehicle chassis is impacted by bumps or objects on unimproved roads, the air bags may deploy. Drive carefully on unimproved roads or on surfaces not designed for vehicle traffic to prevent unintended air bag deployment.

Air bag non-inflation conditions



In certain low-speed collisions the air bags may not deploy. The air bags are designed not to deploy in such cases because they may not provide benefits beyond the protection of the seat belts.

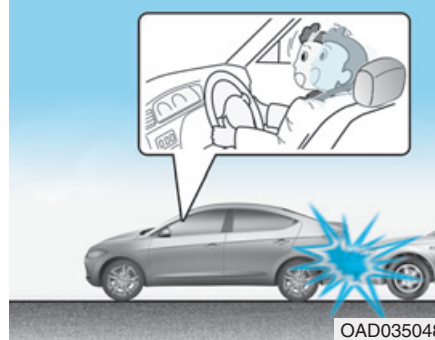

Front air bags are not designed to inflate in rear collisions, because occupants are moved backward by the force of the impact. In this case, inflated air bags would not provide any additional benefit.

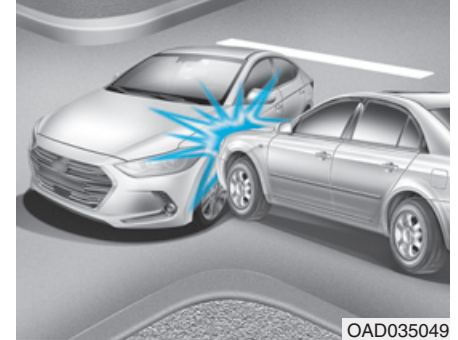

Front air bags may not inflate in side impact collisions, because occupants move in the direction of the collision, and thus in side impacts, front air bag deployment would not provide additional occupant protection.

However, side and curtain air bags may inflate depending on the severity of impact.

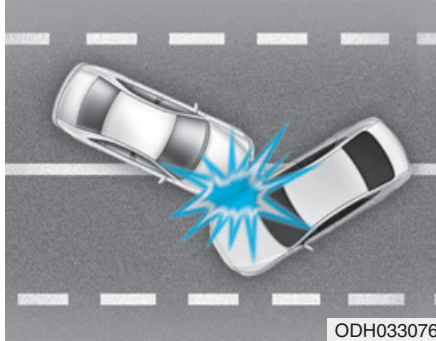

In an angled collision, the force of impact may direct the occupants in a direction where the air bags would not be able to provide any additional benefit, and thus the sensors may not deploy any air bags.

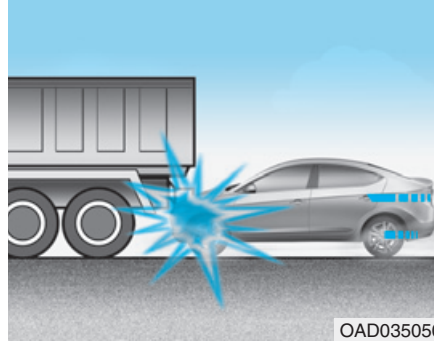

Just before impact, drivers often brake heavily. Such heavy braking lowers the front portion of the vehicle causing it to “ride” under a vehicle with a higher ground clearance. Air bags may not inflate in this “under-ride” situation because deceleration forces that are detected by sensors may be significantly reduced by such “override” collisions.

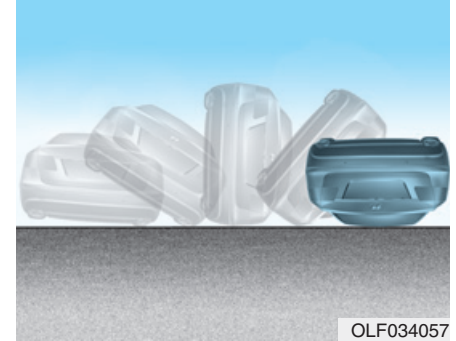

Front air bags may not inflate in rollover accidents because front air bag deployment would not provide additional occupant protection.

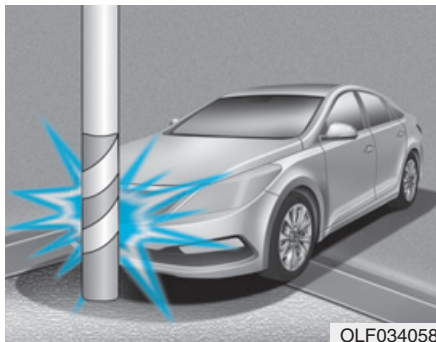

OLF034058

Air bags may not inflate if the vehicle collides with objects such as utility poles or trees, where the point of impact is concentrated and the collision energy is absorbed by the vehicle structure.

SRS care

The SRS is virtually maintenance-free and there are no parts you can safely service by yourself. If the SRS air bag warning light does not illuminate when the ignition switch is in the ON position, or continuously remains on, we recommend that the system be immediately inspected by an authorized HYUNDAI dealer.

We recommend any work on the SRS system, such as removing, installing, repairing, or any work on the steering wheel, the front passenger's panel, front seats and roof rails be performed by an authorized HYUNDAI dealer. Improper handling of the SRS system may result in serious personal injury.

WARNING

To reduce the risk of serious injury or death take the following precautions:

- **Do not attempt to modify or disconnect the SRS components or wiring, including the addition of any kind of badges to the pad covers or modifications to the body structure.**
- **Do not place objects over or near the air bag modules on the steering wheel, instrument panel, and the front passenger's panel above the glove box.**
- **Clean the air bag pad covers with a soft cloth moistened with plain water. Solvents or cleaners could adversely affect the air bag covers and proper deployment of the system.**
- **We recommend that inflated air bags be replaced by an authorized HYUNDAI dealer.**

(Continued)

(Continued)

- **If components of the air bag system must be discarded, or if the vehicle must be scrapped, certain safety precautions must be observed. Consult an authorized HYUNDAI dealer for the necessary information. Failure to follow these precautions could increase the risk of personal injury.**

Additional safety precautions

Passengers should not move out of or change seats while the vehicle is moving. A passenger who is not wearing a seat belt during a crash or emergency stop can be thrown against the inside of the vehicle, against other occupants, or be ejected from the vehicle.

Do not use any accessories on seat belts. Devices claiming to improve occupant comfort or reposition the seat belt can reduce the protection provided by the seat belt and increase the chance of serious injury in a crash

Do not modify the front seats. Modification of the front seats could interfere with the operation of the supplemental restraint system sensing components or side air bags.

Do not place items under the front seats. Placing items under the front seats could interfere with the operation of the supplemental restraint system sensing components and wiring harnesses.

Do not cause impact to the doors. Impact to the doors when the ignition switch is in the ON position may cause the air bags to inflate.

Adding equipment to or modifying your air bag equipped vehicle

If you modify your vehicle by changing your vehicle's frame, bumper system, front end or side sheet metal or ride height, this may affect the operation of your vehicle's air bag system.

Air bag warning labels (if equipped)

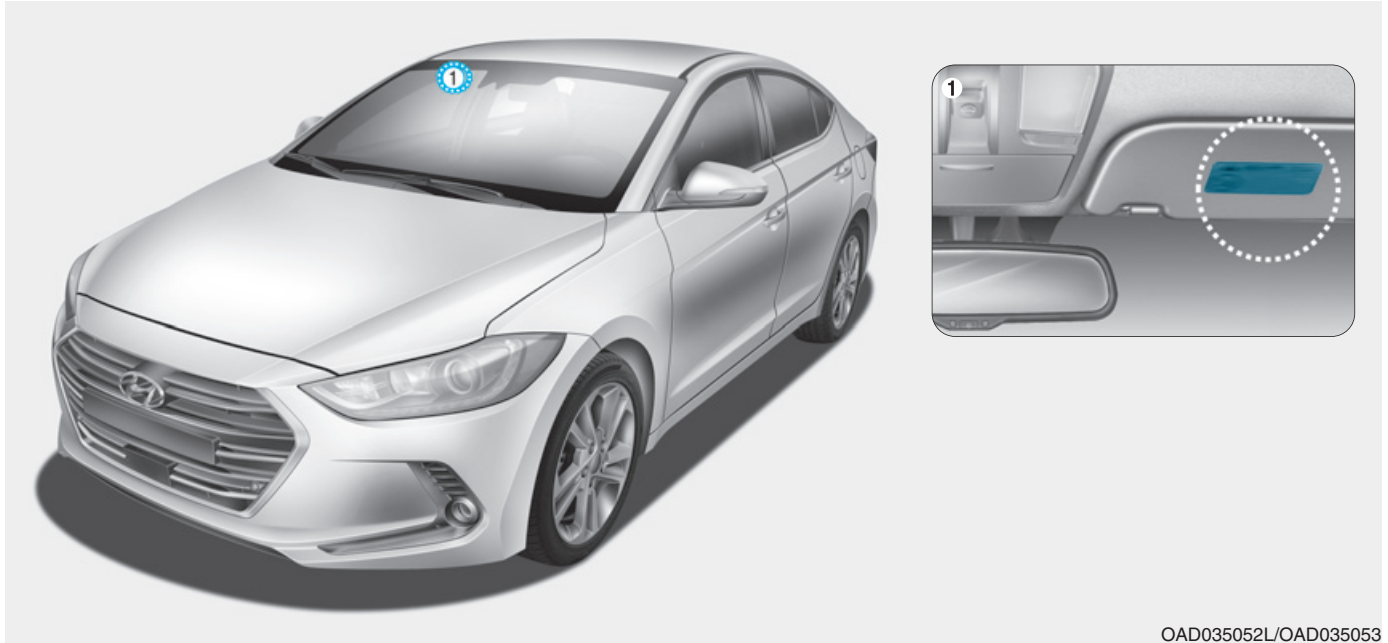

Air bag warning labels are attached to alert the driver and passengers of potential risks of the air bag system. Be sure to read all of the information about the air bags that are installed on your vehicle in this Owner's Manual.

Convenient features of your vehicle

Accessing your vehicle	3-4	Windows	3-31
Remote key	3-4	Power windows	3-31
Smart key	3-8	Sunroof	3-37
Immobilizer system	3-13	Sunroof opening and closing	3-37
Door locks	3-14	Sliding the sunroof	3-37
Operating door locks from outside the vehicle	3-14	Tilting the sunroof	3-38
Operating door locks from inside the vehicle	3-16	Sunshade	3-39
Auto door lock/unlock features	3-18	Resetting the sunroof	3-40
Child-protector rear door locks	3-19	Exterior features	3-41
Theft-alarm system	3-20	Hood	3-41
Driver position memory system	3-21	Trunk	3-43
Storing memory positions	3-21	Smart trunk	3-44
Easy access function	3-22	Fuel filler door	3-48
Steering wheel	3-23	Instrument cluster	3-51
Electric power steering (EPS)	3-23	Instrument cluster control	3-53
Tilt steering / Telescope steering	3-24	Gauges	3-54
Heated steering wheel	3-25	Odometer	3-57
Horn	3-25	Warning and indicator lights	3-57
Mirrors	3-26	LCD display messages	3-71
Inside rearview mirror	3-26	LCD display (for supervision cluster)	3-82
Outside rearview mirror	3-27	LCD display control	3-82
		LCD modes	3-82
		User settings mode	3-86

Trip computer	3-90
Conventional cluster	3-90
Supervision cluster	3-94
Light	3-99
Exterior lights	3-99
Welcome system	3-106
Interior lights.....	3-107
Wipers and washers	3-110
Windshield wipers	3-110
Windshield washers.....	3-112
Driver assist system	3-114
Rear view camera	3-114
Rear parking assist system	3-115
Parking assist system	3-118
Defroster	3-122
Rear window defroster	3-122
Manual climate control system	3-123
Heating and air conditioning.....	3-124
System operation	3-129
System maintenance	3-132
Automatic climate control system	3-134
Automatic heating and air conditioning.....	3-135
Manual heating and air conditioning.....	3-136
System operation.....	3-143
System maintenance.....	3-146
Windshield defrosting and defogging	3-148
Manual climate control system	3-148
Automatic climate control system	3-149
Defogging logic.....	3-150
Auto defogging system	3-151
Climate control additional features	3-152
Cluster ionizer	3-152
Sunroof inside air recirculation.....	3-152
Storage compartment	3-153
Center console storage	3-153
Sliding armrest.....	3-153
Glove box	3-154
Sunglass holder	3-154
Multi box	3-155

Interior features	3-156
Ashtray	3-156
Cup holder.....	3-156
Sunvisor	3-157
Power outlet.....	3-158
USB charger	3-159
Cigarette lighter	3-159
Clock.....	3-160
Clothes hanger	3-160
Floor mat anchor(s).....	3-161
Luggage net (holder)	3-161

ACCESSING YOUR VEHICLE

Remote key



Your HYUNDAI uses a remote key, which you can use to lock or unlock a door (and trunk) and even start the engine.

1. Door Lock
2. Door Unlock
3. Trunk Unlock

Locking

To lock :

1. Close all doors, engine hood and trunk.
2. Press the Door Lock button (1) on the remote key.
3. The doors will lock. The hazard warning lights will blink. Also, the outside rearview mirror will fold, if the outside rearview mirror folding switch is in the AUTO position (if equipped).
4. Make sure the doors are locked by checking the position of the door lock button inside the vehicle.

WARNING

Do not leave the keys in your vehicle with unsupervised children. Unattended children could place the key in the ignition switch and may operate power windows or other controls, or even make the vehicle move, which could result in serious injury or death.

Unlocking

To unlock:

1. Press the Door Unlock button (2) on the remote key.
2. The doors will unlock. The hazard warning lights will blink two times. Also, the outside rearview mirror will unfold, if the outside rearview mirror folding switch is in the AUTO position (if equipped).

Information

After unlocking the doors, the doors will lock automatically after 30 seconds unless a door is opened.

Trunk unlocking

To unlock:

1. Press the Trunk Unlock button (3) on the remote key for more than one second.
2. The hazard warning lights will blink two times. Once the trunk is opened and then closed, the trunk will lock automatically.

i Information

- After unlocking the trunk, the trunk will lock automatically.
- The word "HOLD" is written on the button to inform you that you must press and hold the button for more than one second.

Start-up

For detailed information refer to "Key Ignition Switch" in chapter 5.

NOTICE

To prevent damaging the remote key:

- **Keep the remote key away from water or any liquid and fire. If the inside of the remote key gets damp (due to drinks or moisture), or is heated, internal circuit may malfunction, excluding the car from the warranty.**
- **Avoid dropping or throwing the remote key.**
- **Protect the remote key from extreme temperatures.**

Mechanical key



If the remote key does not operate normally, you can lock or unlock the door by using the mechanical key.

To unfold the key, press the release button then the key will unfold automatically.

To fold the key, fold the key manually while pressing the release button.

NOTICE

Do not fold the key without pressing the release button. This may damage the key.

Remote key precautions

The remote key will not work if any of the following occur:

- The key is in the ignition switch.
- You exceed the operating distance limit (about 30 m [90 feet]).
- The remote key battery is weak.
- Other vehicles or objects may be blocking the signal.
- The weather is extremely cold.
- The remote key is close to a radio transmitter such as a radio station or an airport which can interfere with normal operation of the remote key.

When the remote key does not work correctly, open and close the door with the mechanical key. If you have a problem with the remote key, it is recommended that you contact an authorized HYUNDAI dealer.

(Continue)

(Continue)

If the remote key is in close proximity to your mobile phone, the signal could be blocked by your mobile phones normal operational signals. This is especially important when the phone is active such as making and receiving calls, text messaging, and/or sending/receiving emails. Avoid placing the remote key and your mobile phone in the same pants or jacket pocket and always try to maintain an adequate distance between the two devices.

i Information

Changes or modifications not expressly approved by the party responsible for compliance could void the user's authority to operate the equipment. If the keyless entry system is inoperative due to changes or modifications not expressly approved by the party responsible for compliance, it will not be covered by your manufacturer's vehicle warranty.

NOTICE

Keep the remote key away from electromagnetic materials that blocks electromagnetic waves to the key surface.

Battery replacement

If the remote key is not working properly, try replacing the battery with a new one.

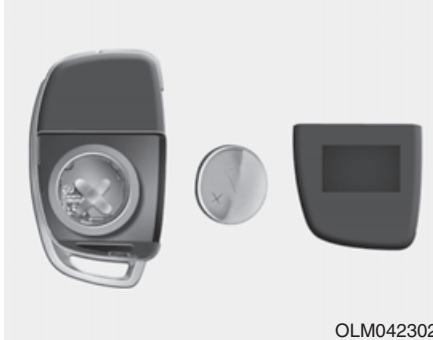

Battery Type: CR2032

To replace the battery:

1. Insert a slim tool into the slot and gently pry open the cover.
2. Remove the old battery and insert the new battery. Make sure the battery position is correct.
3. Reinstall the rear cover of the remote key.

If you suspect your remote key might have sustained some damage, or you feel your remote key is not working correctly, it is recommended that you contact an authorized HYUNDAI dealer.

i Information



An inappropriately disposed battery can be harmful to the environment and human health. Dispose the battery according to your local law(s) and regulation.

Smart key



OBA043222IN

Your HYUNDAI uses a Smart Key, which you can use to lock or unlock a door (and trunk) and even start the engine.

1. Door Lock
2. Door Unlock
3. Trunk Unlock

Locking

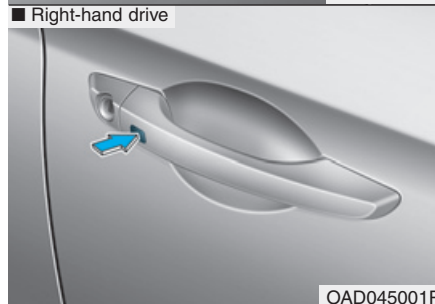
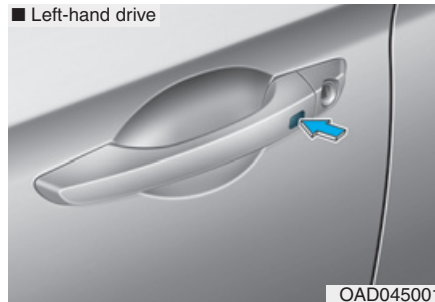

To lock :

1. Close all doors, engine hood and trunk.
2. Either press the door handle button or press the Door Lock button (1) on the smart key.
3. The hazard warning lights will blink. Also, the outside rearview mirror will fold, if the outside rearview mirror folding switch is in the AUTO position (if equipped).
4. Make sure the doors are locked by checking the position of the door lock button inside the vehicle.

i Information

The door handle button will only operate when the smart key is within 0.7~1 m (28~40 in.) from the outside door handle.

Even though you press the outside door handle button, the doors will not lock and the chime will sound for three seconds if any of the following occur:

- The Smart Key is in the vehicle.
- The Engine Start/Stop button is in ACC or ON position.
- Any door except the trunk is open.

WARNING

Do not leave the Smart Key in your vehicle with unsupervised children. Unattended children could press the Engine Start/Stop button and may operate power windows or other controls, or even make the vehicle move, which could result in serious injury or death.

Unlocking

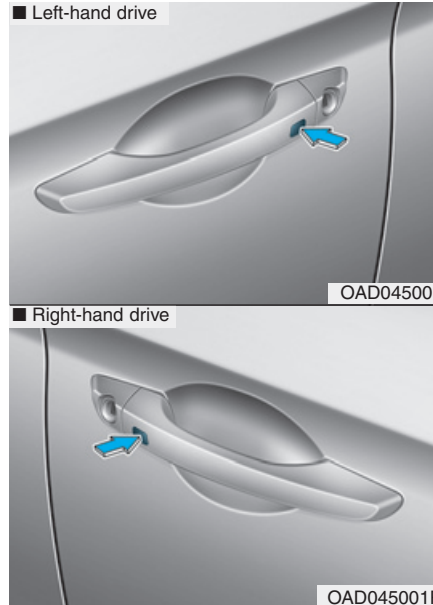

To unlock:

1. Carry the Smart Key.
2. Either press the door handle button or press the Door Unlock button (2) on the smart key.

3. The doors will unlock. The hazard warning lights will blink two times. Also, the outside rearview mirror will unfold, if the outside rearview mirror folding switch is in the AUTO position. (if equipped)

Information

- The door handle button will only operate when the smart key is within 0.7~1 m (28~40 in.) from the outside door handle. Other people can also open the doors without the smart key in possession.
- After unlocking the doors, the doors will lock automatically after 30 seconds unless a door is opened.

Trunk unlocking

To unlock:

1. Carry the smart key.
2. Either press the trunk handle button or press the Trunk Unlock button (3) on the smart key for more than one second.
3. The hazard warning lights will blink two times.

Once the trunk is opened and then closed, the trunk will lock automatically.

i Information

After unlocking the trunk, the trunk will lock automatically after 30 seconds unless the trunk is opened.

Start-up

You can start the engine without inserting the key. **For detailed information refer to the Engine Start/Stop button in chapter 5.**

NOTICE

To prevent damaging the smart key:

- **Keep the smart key away from water or any liquid and fire. If the inside of the smart key gets damp (due to drinks or moisture), or is heated, internal circuit may malfunction, excluding the car from the warranty.**
- **Avoid dropping or throwing the smart key.**
- **Protect the smart key from extreme temperatures.**

Mechanical key

If the Smart Key does not operate normally, you can lock or unlock the door by using the mechanical key.



Press and hold the release button (1) and remove the mechanical key (2). Insert the mechanical key into the key hole on the door.

To reinstall the mechanical key, put the key into the hole and push it until a click sound is heard.

Loss of a smart key

A maximum of two smart keys can be registered to a single vehicle. If you happen to lose your smart key, it is recommended that you should immediately take the vehicle and remaining key to your authorized HYUNDAI dealer or tow the vehicle, if necessary.

Smart key precautions

The smart key will not work if any of the following occur:

- The smart key is close to a radio transmitter such as a radio station or an airport which can interfere with normal operation of the transmitter.
- The smart key is near a mobile two way radio system or a cellular phone.
- Another vehicle's smart key is being operated close to your vehicle.

When the smart key does not work correctly, open and close the door with the mechanical key. If you have a problem with the smart key, it is recommended that you contact an authorized HYUNDAI dealer.

If the smart key is in close proximity to your mobile phone, the signal could be blocked by your mobile phones normal operational signals. This is especially important when the phone is active such as making and receiving calls, text messaging, and/or sending/receiving emails. Avoid placing the smart key and your mobile phone in the same pants or jacket pocket and always try to maintain an adequate distance between the two devices.

i Information

Changes or modifications not expressly approved by the party responsible for compliance could void the user's authority to operate the equipment. If the keyless entry system is inoperative due to changes or modifications not expressly approved by the party responsible for compliance, it will not be covered by your manufacturer's vehicle warranty.

NOTICE

Keep the smart key away from electromagnetic materials that blocks electromagnetic waves to the key surface.

Battery replacement

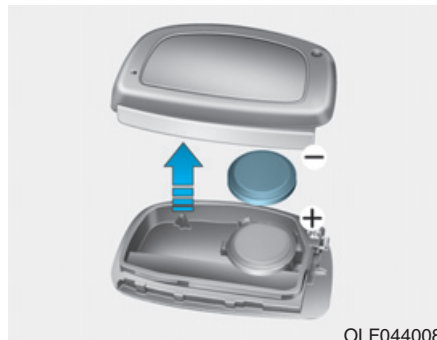

If the Smart Key is not working properly, try replacing the battery with a new one.

Battery Type: CR2032

To replace the battery:

1. Pry open the rear cover of the smart key.
2. Remove the old battery and insert the new battery. Make sure the battery position is correct.
3. Reinstall the rear cover of the smart key.

If you suspect your smart key might have sustained some damage, or you feel your smart key is not working correctly, it is recommended that you contact an authorized HYUNDAI dealer.

i Information



An inappropriately disposed battery can be harmful to the environment and human health. Dispose the battery according to your local law(s) and regulation.

Immobilizer system (if equipped)

The immobilizer system protects your vehicle from theft. If an improperly coded key (or other device) is used, the engine's fuel system is disabled.

When the ignition switch is placed in the ON position, the immobilizer system indicator should come on briefly, then go off. If the indicator starts to blink, the system does not recognize the coding of the key.

Place the ignition switch to the LOCK/OFF position, then place the ignition switch to the ON position again.

The system may not recognize your key's coding if another immobilizer key or other metal object (i.e., key chain) is near the key. The engine may not start because the metal may interrupt the transponder signal from transmitting normally.

If the system repeatedly does not recognize the coding of the key, it is recommended that you contact your HYUNDAI dealer.

Do not attempt to alter this system or add other devices to it. Electrical problems could result that may make your vehicle inoperable.

WARNING

In order to prevent theft of your vehicle, do not leave spare keys anywhere in your vehicle. Your immobilizer password is a customer unique password and should be kept confidential.

NOTICE

The transponder in your key is an important part of the immobilizer system. It is designed to give years of trouble-free service, however you should avoid exposure to moisture, static electricity and rough handling. Immobilizer system malfunction could occur.

DOOR LOCKS

Operating door locks from outside the vehicle

Mechanical key

■ Left-hand drive

• Type A



• Type B



OAD045002

■ Right-hand drive

• Type A



• Type B



OAD045002R

Turn the key toward the rear of the vehicle to unlock and toward the front of the vehicle to lock.

If you lock/unlock the driver's door with a key, all vehicle doors will lock/unlock automatically. (if equipped with the central door lock system)

Once the doors are unlocked, they may be opened by pulling the door handle.

When closing the door, push the door by hand. Make sure that doors are closed securely.

Remote key



OHG040006L

To lock the doors, press the Door Lock button (1) on the remote key.

To unlock the doors, press the Door Unlock button (2) on the remote key.

Once the doors are unlocked, they may be opened by pulling the door handle.

When closing the door, push the door by hand. Make sure that doors are closed securely.

i Information

- In cold and wet climates, door lock and door mechanisms may not work properly due to freezing conditions.
- If the door is locked/unlocked multiple times in rapid succession with either the vehicle key or door lock switch, the system may stop operating temporarily in order to protect the circuit and prevent damage to system components.

Smart key

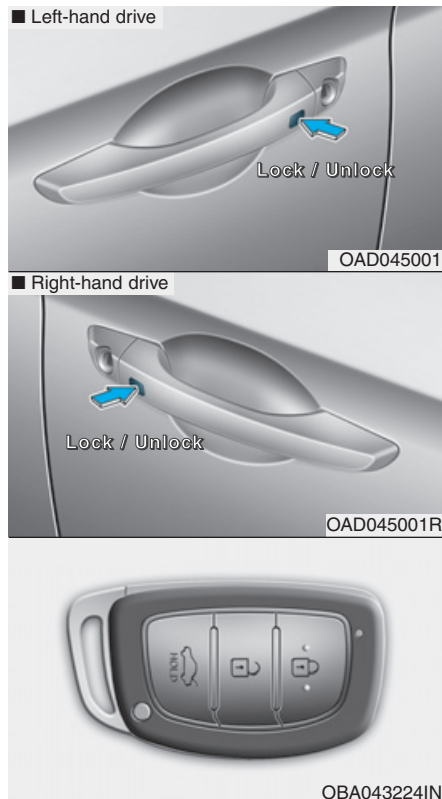

To lock the doors, press the button on the outside door handle while carrying the smart key with you or press the door lock button on the smart key.

To unlock the doors, press the button on the outside door handle while carrying the smart key with you or press the door unlock button on the smart key.

Once the doors are unlocked, they may be opened by pulling the door handle.

When closing the door, push the door by hand. Make sure that doors are closed securely.

i Information

- In cold and wet climates, door lock and door mechanisms may not work properly due to freezing conditions.
- If the door is locked/unlocked multiple times in rapid succession with either the vehicle key or door lock switch, the system may stop operating temporarily in order to protect the circuit and prevent damage to system components.

Operating door locks from inside the vehicle

With the door lock button

■ Left-hand drive

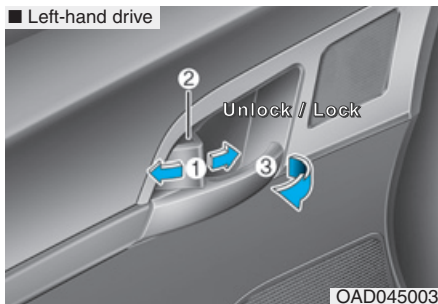

■ Right-hand drive

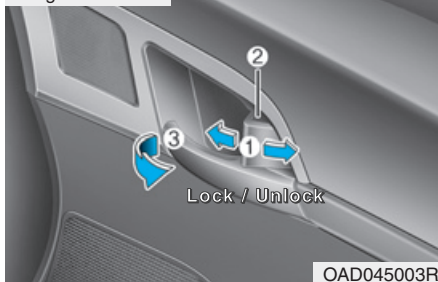

- To unlock a door, pull the door lock button (1) to the “Unlock” position. The red mark (2) on the door lock button will be visible.
- To lock a door, push the door lock button (1) to the “Lock” position. If the door is locked properly, the red mark (2) on the door lock button will not be visible.
- To open a door, pull the door handle (3) outward.
- If the inner door handle of the driver’s (or front passenger’s) door is pulled when the door lock button is in the lock position, the button is unlocked and door opens.
- Front doors cannot be locked if the key is in the ignition switch and any front door is open.
- Doors cannot be locked if the smart key is in the vehicle and any door is open.

i Information

If a power door lock ever fails to function while you are in the vehicle try one or more of the following techniques to exit:

Operate the door unlock feature repeatedly (both electronic and manual) while simultaneously pulling on the door handle.

Operate the other door locks and handles, front and rear.

Lower a front window and use the mechanical key to unlock the door from outside.

With the central door lock switch



When pressing the (1) portion of the switch, all vehicle doors will lock.

- If the key is in the ignition switch and any door is opened, the doors will not lock even though the lock button (1) of the central door lock switch is pressed.
- If the smart key is in the vehicle and any door is opened, the doors will not lock even though the lock button (1) of the central door lock switch is pressed.

When pressing the (2) portion of the switch, all vehicle doors will unlock.

WARNING

The doors should always be fully closed and locked while the vehicle is in motion. If the doors are unlocked, the risk of being thrown from the vehicle in a crash is increased.

WARNING

Do not leave children or animals unattended in your vehicle. An enclosed vehicle can become extremely hot, causing death or serious injury to unattended children or animals who cannot escape the vehicle. Children might operate features of the vehicle that could injure them, or they could encounter other harm, possibly from someone gaining entry to the vehicle.

⚠ WARNING

Always secure your vehicle

Leaving your vehicle unlocked increases the potential risk to you or others from someone hiding in your vehicle.

To secure your vehicle, while depressing the brake, move the shift lever to the P (Park) position (for automatic transmission/dual clutch transmission) or first gear or R (Reverse, for manual transmission), engage the parking brake, and place the ignition switch in the LOCK/OFF position, close all windows, lock all doors, and always take the key with you.

⚠ WARNING

Opening a door when something is approaching may cause damage or injury. Be careful when opening doors and watch for vehicles, motorcycles, bicycles or pedestrians approaching the vehicle in the path of the door.

Auto door lock/unlock features

Impact sensing door unlock system (if equipped)

All doors will be automatically unlocked when an impact causes the air bags to deploy.

Speed sensing door lock system (if equipped)

All doors will be automatically locked when vehicle speed exceeds 15 km/h (9 mph).

You can activate or deactivate the Auto Door Lock/Unlock features from the User Settings Mode on the LCD display. **For more details, refer to "LCD Display" in this chapter.**

Child-protector rear door locks

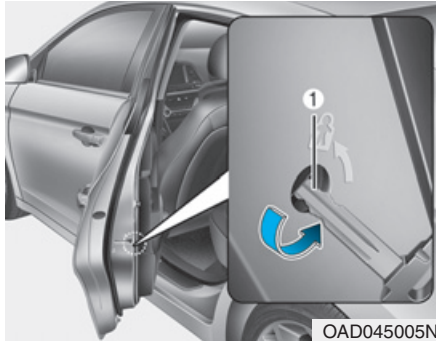

The child safety lock is provided to help prevent children seated in the rear from accidentally opening the rear doors. The rear door safety locks should be used whenever children are in the vehicle.

The child safety lock is located on the edge of each rear door. When the child safety lock is in the lock position, the rear door will not open if the inner door handle is pulled.

To lock the child safety lock, insert a key (or screwdriver) (1) into the hole and turn it to the lock position.

To allow a rear door to be opened from inside the vehicle, unlock the child safety lock.

WARNING

If children accidentally open the rear doors while the vehicle is in motion, they could fall out of the vehicle. The rear door safety locks should always be used whenever children are in the vehicle.

THEFT-ALARM SYSTEM

This system helps to protect your vehicle and valuables. The horn will sound and the hazard warning lights will blink continuously if any of the following occurs:

- A door is opened without using the remote key or smart key.
- The trunk is opened without using the remote key or smart key.
- The engine hood is opened.

The alarm continues for 30 seconds, then the system resets. To turn off the alarm, unlock the doors with the remote key or smart key.

The Theft Alarm System automatically sets 30 seconds after you lock the doors and the trunk. For the system to activate, you must lock the doors and the trunk from outside the vehicle with the remote key or smart key or by pressing the button on the outside of the door handles with the smart key in your possession.

The hazard warning lights will blink and the chime will sound once to indicate the system is armed.

Once the security system is set, opening any door, the trunk, or the hood without using the remote key or smart key will cause the alarm to activate.

The Theft Alarm System will not set if the hood, the trunk, or any door is not fully closed. If the system will not set, check the hood, the trunk, or the doors are fully closed.

Do not attempt to alter this system or add other devices to it.

i Information

- **Do not lock the doors until all passengers have left the vehicle. If the remaining passenger leaves the vehicle when the system is armed, the alarm will be activated.**
- **If the vehicle is not disarmed with the remote key or smart key, open the doors by using the mechanical key and place the ignition switch in the ON position (for remote key) or start the engine (for smart key) and wait for 30 seconds.**
- **When the system is disarmed but a door or trunk is not opened within 30 seconds, the system will be rearmed.**



OJC040170

i Information

Vehicles equipped with a theft alarm system will have a label attached to the vehicle with the following words:

1. WARNING
2. SECURITY SYSTEM

DRIVER POSITION MEMORY SYSTEM (IF EQUIPPED)

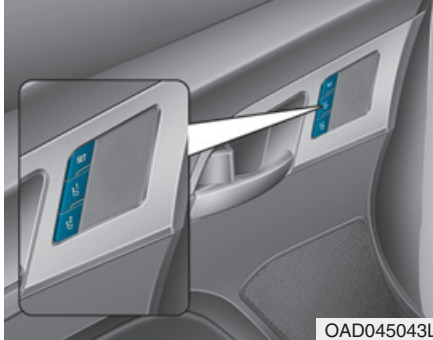

The Driver Position Memory System is provided to store and recall the following memory settings with a simple button operation.

- Driver's seat position
- Outside rearview mirror position
- Instrument panel illumination intensity

⚠ WARNING

Never attempt to operate the driver position memory system while the vehicle is moving.

This could result in loss of control, and an accident causing death, serious injury, or property damage.

i Information

- **If the battery is disconnected, the memory settings will be erased.**
- **If the Driver Position Memory System does not operate normally, we recommend that you have the system checked by an authorized HYUNDAI dealer.**

Storing memory positions

1. Move the shift lever into P (for automatic transmission/dual clutch transmission) or Neutral (for manual transmission) while the ignition switch or the Engine Start/Stop button is in the ON position.
2. Adjust the driver's seat position, outside rearview mirror position and instrument panel illumination intensity to the desired position.
3. Press the SET button. The system will beep once and notify you "Press button to save settings" on the LCD display.
4. Press one of the memory buttons (1 or 2) within 5 seconds. The system will beep twice when the memory has been successfully stored.



"Driver 1 (or 2) settings saved" will appear on the LCD display.

Recalling memory position

1. Move the shift lever into P (for automatic transmission/dual clutch transmission) or Neutral (for manual transmission) while the ignition switch or the Engine Start/Stop button is in the ON position.
2. Press the desired memory button (1 or 2). The system will beep once, then the driver's seat position, outside rearview mirror and instrument panel illumination will automatically adjust to the stored position (if equipped).

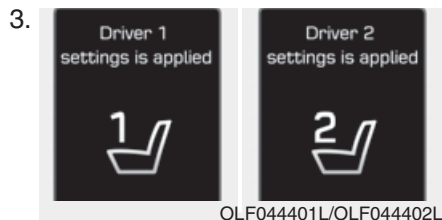

"Driver 1(or 2) settings is applied" will appear on the LCD display.

i Information

- While recalling the "1" memory position, pressing the SET or 1 button temporarily stops the adjustment of the recalled memory position. Pressing the 2 button recalls the "2" memory position.
- While recalling the "2" memory position, pressing the SET or 2 button temporarily stops the adjustment of the recalled memory position. Pressing the 1 button recalls the "1" memory position.
- While recalling the stored positions, pressing one of the control buttons for the driver's seat, outside rearview mirror, or instrument panel illumination will cause the movement of that component to stop and move in the direction that the control button is pressed.

Easy access function (if equipped)

The system will move the driver's seat automatically as follows:

The shift lever is in P or N (for automatic transmission/dual clutch transmission) or Neutral (for manual transmission).

- Without smart key system
 - It will move the driver's seat rearward when the ignition key is removed.
 - It will move the driver's seat forward when the ignition key is inserted.
- With smart key system
 - It will move the driver's seat rearward when the Engine Start/Stop button is changed to the OFF position.
 - It will move the driver's seat forward when the Engine Start/Stop button is changed to the ACC or START position.

You can activate or deactivate the Easy Access Function from the User Settings Mode on the LCD display.

For more details, refer to "LCD Display" in this chapter.

STEERING WHEEL

Electric power steering (EPS)

The system assists you with steering the vehicle. If the engine is off or if the power steering system becomes inoperative, the vehicle may still be steered, but it will require increased steering effort.

Also, the steering effort becomes heavier as the vehicle's speed increases and becomes lighter as the vehicle's speed decreases for better control of the steering wheel.

Should you notice any change in the effort required to steer during normal vehicle operation, we recommend that the system be checked by an authorized HYUNDAI dealer.

NOTICE

If the Electric Power Steering System does not operate normally, the warning light (⊖!) will illuminate on the instrument cluster. The steering wheel may become difficult to control or operate. Take your vehicle to an authorized HYUNDAI dealer and have the system checked as soon as possible.

i Information

The following symptoms may occur during normal vehicle operation:

- The steering effort may be high immediately after placing the ignition switch or the Engine Start/Stop button in the ON position.

This happens as the system performs the EPS system diagnostics. When the diagnostics is completed, the steering wheel will return to its normal condition.

(Continued)

(Continued)

- A click noise may be heard from the EPS relay after the ignition switch is placed to the ON or LOCK/OFF position (Without Smart key system).

A click noise may be heard from the EPS relay after the Engine Start/Stop button is in the ON or OFF position. (With Smart key system)

- Motor noise may be heard when the vehicle is at a stop or at a low driving speed.
- When you operate the steering wheel in low temperature, abnormal noise may occur. If temperature rises, the noise will disappear. This is a normal condition.
- When the vehicle is stationary, if you turn the steering wheel all the way to the left or right continuously, the steering wheel effort increases. This is not a system malfunction. As time passes, the steering wheel effort will return to its normal condition.

Tilt steering / Telescope steering

⚠ WARNING

Never adjust the steering wheel while driving. You may lose steering control and cause severe personal injury, death or accidents.

i Information

After adjustment, sometimes the lock-release lever may not lock the steering wheel.

It is not a malfunction. This occurs when two gears are not engaged correctly. In this case, adjust the steering wheel again and then lock the steering wheel.

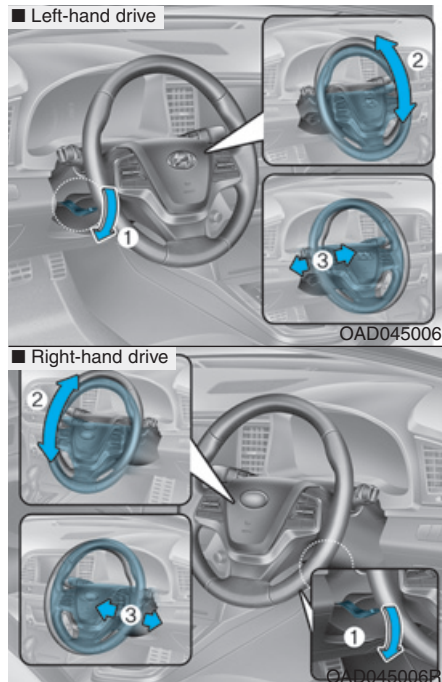

Pull down the lock-release lever (1) on the steering wheel column and adjust the steering wheel angle (2) and position (3, if equipped). Move the steering wheel, so it points toward your chest, not toward your face.

Make sure you can see the instrument panel warning lights and gauges.

After adjusting, pull up the lock-release lever (1) to lock the steering wheel in place. Push the steering wheel both up and down to be certain it is locked in position. Always adjust the position of the steering wheel before driving.

Heated steering wheel (if equipped)

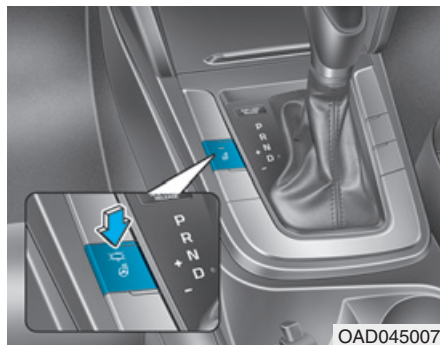

When the ignition switch is in the ON position or when the engine is running, press the heated steering wheel button to warm the steering wheel. The indicator on the button will illuminate.

To turn the heated steering wheel off, press the button again. The indicator on the button will turn off.

i Information

The heated steering wheel will turn off automatically approximately 30 minutes after the heated steering wheel is turned on.

When the engine is turned off during the engine and the heated steering wheel is on, the timer function of heated steering wheel will be reset.

To reuse heated steering wheel, press button again.

NOTICE

Do not install any cover or accessory on the steering wheel. This cover or accessory could cause damage to the heated steering wheel system.

Horn



To sound the horn, press the area indicated by the horn symbol on your steering wheel (see illustration). The horn will operate only when this area is pressed.

NOTICE

Do not strike the horn severely to operate it, or hit it with your fist. Do not press on the horn with a sharp-pointed object.

MIRRORS

Inside rearview mirror

Before you start driving, adjust the rearview mirror to the center on the view through the rear window.

⚠ WARNING

Make sure your line of sight is not obstructed. Do not place objects in the rear seat, cargo area, or behind the rear headrests which could interfere with your vision through the rear window.

⚠ WARNING

To prevent serious injury during an accident or deployment of the air bag, do not modify the rearview mirror and do not install a wide mirror.

⚠ WARNING

NEVER adjust the mirror while driving. This may cause loss of vehicle control resulting in an accident.

NOTICE

When cleaning the mirror, use a paper towel or similar material dampened with glass cleaner. Do not spray glass cleaner directly on the mirror as that may cause the liquid cleaner to enter the mirror housing.

Day/night rearview mirror (if equipped)

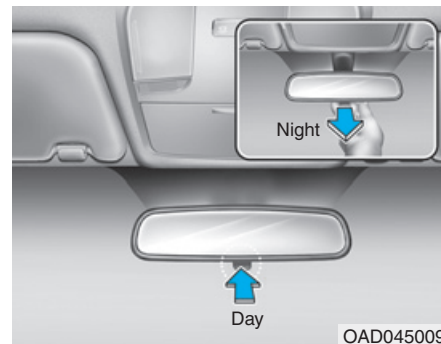

Make this adjustment before you start driving and while the day/night lever is in the day position.

Pull the day/night lever toward you to reduce glare from the headlights of the vehicles behind you during night driving.

Remember that you lose some rearview clarity in the night position.

Electric Chromic Mirror (ECM) (if equipped)

The electric rearview mirror automatically controls the glare from the headlamp of the car behind you in nighttime or low light driving conditions.

When the engine is running, the glare is automatically controlled by the sensor mounted in the rearview mirror. The sensor detects the light level around the vehicle, and automatically adjusts to control the headlamp glare from vehicles behind you.

Whenever the shift lever is placed in R (Reverse), the mirror will automatically go to the brightest setting in order to improve the drivers view behind the vehicle.

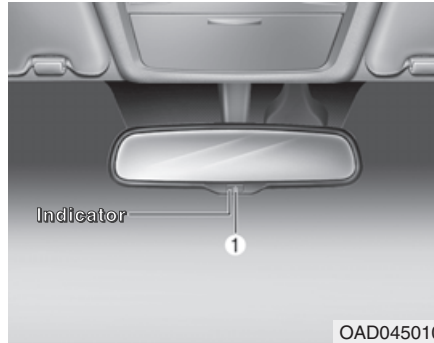

To operate the electric rearview mirror:

- Press the ON/OFF button (1) to turn the automatic dimming function off. The mirror indicator light will turn off.
- Press the ON/OFF button (1) to turn the automatic dimming function on. The mirror indicator light will illuminate.
- The mirror defaults to the ON position whenever the ignition switch or the Engine Start/Stop button is in the ON position.

Outside rearview mirror

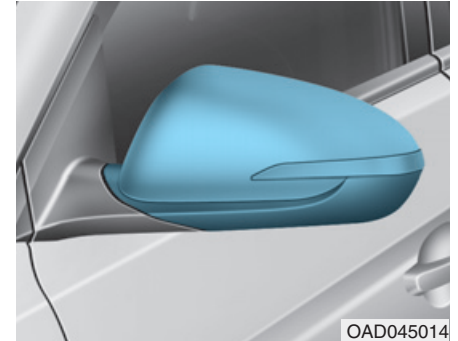

Be sure to adjust mirror angles before driving.

Your vehicle is equipped with both left-hand and right-hand outside rearview mirrors.

The mirror can be adjusted remotely with the remote switch.

The mirror heads can be folded to prevent damage during an automatic car wash or when passing through a narrow street.

⚠ WARNING

- The right outside rearview mirror is convex. In some countries, the left outside rearview mirror is also convex. Objects seen in the mirror are closer than they appear.
- Use your interior rearview mirror or turn your head and look to determine the actual distance of following vehicles when changing lanes.

⚠ WARNING

Do not adjust or fold the outside rearview mirrors while driving. This may cause loss of vehicle control resulting in an accident.

⚠ CAUTION

- Do not scrape ice off the mirror face; this may damage the surface of the glass.
- If the mirror is jammed with ice, do not adjust the mirror by force. Use an approved spray de-icer (not radiator antifreeze) spray, or a sponge or soft cloth with very warm water, or move the vehicle to a warm place and allow the ice to melt.

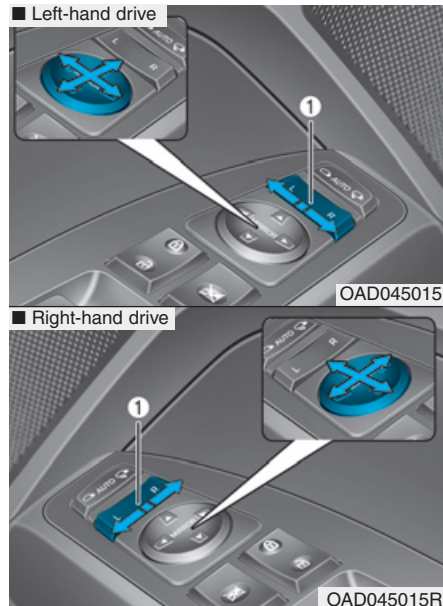

Adjusting the rearview mirrors:
Move the lever (1) to the L (Left) or R (Right) to select the rearview mirror you would like to adjust.
Use the mirror adjustment control to position the selected mirror up, down, left or right.

After adjustment, move the lever (1) to the middle to prevent inadvertent adjustment.

NOTICE

- The mirrors stop moving when they reach the maximum adjusting angles, but the motor continues to operate while the switch is pressed. Do not press the switch longer than necessary, the motor may be damaged.
- Do not attempt to adjust the outside rearview mirror by hand or the motor may be damaged.

Folding the outside rearview mirror

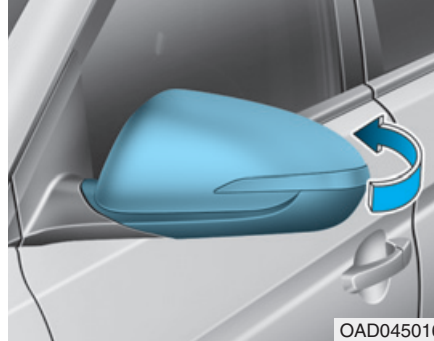

Manual type

To fold the outside rearview mirror, grasp the housing of the mirror and then fold it toward the rear of the vehicle.

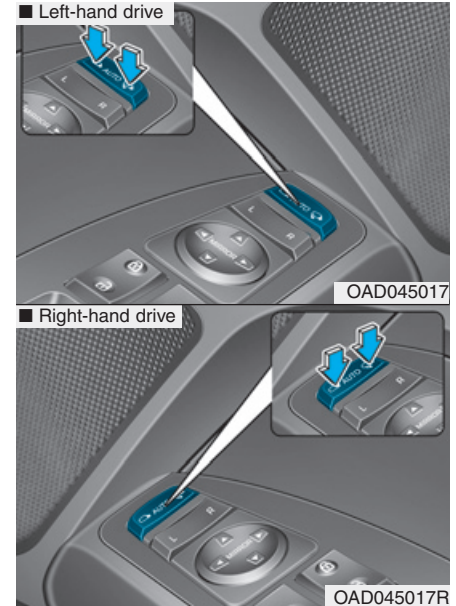

Electric type (if equipped)

Left : The mirror will unfold.

Right : The mirror will fold.

Center (AUTO) :

The mirror will fold or unfold automatically as follows:

- Without smart key system
 - The mirror will fold or unfold when the door is locked or unlocked by the transmitter.
- With smart key system
 - The mirror will fold or unfold when the door is locked or unlocked by the smart key.
 - The mirror will fold or unfold when the door is locked or unlocked by the button on the outside door handle.
 - The mirror will unfold when you approach the vehicle (all doors closed and locked) with a smart key in possession. (if equipped)

NOTICE

The electric type outside rearview mirror operates even though the ignition switch is in the OFF position. However, to prevent unnecessary battery discharge, do not adjust the mirrors longer than necessary while the engine is not running.

NOTICE

Do not fold the electric type outside rearview mirror by hand. It could cause motor failure.

WINDOWS

Power windows (if equipped)

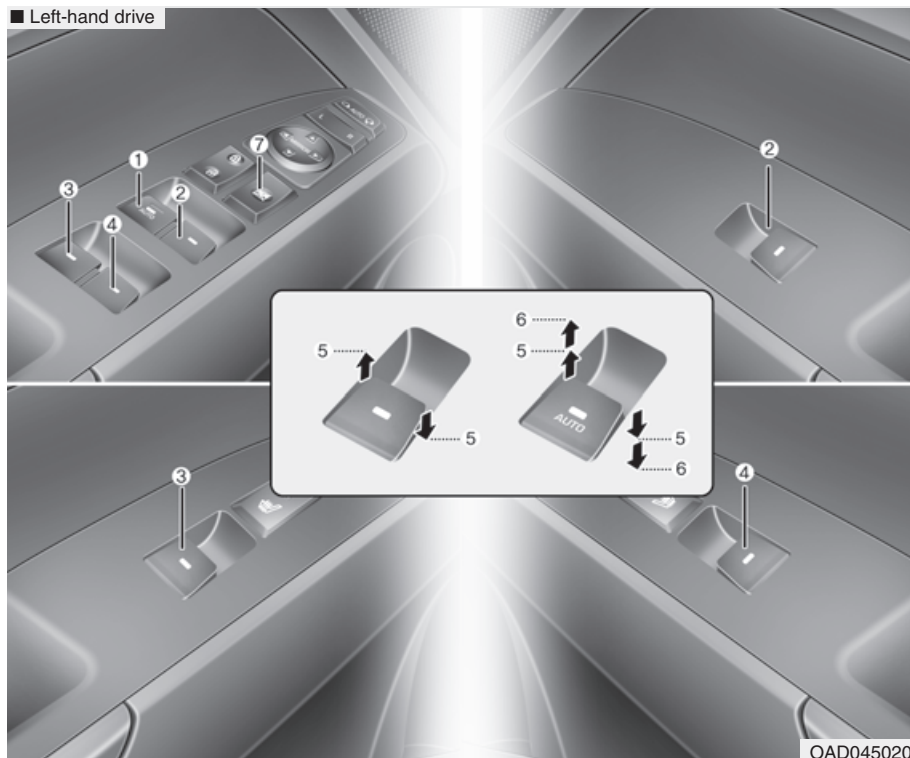

- (1) Driver's door power window switch
- (2) Front passenger's door power window switch
- (3) Rear door (left) power window switch
- (4) Rear door (right) power window switch
- (5) Window opening and closing
- (6) Automatic power window*
- (7) Power window lock switch

* : if equipped

■ Right-hand drive

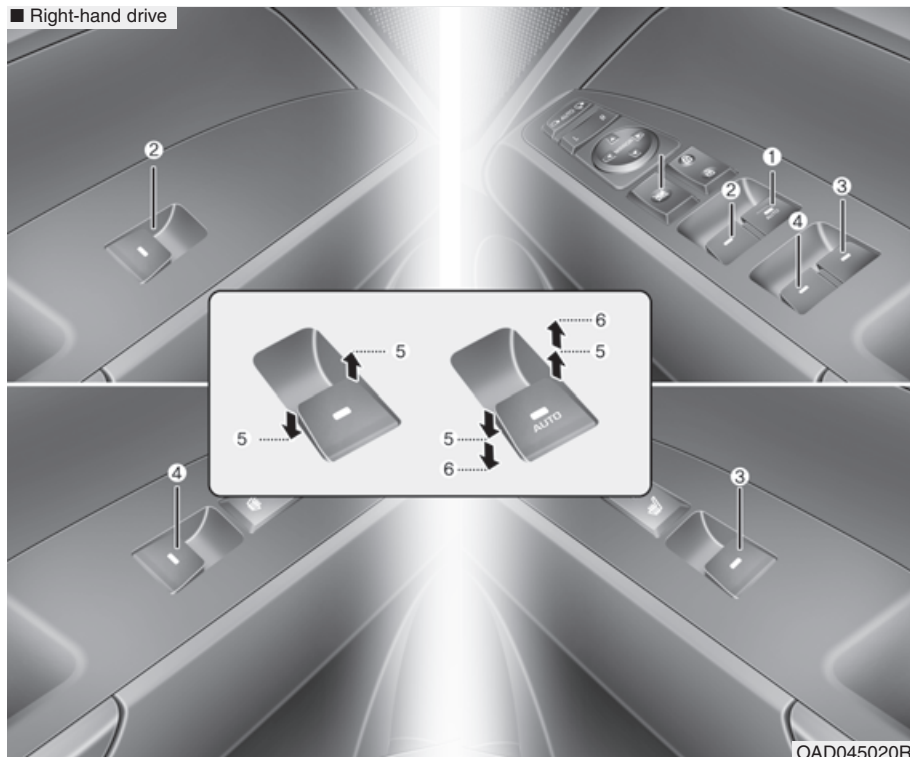

- (1) Driver's door power window switch
- (2) Front passenger's door power window switch
- (3) Rear door (right) power window switch
- (4) Rear door (left) power window switch
- (5) Window opening and closing
- (6) Automatic power window*
- (7) Power window lock switch

* : if equipped

The ignition switch must be in the ON position to be able to raise or lower the windows. Each door has a Power Window switch to control that door's window. The driver has a Power Window Lock switch which can block the operation of passenger windows. The power windows will operate for approximately 30 seconds after the ignition switch is placed in the ACC or OFF position. However, if the front doors are opened, the Power Windows cannot be operated even within the 30 second period.

⚠ WARNING

To avoid serious injury or death, do not extend your head, arms or body outside the windows while driving.

i Information

- **In cold and wet climates, power windows may not work properly due to freezing conditions.**
- **While driving with the rear windows down or with the sunroof (if equipped) opened (or partially opened), your vehicle may demonstrate a wind buffeting or pulsation noise. This noise is normal and can be reduced or eliminated by taking the following actions. If the noise occurs with one or both of the rear windows down, partially lower both front windows approximately one inch. If you experience the noise with the sunroof open, slightly close the sunroof.**

Window opening and closing

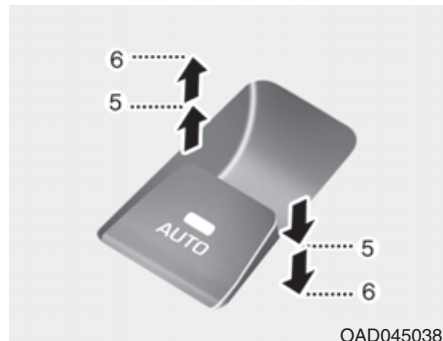

To open:

Press the window switch down to the first detent position (5). Release the switch when you want the window to stop.

To close:

Pull the window switch up to the first detent position (5). Release the window switch when you want the window to stop.

Auto down window (if equipped)

Pressing the power window switch momentarily to the second detent position (6) completely lowers the window even when the switch is released. To stop the window at the desired position while the window is in operation, pull up or press down and release the switch.

Auto up/down window (if equipped)

Pressing or pulling up the power window switch momentarily to the second detent position (6) completely lowers or lifts the window even when the switch is released. To stop the window at the desired position while the window is in operation, pull up or press down and release the switch.

To reset the power windows

If the power windows do not operate normally, the automatic power window system must be reset as follows:

1. Place the ignition switch to the ON position.
2. Close the window and continue pulling up on the power window switch for at least one second.

If the power windows do not operate properly after resetting, it is recommended that the system be checked by an authorized HYUNDAI dealer.

Automatic reversal (if equipped)

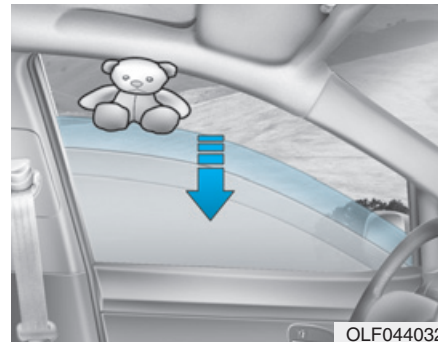

If a window senses any obstacle while it is closing automatically, it will stop and lower approximately 30 cm (12 inches) to allow the object to be cleared.

If the window detects the resistance while the power window switch is pulled up continuously, the window will stop upward movement then lower approximately 2.5 cm (1 inch).

If the power window switch is pulled up continuously again within 5 seconds after the window is lowered by the automatic window reversal feature, the automatic window reversal will not operate.

i Information

The automatic reverse feature is only active when the “Auto Up” feature is used by fully pulling up the switch to the second detent.

⚠ WARNING

Make sure body parts or other objects are safely out of the way before closing the windows to avoid injuries or vehicle damage.

Objects less than 4 mm (0.16 inch) in diameter caught between the window glass and the upper window channel may not be detected by the automatic reverse window and the window will not stop and reverse direction.

Power window lock switch

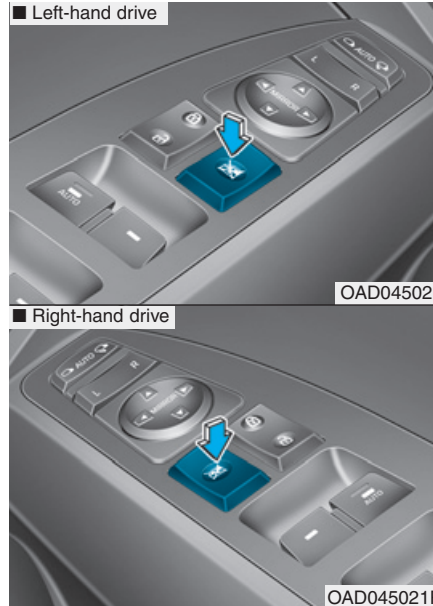

The driver can disable the power window switches on the rear passengers' doors by pressing the power window lock switch.

When the power window lock switch is pressed:

- The driver's master control can only operate the driver's power window.
- The front passenger's control can operate the front passenger's power window.
- The rear passenger's control cannot operate the rear passengers' power window.

⚠ WARNING

Do not allow children to play with the power windows. Keep the driver's door power window lock switch in the LOCK position. Serious injury or death can result from unintentional window operation by a child.

NOTICE

- To prevent possible damage to the power window system, do not open or close two windows or more at the same time. This will also ensure the longevity of the fuse.
- Never try to operate the main switch on the driver's door and the individual door window switch in opposite directions at the same time. If this is done, the window will stop and cannot be opened or closed.

⚠ WARNING

- **NEVER** leave the keys in your vehicle with unsupervised children, when the engine is running.
- **NEVER** leave any child unattended in the vehicle. Even very young children may inadvertently cause the vehicle to move, entangle themselves in the windows, or otherwise injure themselves or others.
- Always double check to make sure all arms, hands, head and other obstructions are safely out of the way before closing a window.
- Do not allow children to play with the power windows. Keep the driver's door power window lock switch in the LOCK position (pressed). Serious injury can result from unintentional window operation by the child.
- Do not extend your head, arms or body outside the windows while driving.

SUNROOF (IF EQUIPPED)



If your vehicle is equipped with a sunroof, you can slide or tilt your sunroof with the sunroof control switch located on the overhead console.

The sunroof can only be opened, closed, or tilted when the ignition switch is in the ON position.

Sunroof opening and closing



To open:

Press the sunroof control lever backward to the first detent position. Release the switch when you want the sunroof to stop.

To close:

Press the sunroof control lever backward to the first detent position. Release the switch when you want the sunroof to stop.

Sliding the sunroof

Pressing the sunroof control lever backward or forward momentarily to the second detent position completely opens or closes the sunroof even when the switch is released. To stop the sunroof at the desired position while the sunroof is in operation, press the sunroof control lever backward or forward and release the switch.

i Information

To reduce wind noise while driving, it is recommended that you drive with the sunroof slightly closed (stop the sunroof about 5 cm before the maximum slide open position).

NOTICE

To prevent damage to the sunroof and the motor, do not continue to press the sunroof control lever after the sunroof is in the fully open, closed or tilt position(s).

Automatic reversal



If the sunroof senses any obstacle while it is closing automatically, it will reverse direction then stop to allow the object to be cleared.

The auto reverse function does not work if a small obstacle is between the sliding glass and the sunroof sash.

You should always check that all passengers and objects are away from the sunroof before closing it.

Tilting the sunroof

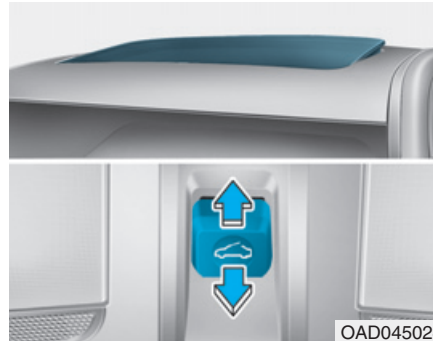

Tilt the sunroof open:

Push the sunroof control lever upward until the sunroof moves to the desired position.

To close the sunroof:

Press the sunroof lever forward until the sunroof moves to the desired position.

WARNING

- Make sure heads, other body parts or other objects are safely out of the way before closing the sunroof to avoid injuries or vehicle damage.
- Never adjust the sunroof or sunshade while driving. This may cause loss of vehicle control resulting in an accident.
- To avoid serious injury or death, do not extend your head, arms or body outside the sunroof while driving.

NOTICE

- Periodically remove any dirt that may accumulate on the sunroof guide rail or between the sunroof and roof panel, which can make a noise.
- Do not try to open the sunroof when the temperature is below freezing or when the sunroof is covered with snow or ice, the motor could be damaged. In cold and wet climates, the sunroof may not work properly.

***i* Information**

After washing the vehicle or after a rain, be sure to wipe off the water on the sunroof before operating the sunroof.

Sunshade

The sunshade will open automatically with the sunroof when the glass panel moves. If you want it closed, move the sunshade manually.

NOTICE

The sunroof is made to slide together with the sunshade. Do not leave the sunshade closed while the sunroof is open.

Resetting the sunroof

Sunroof needs to be reset if (in the followings)

- Battery is discharged or disconnected or the related fuse has been replaced or disconnected

- The one-touch sliding function of the sunroof does not normally operate

1. Place the ignition switch to the ON position or start the engine. It is recommended to reset the sunroof while the engine is running.

2. Push the control lever forward. The sunroof will close completely or tilt depending on the condition of the sunroof.

3. Release the control lever until the sunroof does not move.

4. Push the control lever forward about 10 seconds.

- When the sunroof is in the close position :

The glass will tilt and slightly move up and down.

- When the sunroof is in the tilt position:

The glass will slightly move up and down.

Do not release the lever until the operation is completed.

If you release the lever during operation, try again from step 2.

5. Within 3 seconds, push the control lever forward until the sunroof operates as follows:

Tilt down → Slide Open → Slide Close.

Do not release the lever until the operation is completed.

If you release the lever during operation, try again from step 2.

6. Release the sunroof control lever after all operation has completed. (The sunroof system has been reset.)

Information

- **If the sunroof does not reset when the vehicle battery is disconnected or discharged, or related fuse is blown, the sunroof may not operate normally.**
- **For more detailed information, we recommend that you contact an authorized HYUNDAI dealer.**

EXTERIOR FEATURES

Hood

Opening the hood

■ Left-hand drive

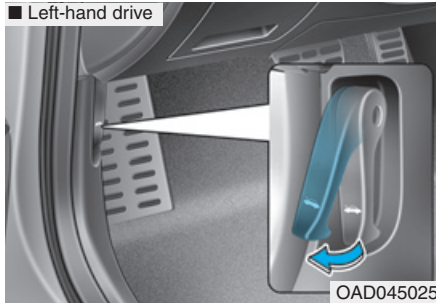

■ Right-hand drive

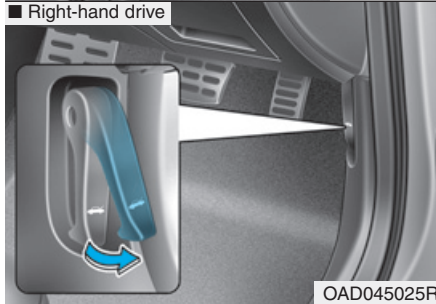

1. Park the vehicle and set the parking brake.
2. Pull the release lever to unlatch the hood. The hood should pop open slightly.

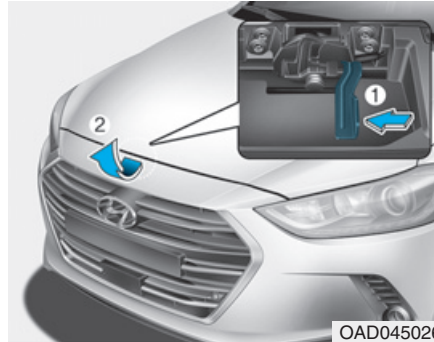

3. Go to the front of the vehicle, raise the hood slightly, push the secondary latch up (1) inside of the hood center and lift the hood (2).

4. Pull out the support rod.

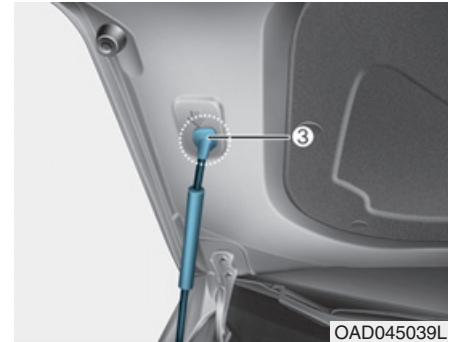

5. Hold the hood opened with the support rod (3).

 **WARNING**

Support rod

- Grasp the support rod in the area wrapped in rubber. The rubber will help prevent you from being burned by hot metal when the engine is hot.
- The support rod must be inserted completely into the hole provided whenever you inspect the engine compartment. This will prevent the hood from falling and possibly injuring you.

Closing the hood

1. Before closing the hood, check the following:
 - All filler caps in engine compartment must be correctly installed.
 - Gloves, rags or any other combustible material must be removed from the engine compartment.
2. Return the support rod to its clip to prevent it from rattling.
3. Lower the hood halfway and let it drop. Make sure that it locks into place.

 **WARNING**

- Before closing the hood, ensure all obstructions are removed from around hood opening.
- Always double check to be sure that the hood is firmly latched before driving away. If it is not latched, the hood could open while the vehicle is being driven, causing a total loss of visibility, which might result in an accident.
- Do not move the vehicle with the hood in the raised position, as vision is obstructed, which might result in an accident, and the hood could fall or be damaged.

Trunk

Opening the trunk

1. Make sure the shift lever is in P (Park, for automatic transmission) or first gear or R (Reverse, for manual transmission) and set the parking brake.

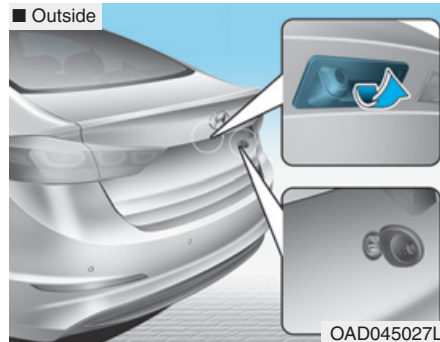

2. Then do one of the following :
 - Press the Remote key or Smart Key Trunk Unlock button for more than one second.
 - Press the button on the trunk itself with the Smart Key in your possession.
 - Use the mechanical key.

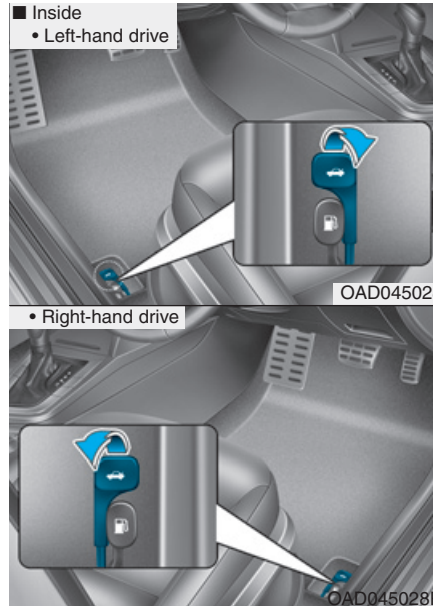

3. Lift the trunk lid up.
 - Use the trunk release lever.

Closing the trunk

Lower the trunk lid and press down until it locks. To be sure the trunk lid is securely fastened, always check by trying to pull it up again.

⚠ WARNING

Always keep the trunk lid completely closed while the vehicle is in motion. If it is left open or ajar, poisonous exhaust gases containing carbon monoxide (CO) may enter the vehicle and serious illness or death may result.

⚠ WARNING

Make sure there are no people or objects around the trunk before opening or closing the Power Trunk. Wait until the trunk is open fully and stopped before loading or unloading cargo from the vehicle.

i Information

To prevent damage to the trunk lift cylinders and the attached hardware, always close the trunk before driving.

NOTICE

In cold and wet climates, trunk lock and trunk mechanisms may not work properly due to freezing conditions.

⚠ WARNING

- **NEVER** allow anyone to occupy the trunk of the vehicle at any time. If the trunk is partially or totally latched and the person is unable to get out, serious injury or death could occur due to lack of ventilation, exhaust fumes and rapid heat build-up, or because of exposure to cold weather conditions. The trunk is also a highly dangerous location in the event of a crash because it is not a protected occupant space but is a part of the vehicle's crush zone.
- Your vehicle should be kept locked and keys should be kept out of the reach of children. Parents should teach their children about the dangers of playing in trunks.
- Use the release lever for emergencies only.

Smart trunk (if equipped)

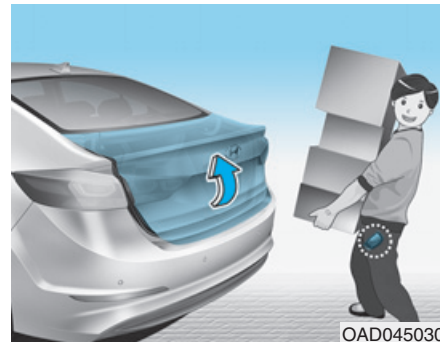

On a vehicle equipped with a smart key, the trunk can be opened using the Smart Trunk system.

How to use the Smart Trunk

The trunk can be opened with no-touch activation satisfying all the conditions below.

- After 15 seconds when all doors are closed and locked
- Positioned in the detecting area for more than 3 seconds.

i Information

- The Smart Trunk does not operate when:
 - The smart key is detected within 15 seconds after the doors are closed and locked, and is continuously detected.
 - The smart key is detected within 15 seconds after the doors are closed and locked, and 1.5 m from the front door handles. (for vehicles equipped with Welcome Light)
 - A door is not locked or closed.
 - The smart key is in the vehicle.

1. Setting

To activate the Smart Trunk, go to User Settings Mode and select Smart Trunk on the LCD display.

For more details, refer to "LCD Display" in this chapter.

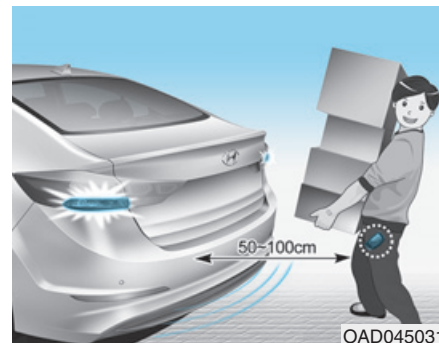

2. Detect and Alert

If you are positioned in the detecting area (50 ~100 cm behind the vehicle) carrying a smart key, the hazard warning lights will blink and chime will sound for about 3 seconds to alert you the smart key has been detected and the trunk will open.

i Information

Do not approach the detecting area if you do not want the trunk to open. If you have unintentionally entered the detecting area and the hazard warning lights and chime starts to operate, leave the detecting area with the smart key. The trunk will stay closed.

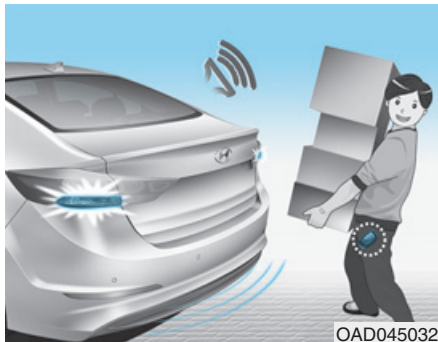

3. Automatic opening

The hazard warning lights will blink and chime will sound 2 times and then the trunk will slowly open.

⚠ WARNING

- Make sure you close the trunk before driving your vehicle.
- Make sure there are no people or objects around the trunk before opening or closing the trunk.
- Make sure objects in the trunk do not come out when opening the trunk on a slope. It may cause serious injury.
- Make sure to deactivate the Smart Trunk when washing your vehicle. Otherwise, the trunk may open inadvertently.
- The key should be kept out of reach of children. Children may inadvertently open the Smart Trunk while playing around the rear area of the vehicle.

How to deactivate the Smart Trunk function using the smart key



1. Door lock
2. Door unlock
3. Trunk open

If you press any button of the smart key during the Detect and Alert stage, the Smart Trunk function will be deactivated.

Make sure to be aware of how to deactivate the Smart Trunk function for emergency situations.

i Information

- If you press the door unlock button (2), the Smart Trunk function will be deactivated temporarily. But, if you do not open any door for 30 seconds, the smart trunk function will be activated again.
- If you press the trunk open button (3) for more than 1 second, the trunk opens.
- If you press the door lock button (1) or trunk open button (3) when the Smart Trunk function is not in the Detect and Alert stage, the smart trunk function will not be deactivated.
- In case you have deactivated the Smart Trunk function by pressing the smart key button and opened a door, the smart trunk function can be activated again by closing and locking all doors.

Detecting area

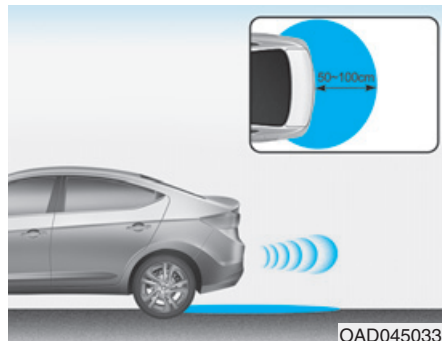

- The Smart Trunk operates with a welcome alert if the smart key is detected within 50~100 cm from the trunk.
- The alert stops at once if the smart key is positioned outside the detecting area during the Detect and Alert stage.

i Information

- The Smart Trunk function will not work if any of the following occurs:
 - The smart key is close to a radio transmitter such as a radio station or an airport which can interfere with normal operation of the transmitter.
 - The smart key is near a mobile two way radio system or a cellular phone.
 - Another vehicle's smart key is being operated close to your vehicle.
- The detecting range may decrease or increase when :
 - One side of the tire is raised to replace a tire or to inspect the vehicle.
 - The vehicle is slantingly parked on a slope or unpaved road, etc.

Fuel filler door

Opening the fuel filler door

■ Left-hand drive

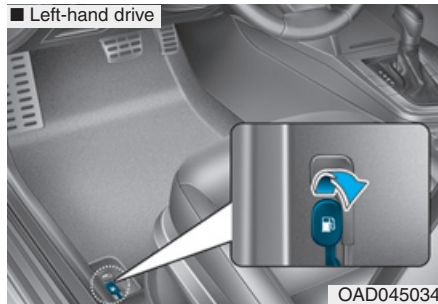

■ Right-hand drive

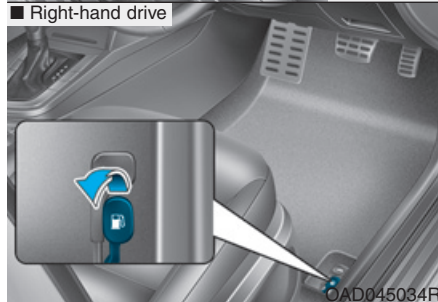

The fuel filler door must be opened from inside the vehicle by pulling up the fuel filler door opener.

1. Turn the engine off.
2. Push the fuel filler door opener button.

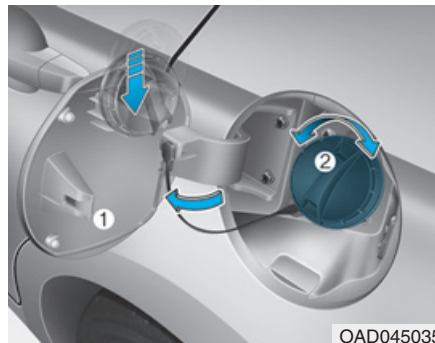

3. Pull the fuel filler door (1) out to fully open.
4. To remove the fuel tank cap (2), turn it counterclockwise. You may hear a hissing noise as the pressure inside the tank equalizes.
5. Place the cap on the fuel filler door.

⚠ WARNING

- **Your diesel vehicle is equipped with the specially-designed breakaway valve inside the filler inlet to prevent accidental fuel blending with gasoline.**

(Continued)

(Continued)

The fuel inlet of your diesel vehicle cannot be fitted with a standard gasoline nozzle.

Do not forcefully insert a standard gasoline nozzle into the filler inlet of your diesel vehicle. It may damage your vehicle.

- Some gas stations may still use standard gasoline nozzles for diesel refueling. If you find that a diesel nozzle is narrower than the fuel filler inlet diameter of your diesel vehicle, we recommend you to find/visit another gas station, which is equipped with standard diesel nozzles.
- Fully insert a standard diesel nozzle into the filler inlet to open the breakaway valve. If the nozzle is not fully inserted into the filler inlet, it causes diesel fuels to flow out of the fuel tank.

i Information

If the fuel filler door does not open because ice has formed around it, tap lightly or push on the door to break the ice and release the door. Do not pry on the door. If necessary, spray around the door with an approved de-icer fluid (do not use radiator anti-freeze) or move the vehicle to a warm place and allow the ice to melt.

Closing the fuel filler door

1. To install the fuel tank cap, turn it clockwise until it “clicks” one time.
2. Close the fuel filler door until it is latched securely.

⚠ WARNING

Gasoline is highly flammable and explosive. Failure to follow these guidelines may result in SERIOUS INJURY or DEATH:

- Read and follow all warnings posted at the gas station.
- Before refueling, note the location of the Emergency Gasoline Shut-Off, if available, at the gas station.
- Before touching the fuel nozzle, you should eliminate the potential build-up of static electricity by touching a metal part of the vehicle, a safe distance away from the fuel filler neck, nozzle, or other gas source, with your bare hand.

(Continued)

(Continued)

- Do not use cellular phones while refueling. Electric current and/or electronic interference from cellular phones can potentially ignite fuel vapors and cause a fire.
- Do not get back into a vehicle once you have begun refueling. You can generate a build-up of static electricity by touching, rubbing or sliding against any item or fabric capable of producing static electricity. Static electricity discharge can ignite fuel vapors causing a fire. If you must re-enter the vehicle, you should once again eliminate potentially dangerous static electricity discharge by touching a metal part of the vehicle, away from the fuel filler neck, nozzle or other gasoline source, with your bare hand.

(Continued)

(Continued)

- When refueling, always move the shift lever to the P (Park) position (for automatic transmission) or first gear or R (Reverse, for manual transmission), set the parking brake, and place the ignition switch to the LOCK/OFF position. Sparks produced by electrical components related to the engine can ignite fuel vapors causing a fire.
- When using an approved portable fuel container, be sure to place the container on the ground prior to refueling. Static electricity discharge from the container can ignite fuel vapors causing a fire. Once refueling has begun, contact between your bare hand and the vehicle should be maintained until the filling is complete.
- Use only approved portable plastic fuel containers designed to carry and store gasoline.

(Continued)

(Continued)

- Do not use matches or a lighter and do not smoke or leave a lit cigarette in your vehicle while at a gas station, especially during refueling.
- Do not over-fill or top-off your vehicle tank, which can cause gasoline spillage.
- If a fire breaks out during refueling, leave the vicinity of the vehicle, and immediately contact the manager of the gas station and then contact the local fire department. Follow any safety instructions they provide.
- If pressurized fuel sprays out, it can cover your clothes or skin and thus subject you to the risk of fire and burns. Always remove the fuel cap carefully and slowly. If the cap is venting fuel or if you hear a hissing sound, wait until the condition stops before completely removing the cap.

(Continued)

(Continued)

- Always check that the fuel cap is installed securely to prevent fuel spillage in the event of an accident.

i Information

Make sure to refuel your vehicle according to the "Fuel Requirements" suggested in the Introduction chapter.

NOTICE

- Do not spill fuel on the exterior surfaces of the vehicle. Any type of fuel spilled on painted surfaces may damage the paint.
- If the fuel filler cap requires replacement, use only a genuine HYUNDAI cap or the equivalent specified for your vehicle. An incorrect fuel filler cap can result in a serious malfunction of the fuel system or emission control system.

INSTRUMENT CLUSTER

■ Conventional cluster

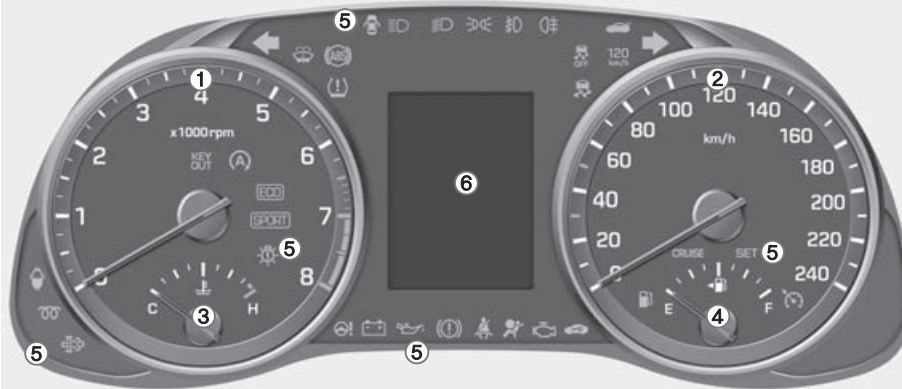

1. Tachometer
2. Speedometer
3. Engine coolant temperature gauge
4. Fuel gauge
5. Warning and indicator lights
6. LCD display (including Trip computer)

The actual cluster in the vehicle may differ from the illustration. For more details, refer to the "Gauges" in this chapter.

OAD045100L

■ Supervision cluster (Type A)



1. Tachometer
2. Speedometer
3. Engine coolant temperature gauge
4. Fuel gauge
5. Warning and indicator lights
6. LCD display (including Trip computer)

■ Supervision cluster (Type B)

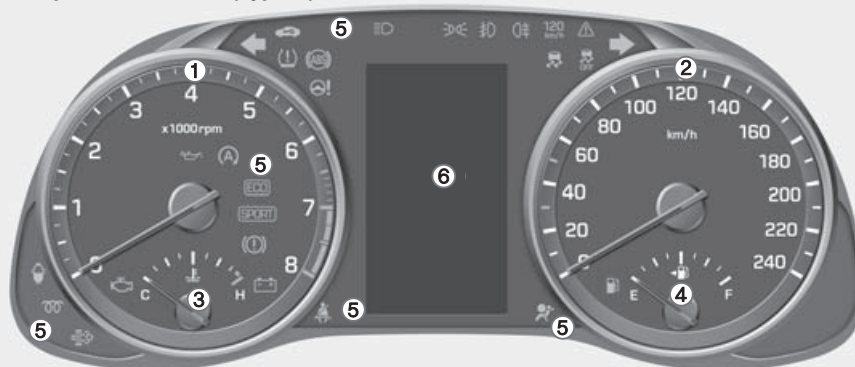

The actual cluster in the vehicle may differ from the illustration. For more details, refer to the "Gauges" in this chapter.

OAD045101L/OAD045102L

Instrument cluster control

Instrument panel illumination

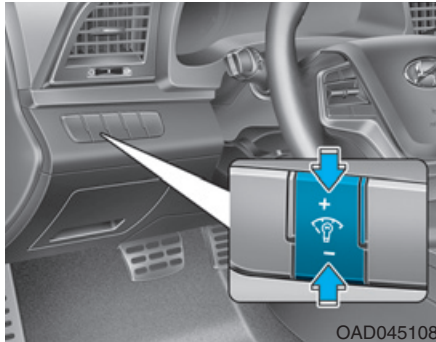

When the vehicle's parking lights or headlights are on, press the illumination control button to adjust the brightness of the instrument panel illumination.

When pressing the illumination control button, the interior switch illumination intensity is also adjusted.

⚠ WARNING

Never adjust the instrument cluster while driving. This could result in loss of control and lead to an accident that may cause death, serious injury, or property damage.

■ Conventional cluster

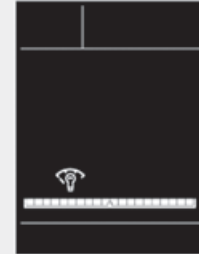

■ Supervision cluster (Type A)



■ Supervision cluster (Type B)

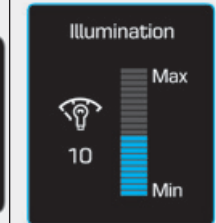

- The brightness of the instrument panel illumination is displayed.
- If the brightness reaches to the maximum or minimum level, a chime will sound.

Gauges

Speedometer

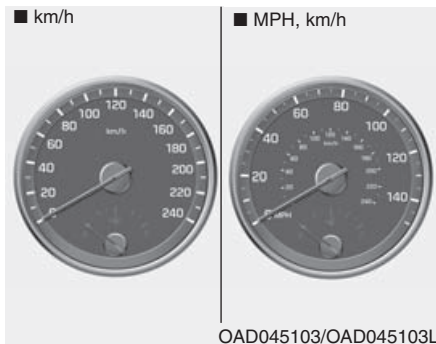

The speedometer indicates the speed of the vehicle and is calibrated in kilometers per hour (km/h) and/or miles per hour (MPH).

Tachometer

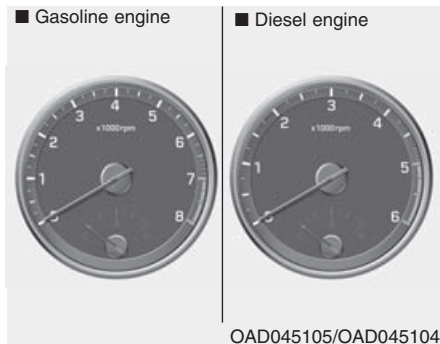

The tachometer indicates the approximate number of engine revolutions per minute (rpm).

Use the tachometer to select the correct shift points and to prevent lugging and/or over-revving the engine.

NOTICE

Do not operate the engine within the tachometer's RED ZONE. This may cause severe engine damage.

Engine Coolant Temperature gauge

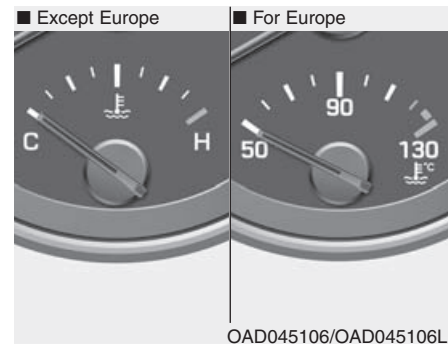

This gauge indicates the temperature of the engine coolant when the ignition switch is in the ON position.

NOTICE

If the gauge pointer moves beyond the normal range area toward the "130 or H (Hot)" position, it indicates overheating that may damage the engine.

Do not continue driving with an overheated engine. If your vehicle overheats, refer to "If the Engine Overheats" in chapter 6.

⚠ WARNING

Never remove the radiator cap or reservoir cap when the engine is hot. The engine coolant is under pressure and could cause severe burns. Wait until the engine is cool before adding coolant to the reservoir.

Fuel Gauge



This gauge indicates the approximate amount of fuel remaining in the fuel tank.

i Information

- The fuel tank capacity is given in chapter 8.
- The fuel gauge is supplemented by a low fuel warning light, which will illuminate when the fuel tank is nearly empty.
- On inclines or curves, the fuel gauge pointer may fluctuate or the low fuel warning light may come on earlier than usual due to the movement of fuel in the tank.

⚠ WARNING

Running out of fuel can expose vehicle occupants to danger. You must stop and obtain additional fuel as soon as possible after the warning light comes on or when the gauge indicator comes close to the "0 or E (Empty)" level.

NOTICE

Avoid driving with an extremely low fuel level. Running out of fuel could cause the engine to misfire, damaging the catalytic converter.

Outside Temperature Gauge

This gauge indicates the current outside air temperatures either in Celsius (°C) or Fahrenheit.

- Temperature range :
-40°C ~ 60°C (-40°F ~ 140°F)

The outside temperature on the display may not immediately change like a general thermometer not to distract the driver.

The temperature unit (from °C to °F or from °F to °C) can be changed by:

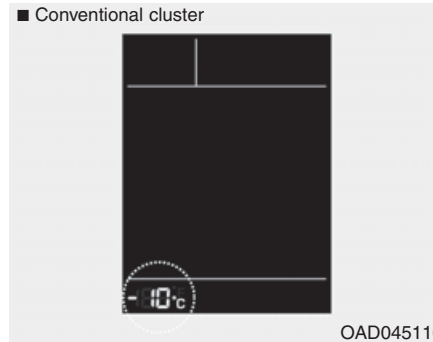

- Press the TRIP button for more than 5 seconds on the steering wheel.

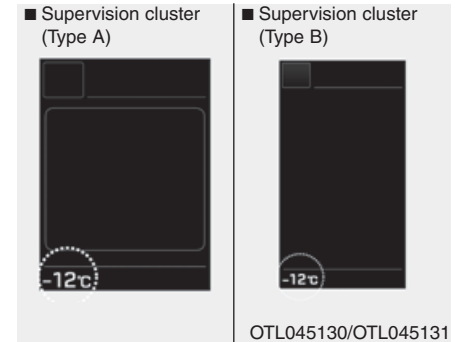

- User Settings mode in the Cluster :
You can change the temperature unit in the "Other Features - Temperature unit" .
- Automatic climate control system :
While pressing the OFF button, press the AUTO button for 3 seconds or more.

The temperature unit of the instrument cluster and climate control system will change at once.

Odometer

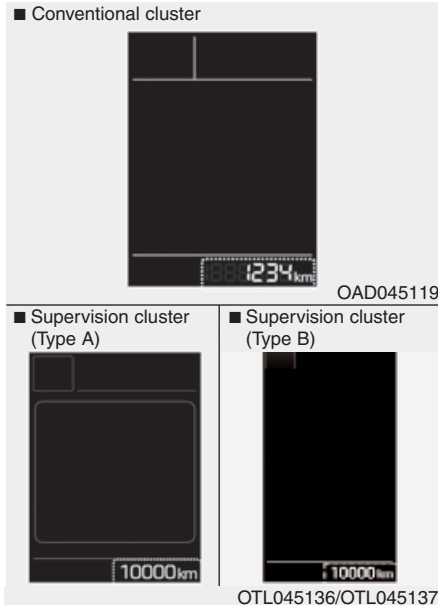

The odometer indicates the total distance that the vehicle has been driven and should be used to determine when periodic maintenance should be performed.

Warning and indicator lights

Information

Make sure that all warning lights are OFF after starting the engine. If any light is still ON, this indicates a situation that needs attention.

Air bag Warning Light



This warning light illuminates:

- Once you turn the ignition switch or the Engine Start/Stop button to the ON position.
 - It illuminates for approximately 6 seconds and then goes off.
- When there is a malfunction with the SRS.

In this case, we recommend that you have the vehicle inspected by an authorized HYUNDAI dealer.

Seat Belt Warning Light



This warning light informs the driver that the seat belt is not fastened.

For more details, refer to the “Seat Belts” in chapter 2.

Parking Brake & Brake Fluid Warning Light



This warning light illuminates:

- Once you turn the ignition switch or the Engine Start/Stop button to the ON position.
 - It illuminates for approximately 3 seconds
 - It remains on if the parking brake is applied.
- When the parking brake is applied.
- When the brake fluid level in the reservoir is low.
 - If the warning light illuminates with the parking brake released, it indicates the brake fluid level in reservoir is low.

If the brake fluid level in the reservoir is low:

1. Drive carefully to the nearest safe location and stop your vehicle.
2. With the engine stopped, check the brake fluid level immediately and add fluid as required (**For more details, refer to “Brake Fluid” in chapter 7**). After adding brake fluid, check all brake components for fluid leaks. If a brake fluid leak is found, or if the warning light remains on, or if the brakes do not operate properly, do not drive the vehicle. We recommend you to have the vehicle inspected by an authorized HYUNDAI dealer.

Dual-diagonal braking system

Your vehicle is equipped with dual-diagonal braking systems. This means you still have braking on two wheels even if one of the dual systems should fail.

With only one of the dual systems working, more than normal pedal travel and greater pedal pressure is required to stop the vehicle.

Also, the vehicle will not stop in as short a distance with only a portion of the brake system working.

If the brakes fail while you are driving, shift to a lower gear for additional engine braking and stop the vehicle as soon as it is safe to do so.

⚠ WARNING

Parking Brake & Brake Fluid Warning Light

Driving the vehicle with a warning light ON is dangerous. If the Parking Brake & Brake Fluid Warning Light illuminates with the parking brake released, it indicates that the brake fluid level is low.

In this case, we recommend that you have the vehicle inspected by an authorized HYUNDAI dealer.

Anti-lock Brake System (ABS) Warning Light



This warning light illuminates:

- Once you turn the ignition switch or the Engine Start/Stop button to the ON position.
 - It illuminates for approximately 3 seconds and then goes off.
- When there is a malfunction with the ABS (The normal braking system will still be operational without the assistance of the anti-lock brake system).

In this case, we recommend that you have the vehicle inspected by an authorized HYUNDAI dealer.

Electronic Brake force Distribution (EBD) System Warning Light



These two warning lights illuminate at the same time while driving:

- When the ABS and regular brake system may not work normally.
In this case, we recommend that you have the vehicle inspected by an authorized HYUNDAI dealer.

⚠ WARNING

Electronic Brake force Distribution (EBD) System Warning Light

When both ABS and Parking Brake & Brake Fluid Warning Lights are on, the brake system will not work normally and you may experience an unexpected and dangerous situation during sudden braking.

In this case, avoid high speed driving and abrupt braking.

We recommend you have the vehicle inspected by an authorized HYUNDAI dealer as soon as possible.

i Information - Electronic Brake force Distribution (EBD) System Warning Light

When the ABS Warning Light is on or both ABS and Parking Brake & Brake Fluid Warning Lights are on, the speedometer, odometer, or tripmeter may not work. Also, the EPS Warning Light may illuminate and the steering effort may increase or decrease.

In this case, we recommend you have the vehicle inspected by an authorized HYUNDAI dealer as soon as possible.

Electric Power Steering (EPS) Warning Light



This warning light illuminates:

- Once you turn the ignition switch or the Engine Start/Stop button to the ON position.
 - It illuminates for approximately 3 seconds and then goes off.
- When there is a malfunction with the EPS.

In this case, we recommend that you have the vehicle inspected by an authorized HYUNDAI dealer.

Malfunction Indicator Lamp (MIL)



This warning light illuminates:

- Once you turn the ignition switch or the Engine Start/Stop button to the ON position.
 - It illuminates for approximately 3 seconds and then goes off.
- When there is a malfunction with the emission control system.

In this case, we recommend that you have the vehicle inspected by an authorized HYUNDAI dealer.

NOTICE

Driving with the Malfunction Indicator Lamp (MIL) on may cause damage to the emission control systems which could affect drivability and/or fuel economy.

NOTICE - Gasoline Engine

If the Malfunction Indicator Lamp (MIL) illuminates, potential catalytic converter damage is possible which could result in loss of engine power.

In this case, we recommend that you have the vehicle inspected by an authorized HYUNDAI dealer as soon as possible.

NOTICE - Diesel Engine

If the Malfunction Indicator Lamp (MIL) blinks, some error related to the injection quantity adjustment occurs which could result in loss of engine power, combustion noise and poor emission.

In this case, we recommend that you have the engine control system inspected by an authorized HYUNDAI dealer.

Charging System Warning Light



This warning light illuminates:

- Once you turn the ignition switch or the Engine Start/Stop button to the ON position.
 - It remains on until the engine is started.
- When there is a malfunction with either the alternator or electrical charging system.

If there is a malfunction with either the alternator or electrical charging system:

1. Drive carefully to the nearest safe location and stop your vehicle.
2. Turn the engine off and check the alternator drive belt for looseness or breakage.

If the belt is adjusted properly, there may be a problem in the electrical charging system.

In this case, we recommend that you have the vehicle inspected by an authorized HYUNDAI dealer as soon as possible.

Engine Oil Pressure Warning Light



This warning light illuminates:

- Once you turn the ignition switch or the Engine Start/Stop button to the ON position.
 - It remains on until the engine is started.
- When the engine oil pressure is low.

If the engine oil pressure is low:

1. Drive carefully to the nearest safe location and stop your vehicle.
2. Turn the engine off and check the engine oil level (**For more details, refer to “Engine Oil” in chapter 7**). If the level is low, add oil as required. If the warning light remains on after adding oil or if oil is not available, we recommend that you have the vehicle inspected by an authorized HYUNDAI dealer as soon as possible.

NOTICE

- If the engine does not stop immediately after the Engine Oil Pressure Warning Light is illuminated, severe damage could result.
- If the warning light stays on while the engine is running, it indicates that there may be serious engine damage or malfunction. In this case,
 1. Stop the vehicle as soon as it is safe to do so.
 2. Turn off the engine and check the oil level. If the oil level is low, fill the engine oil to the proper level.
 3. Start the engine again. If the warning light stays on after the engine is started, turn the engine off immediately. In this case, we recommend that you have the vehicle inspected by an authorized HYUNDAI dealer.

Low Fuel Level Warning Light



This warning light illuminates:

- When the fuel tank is nearly empty. Add fuel as soon as possible.

NOTICE

Driving with the Low Fuel Level warning light on or with the fuel level below "0 or E" can cause the engine to misfire and damage the catalytic converter (if equipped).

Washer Fluid Warning Light (if equipped)



This warning light illuminates:

- When the washer fluid level in the reservoir is nearly empty.
In this case, you should refill the washer fluid.

Overspeed Warning Light (if equipped)

**120
km/h**

This warning light blinks:

- When you drive the vehicle more than 120 km/h.
 - This is to prevent you from driving your vehicle with overspeed.
 - The overspeed warning chime also sounds for approximately 5 seconds.

Master Warning Light (for supervision cluster)



This indicator light illuminates:

- Once you turn the ignition switch or Engine Start/Stop button to the ON position.
 - It illuminates for approximately 3 seconds and then goes off.
 - When there is a malfunction in operation in any of the following systems:
 - Low washer fluid (if equipped)
 - Exterior lamp malfunction
 - Blind Spot Detection (BSD) malfunction (if equipped)
 - Tire Pressure Monitoring System (TPMS, if equipped)
 - Service reminder
- To identify the details of the warning, look at the LCD display.

Low Tire Pressure Warning Light (if equipped)



This warning light illuminates:

- Once you turn the ignition switch or Engine Start/Stop button to the ON position.
 - It illuminates for approximately 3 seconds and then goes off.
- When one or more of your tires are significantly underinflated (The location of the underinflated tire is displayed on the supervision cluster LCD display).

For more details, refer to “Tire Pressure Monitoring System (TPMS)” in chapter 6.

This warning light remains ON after blinking for approximately 60 seconds, or repeatedly blinks ON and OFF in 3 second intervals:

- When there is a malfunction with the TPMS.
 - In this case, we recommend that you have the vehicle inspected by an authorized HYUNDAI dealer as soon as possible.

For more details, refer to “Tire Pressure Monitoring System (TPMS)” in chapter 6.

WARNING

Safe Stopping

- The TPMS cannot alert you to severe and sudden tire damage caused by external factors.
- If you notice any vehicle instability, immediately take your foot off the accelerator pedal, apply the brakes gradually with light force, and slowly move to a safe position off the road.

Fuel Filter Warning Light (for diesel engine)



This warning light illuminates:

- When water has accumulated inside the fuel filter.
 - In this case, remove the water from the fuel filter.

For more details, refer to “Fuel Filter” in chapter 7.

NOTICE

- When the Fuel Filter Warning Light illuminates, engine power (vehicle speed & idle speed) may decrease.
- If you keep driving with the warning light on, engine parts (injector, common rail, high pressure fuel pump) may be damaged. If this occurs, we recommend that you have the vehicle inspected by an authorized HYUNDAI dealer as soon as possible.

Exhaust System (DPF) Warning Light (for diesel engine)



This warning light illuminates:

- When there is a malfunction with Diesel Particulate Filter (DPF) system.
- When this warning light illuminates, it may turn off after driving the vehicle:
 - at more than 60 km/h (37 mph), or
 - at more than 2nd gear with 1500 ~ 2000 engine rpm for a certain time (for about 25 minutes).

If this warning light blinks in spite of the procedure (at this time LCD warning message will be displayed), we recommend that you have the DPF system checked by an authorized HYUNDAI dealer.

NOTICE

If you continue to drive with the DPF warning light blinking for a long time, the DPF system can be damaged and fuel consumption can worsen.

Glow Indicator Light (for diesel engine)



This indicator light illuminates:

- When the engine is being preheated with the ignition switch or Engine Start/Stop Button in the ON position.
 - The engine can be started after the glow indicator light goes off.
 - The illumination time varies with the engine coolant temperature, air temperature, and battery condition.

If the indicator light remains on or blinks after the engine has warmed up or while driving, there may be a malfunction with the engine preheating system.

In this case, we recommend that you have the vehicle inspected by an authorized HYUNDAI dealer.

i Information

If the engine does not start within 10 seconds after the preheating is completed, set the ignition switch or Engine Start/Stop Button to the LOCK or OFF position for 10 seconds and then to the ON position in order to preheat the engine again.

Door Ajar Warning Light (for conventional cluster)



This warning light illuminates:

- When a door is not closed securely.

Trunk Open Warning Light (for conventional cluster)



This warning light illuminates:

- When the trunk is not closed securely.

Electronic Stability Control (ESC) Indicator Light (if equipped)



This indicator light illuminates:

- Once you turn the ignition switch or the Engine Start/Stop button to the ON position.
 - It illuminates for approximately 3 seconds and then goes off.
- When there is a malfunction with the ESC system.

In this case, we recommend that you have the vehicle inspected by an authorized HYUNDAI dealer.

This indicator light blinks:

- While the ESC is operating.

For more details, refer to “Electronic Stability Control (ESC)” in chapter 5.

Electronic Stability Control (ESC) OFF Indicator Light (if equipped)



This indicator light illuminates:

- Once you turn the ignition switch or the Engine Start/Stop button to the ON position.
 - It illuminates for approximately 3 seconds and then goes off.
- When you deactivate the ESC system by pressing the ESC OFF button.

For more details, refer to “Electronic Stability Control (ESC)” in chapter 5.

AUTO STOP Indicator Light (if equipped)



This indicator light illuminates:

- When the engine enters the Idle Stop mode of the ISG (Idle Stop and Go) system.
- When the automatic starting occurs, the AUTO STOP indicator on the cluster will blink for 5 seconds.

For more details, refer to the “ISG (Idle Stop and Go) system” in chapter 5.

***i* Information**

When the engine automatically starts by the ISG system, some warning lights (ABS, ESC, ESC OFF, EPS or Parking brake warning light) may turn on for a few seconds.

This happens because of low battery voltage. It does not mean the system has malfunctioned.

Immobilizer Indicator Light (without smart key) (if equipped)



This indicator light illuminates:

- When the vehicle detects the immobilizer in the key with the ignition switch in the ON position.
 - At this time, you can start the engine.
 - The indicator light goes off after starting the engine.

This indicator light blinks:

- When there is a malfunction with the immobilizer system.

In this case, we recommend that you have the vehicle inspected by an authorized HYUNDAI dealer.

Immobilizer Indicator Light (with smart key) (if equipped)



This indicator light illuminates for up to 30 seconds:

- When the vehicle detects the smart key in the vehicle with the Engine Start/Stop button in the ACC or ON position.
 - At this time, you can start the engine.
 - The indicator light goes off after starting the engine.

This indicator light blinks for a few seconds:

- When the smart key is not in the vehicle.
 - At this time, you cannot start the engine.

This indicator light illuminates for 2 seconds and goes off:

- If the smart key is in the vehicle and the Engine Start/Stop button is ON., but the vehicle cannot detect the smart key.

In this case, we recommend that you have the vehicle inspected by an authorized HYUNDAI dealer.

This indicator light blinks:

- When the battery voltage of the smart key is low.
 - At this time, you can not start the engine. However, you can start the engine if you press the Engine Start/Stop button with the smart key. **(For more details, refer to "Starting the Engine" in chapter 5).**
- When there is a malfunction with the immobilizer system.

In this case, we recommend that you have the vehicle inspected by an authorized HYUNDAI dealer.

Turn Signal Indicator Light

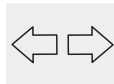

This indicator light blinks:

- When you operate the turn signal indicator light.

If any of the following occurs, there may be a malfunction with the turn signal system.

- The turn signal indicator light illuminates but does not blink
- The turn signal indicator light blinks rapidly
- The turn signal indicator light does not illuminate at all

If either of these conditions occur, we recommend you to have your vehicle inspected by an authorized HYUNDAI dealer.

Low Beam Indicator Light (if equipped)



This indicator light illuminates:

- When the headlights are on.

High Beam Indicator Light



This indicator light illuminates:

- When the headlights are on and in the high beam position
- When the turn signal lever is pulled into the Flash-to-Pass position.

Light ON Indicator Light



This indicator light illuminates:

- When the tail lights or headlights are on.

Front Fog Indicator Light (if equipped)



This indicator light illuminates:

- When the front fog lights are on.

Rear Fog Indicator Light (if equipped)



This indicator light illuminates:

- When the rear fog lights are on.

Exterior Light Warning Light (if equipped) (for conventional cluster)



This warning light illuminates:

- When one of the exterior bulbs (headlamp, tail lamp, fog lamp, etc.) is not operating properly. One of the bulbs may need to be replaced.

***i* Information**

Make sure to replace the burned out bulb with a new one of the same wattage rating.

***Cruise Indicator Light
(for conventional
cluster, if equipped)***

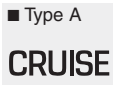

This indicator light illuminates:

- When the cruise control system is enabled.

For more details, refer to “Cruise Control System” in chapter 5.

***Cruise SET Indicator
Light (for conventional
cluster, if equipped)***



This indicator light illuminates:

- When the cruise control speed is set.

For more details, refer to “Cruise Control System” in chapter 5.

***SPORT Mode Indicator
Light (if equipped)***



This indicator light illuminates

- When you select "SPORT" mode as drive mode.

For more details, refer to "Drive Mode Integrated Control System" in chapter 5.

***ECO Mode Indicator
Light (if equipped)***



This indicator light illuminates:

- When you select “ECO” mode as drive mode.

For more details, refer to “Drive Mode Integrated Control System” in chapter 5.

LCD display messages

Shift to "P" position (for smart key system and automatic transmission/dual clutch transmission)

■ Supervision cluster

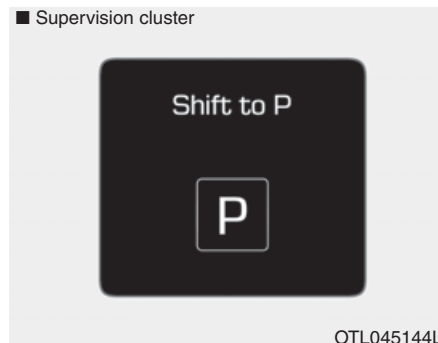

OTL045144L

This warning message is displayed if you try to turn off the engine without the shift lever in P (Park) position.

At this time, the Engine Start/Stop button turns to the ACC position (If you press the Engine Start/Stop button once more, it will turn to the ON position).

Low Key Battery (for smart key system)

■ Supervision cluster

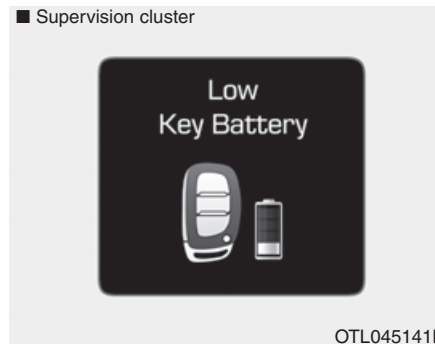

OTL045141L

This warning message is displayed if the battery of the smart key is discharged while changing the Engine Start/Stop button while changing to the OFF position.

Press start button while turning wheel (for smart key system)

■ Supervision cluster



OTL045300L

This warning message is displayed if the steering wheel does not unlock normally when the Engine Start/Stop button is pressed.

You should press you should press the Engine Start/Stop button while turning the steering wheel right and left.

**Steering wheel unlocked
(for smart key system)**

■ Supervision cluster



OTL045301L

This warning message is displayed if the steering wheel does not lock while the Engine Start/Stop button changes to the OFF position.

**Check steering wheel lock
system (for smart key system)**

■ Supervision cluster



OTL045302L

This warning message is displayed if the steering wheel does not lock normally while the Engine Start/Stop button changes to the OFF position.

**Press brake pedal to start engine
(for smart key system and auto-
matic transmission)**

■ Supervision cluster



OTL045142L

This warning message is displayed if the Engine Start/Stop button changes to the ACC position twice by pressing the button repeatedly without depressing the brake pedal.

You can start the vehicle by depressing the brake pedal.

Press clutch pedal to start engine (for smart key system and manual transmission)

■ Supervision cluster



OTL045143L

This warning message is displayed if the Engine Start/Stop button is in the ACC position twice by pressing the button repeatedly without depressing the clutch pedal.

Depress the clutch pedal to start the engine.

Key not in vehicle (for smart key system)

■ Supervision cluster



OTL045138L

This warning message is displayed if the smart key is not in the vehicle when you press the Engine Start/Stop button.

It means that you always have the smart key with you.

Key not detected (for smart key system)

■ Supervision cluster



OTL045139L

This warning message is displayed if the smart key is not detected when you press the Engine Start/Stop button.

**Press start button again
(for smart key system)**



This message is displayed if you were unable to start the vehicle when the Engine Start/Stop button was pressed.

If this occurs, attempt to start the engine by pressing the Engine Start/Stop button again.

If the warning message appears each time you press the Engine Start/Stop button, we recommend you to have your vehicle inspected by an authorized HYUNDAI dealer.

**Press "START" button with key
(for smart key system)**



This warning message is displayed if you press the Engine Start/Stop button while the warning message "Key not detected" is displayed.

At this time, the immobilizer indicator light blinks.

**Check "BRAKE SWITCH" fuse
(for smart key system and auto-
matic transmission/dual clutch
transmission)**

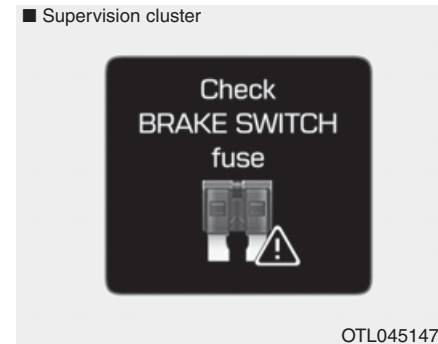

This warning message is displayed if the brake switch fuse is disconnected.

You need to replace the fuse with a new one before starting the engine.

If that is not possible, you can start the engine by pressing the Engine Start/Stop button for 10 seconds in the ACC position.

Shift to "P" or "N" to start engine (for smart key system and auto- matic transmission/dual clutch transmission)

■ Supervision cluster



This warning message is displayed if you try to start the engine with the shift lever not in the P (Park) or N (Neutral) position.

***i* Information**

You can start the engine with the shift lever in the N (Neutral) position. But, for your safety, we recommend that you start the engine with the shift lever in the P (Park) position.

Door, Hood, Trunk Open

■ Supervision cluster

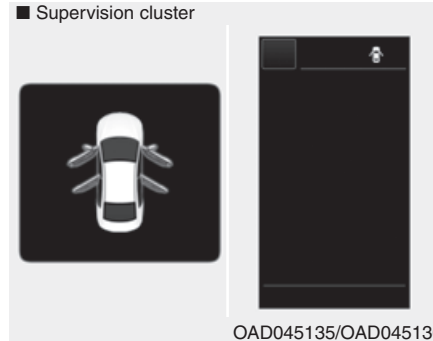

This warning message is displayed indicating which door, or the hood, or the trunk is open.

If the door/trunk open warning message is blocked with another warning message, an icon will appear on the top of the LCD display.

Sunroof Open (if equipped)

■ Conventional cluster

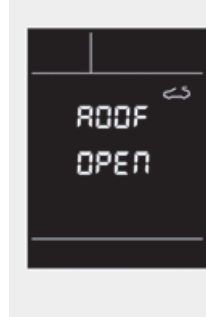

■ Supervision cluster



This warning is displayed if you turn off the engine when the sunroof is open.

Heated Steering Wheel Off (if equipped)

■ Supervision cluster



OTL045167L

This warning message is displayed if you turn off the heated steering wheel.

For more details, refer to “Heated Steering Wheel” in this chapter.

Icy Road Warning Light (if equipped)

■ Conventional cluster



OAD045186N

■ Supervision cluster
(Type A)

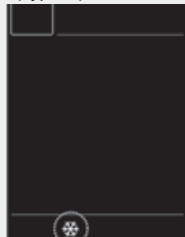

■ Supervision cluster
(Type B)



OAD055094L/OAD055095L

This warning light is to warn the driver the road may be icy.

When the temperature on the outside temperature gauge is approximately below 4°C (40°F), the Icy Road Warning Light and Outside Temperature Gauge blinks 10 times, and then illuminates. Also, the warning chime sounds 1 time.

i Information

If the icy road warning light appears while driving, you should drive more attentively and safely refraining from over-speeding, rapid acceleration, sudden braking or sharp turning, etc.

Transmission shift indicator

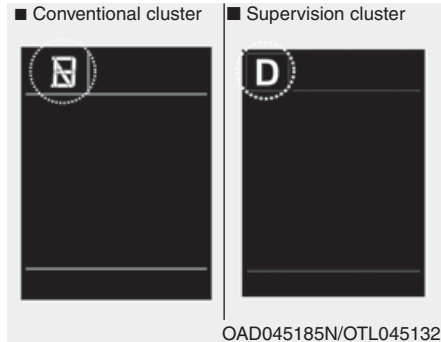

Automatic Transmission Shift Indicator (if equipped)

This indicator displays which shift lever is selected.

- Park : P
- Reverse : R
- Neutral : N
- Drive : D
- Sports Mode : 1, 2, 3, 4, 5, 6

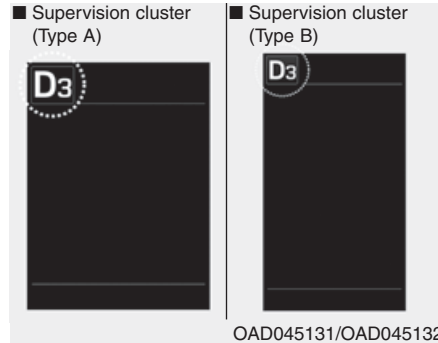

Dual Clutch Transmission Shift Indicator (if equipped)

This indicator displays which shift lever is selected.

- Park : P
- Reverse : R
- Neutral : N
- Drive : D
- Sports Mode : D1, D2, D3, D4, D5, D6, D7

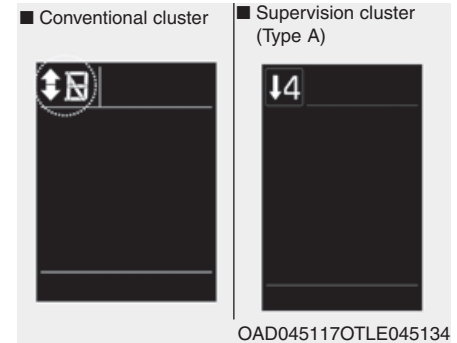

Manual Transmission Shift Indicator (if equipped)

This indicator informs which gear is desired while driving to save fuel.

- Shifting up : ▲2, ▲3, ▲4, ▲5, ▲6
- Shifting down : ▼1, ▼2, ▼3, ▼4, ▼5

For example

▲3 : Indicates that shifting up to the 3rd gear is desired (currently the shift lever is in the 2nd or 1st gear).

▼3 : Indicates that shifting down to the 3rd gear is desired (currently the shift lever is in the 4th, 5th, or 6th gear).

When the system is not working properly, the indicator is not displayed.

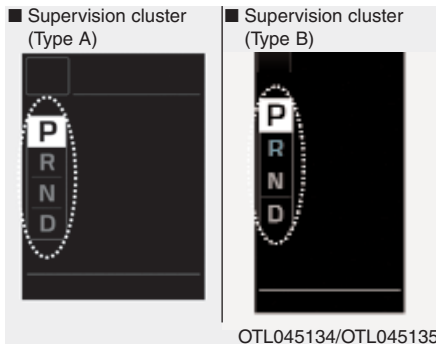

Shift Indicator Pop-up (if equipped)

The pop-up that indicates the current gear position is displayed in the cluster for about 2 seconds when shifting into other positions (P/R/N/D).

CRUISE/SET indicator (if equipped)



The indicator is displayed when the cruise control system is enabled and the cruise control speed is set.

For more details, refer to "Cruise Control System" in chapter 5.

Low Pressure (if equipped)

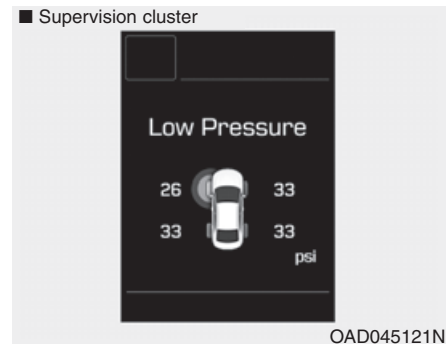

This warning message is displayed if the tire pressure is low. The corresponding tire on the vehicle will be illuminated.

For more details, refer to "Tire Pressure Monitoring System (TPMS)" in chapter 6.

Turn on "FUSE SWITCH"

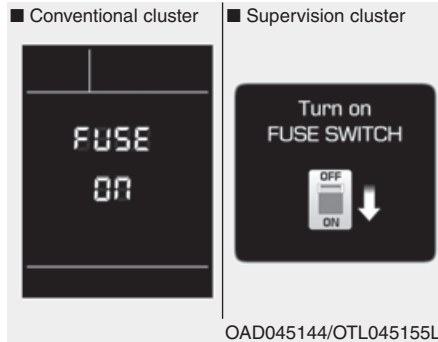

This warning message is displayed if the fuse switch located on the fuse box under the steering wheel is OFF. You should turn the fuse switch on.

For more details, refer to "Fuses" in chapter 7.

Align steering wheel (if equipped)



This warning message is displayed if you start the engine when the steering wheel is turned to more than 90 degrees to the left or right.

In order to align the steering wheel, turn the wheel in the direction shown while the engine is running to straighten the steering wheel.

Steering wheel aligning is completed (if equipped)



If the steering wheel aligning is completed after "Align steering wheel" warning message is displayed, this message is displayed for 2 seconds.

Low Washer Fluid (if equipped)

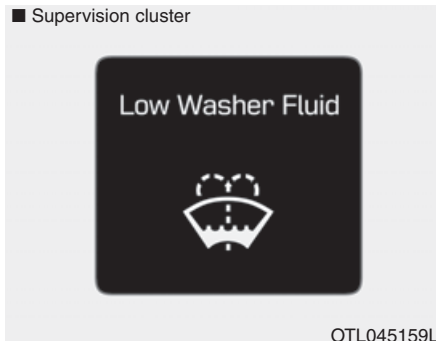

This warning message is displayed in the service reminder mode if the washer fluid level in the reservoir is nearly empty.

Have the washer fluid reservoir refilled.

Low Fuel

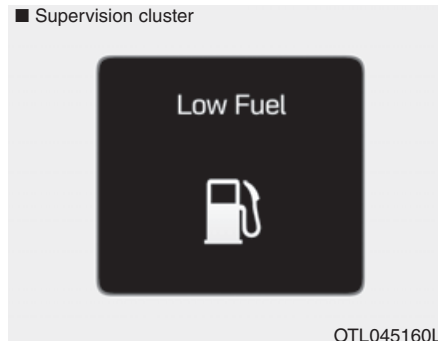

This warning message is displayed if the fuel tank is almost out of fuel.

When this message is displayed, the low fuel level warning light in the cluster will come on.

It is recommended to look for the nearest fueling station and refuel as soon as possible.

Add fuel as soon as possible.

Engine has overheated

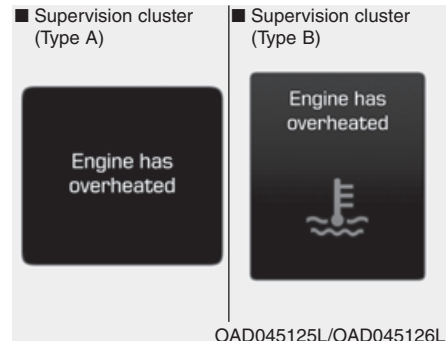

This warning message is displayed when the engine coolant temperature is above 120°C (248°F). This means that the engine is overheated and may be damaged.

If your vehicle is overheated, refer to "Overheating" in chapter 6.

Check headlight (if equipped)

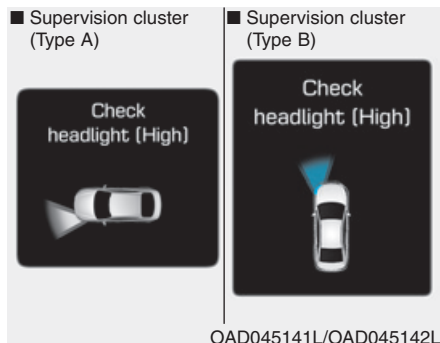

This warning message is displayed if the headlamps are not operating properly. The headlamp bulb may need to be replaced.

i Information

Make sure to replace the burned out bulb with a new one of the same wattage rating.

Diesel Particulate Filter (DPF) warning (for diesel engine)

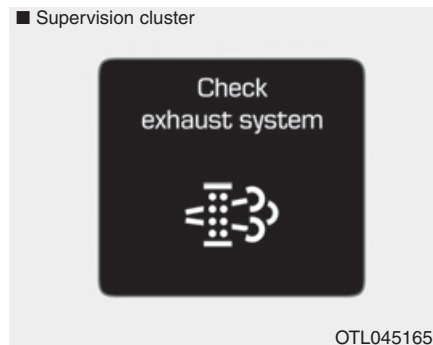

This warning message is displayed if the DPF system has a malfunction. At this time, DPF warning light also blinks.

In this case, we recommend that you have the DPF system checked by an authorized HYUNDAI dealer.



For more details, refer to "Warning Lights" in this chapter.

LCD DISPLAY (FOR SUPERVISION CLUSTER)

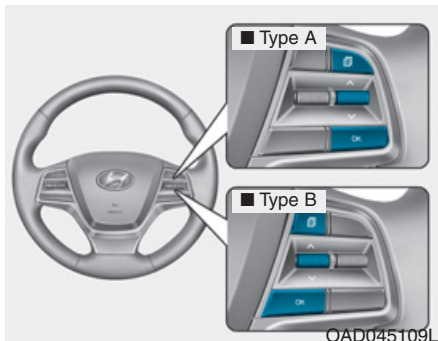





LCD display control



The LCD display modes can be changed by using the control buttons.

- (1)  : MODE button for changing modes
- (2)  ,  : MOVE switch for changing items
- (3) OK : SELECT/RESET button for setting or resetting the selected item

LCD modes

Modes	Symbol	Explanation
Trip Computer		This mode displays driving information like the tripmeter, fuel economy, etc. For more details, refer to "Trip Computer" in this chapter.
Turn By Turn (TBT) (if equipped)		This mode displays the state of the navigation.
A/V (If equipped)		This mode displays the state of the A/V system.
Information	 or  or 	This mode displays the service interval (mileage or days) and warning messages related to the Blind Spot Detection system, etc.
User Settings		In this mode, you can change settings of the doors, lamps, etc.

Edit settings after engaging parking brake / Edit settings after shifting to P

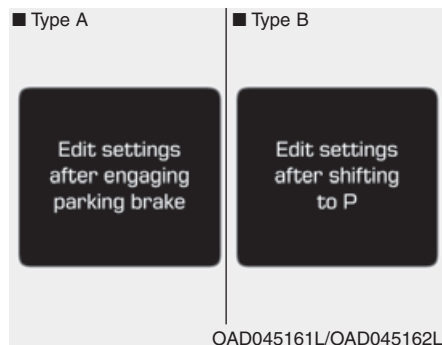

This warning message appears if you try to adjust the User Settings while driving.

- Automatic transmission / dual clutch transmission

For your safety, change the User Settings after parking the vehicle, applying the parking brake and moving the shift lever to P (Park).

- Manual transmission

For your safety, change the User Settings after engaging the parking brake.

Quick guide (Help, if equipped)

This mode provides quick guides for the systems in the User Settings mode.

Select an item, press and hold the OK button.

For more details about each system, refer to this Owner's Manual.

Trip computer mode

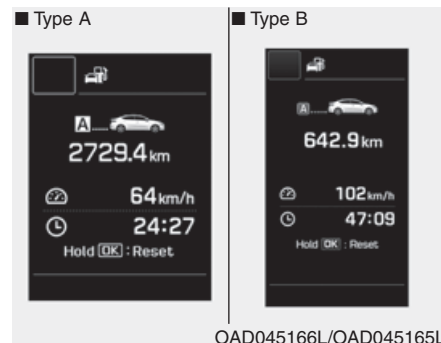

The trip computer mode displays information related to vehicle driving parameters including fuel economy, trip meter information and vehicle speed.

For more details, refer to "Trip Computer" in this chapter.

Turn By Turn (TBT) mode (if equipped)

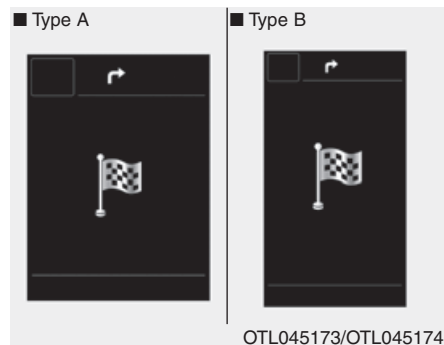

This mode displays the state of the navigation.

A/V mode (if equipped)

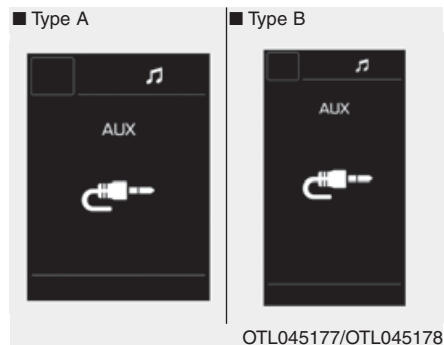

This mode displays the state of the A/V system.

Information mode

This mode displays the service interval (mileage and days).



Service interval

Service in

It calculates and displays the maintenance schedule (mileage or days), as set in the system.

When the set mileages or days passed, "Service in" message is displayed for several seconds each time ignition switch is turned ON.

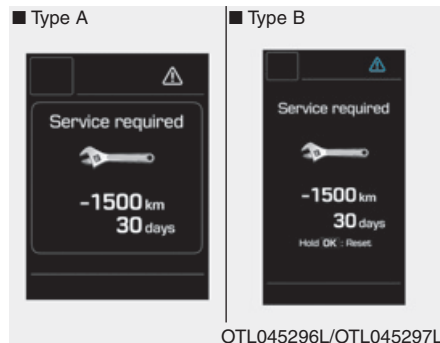

Service required

If you exceed the specified service interval, a message indicating, "Service required" will be displayed each time you turn ON the vehicle.

To reset the service interval in mileages or days that you initially set:

- Activate the reset mode by pressing the OK button for more than 5 second, then press the OK button again for more than 1 second (for Europe).
- Press the OK button for more than 1 second (except Europe).

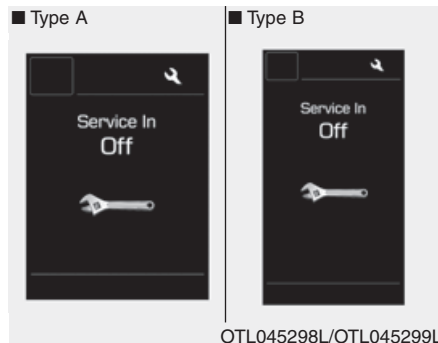

Service in OFF

If the service interval is not set, "Service in OFF" message is displayed on the LCD display.

i Information

If any of the following conditions occur, the mileage and number of days to service may be incorrect.

- **The battery cable is disconnected.**
- **The fuse switch is turned off.**
- **The battery is discharged.**

Warning message

If one of followings occurs, warning messages will be displayed in the information mode for several seconds.

- Low washer fluid (if equipped)
- Exterior lamp malfunction
- Blind Spot Detection (BSD) malfunction (if equipped)
- Tire Pressure Monitoring System (TPMS, if equipped)
- Service reminder

User settings mode

In this mode, you can change setting of the instrument cluster, doors, lamps, and so on.

Driving Assist (if equipped)

Items	Explanation
Rear Cross Traffic Alert (if equipped)	If this item is checked, the rear cross traffic alert function will be activated. For more details, refer to "Blind Spot Detection System" in chapter 5.

Door

Items	Explanation
Auto Lock	<ul style="list-style-type: none"> • Disable : The automatic door lock operation will be deactivated. • Enable on Speed: All doors will be automatically locked when the vehicle speed exceeds 15km/h (9.3mph). • Enable on Shift: All doors will be automatically locked if the automatic transmission shift lever is shifted from the P (Park) position to the R (Reverse), N (Neutral), or D (Drive) position.
Auto Unlock	<ul style="list-style-type: none"> • Disable : The automatic door unlock operation will be canceled. • On key out : All doors will be automatically unlocked when the ignition key is removed from the ignition switch or the Engine Star/Stop button is set to the OFF position. • Driver Door Unlock: All doors will be automatically unlocked if the driver's door is unlocked. • On Shift to P: All doors will be automatically unlocked if the automatic transmission shift lever is shifted to the P (Park) position.

(Continued)

(Continued)

Items	Explanation
Horn Feedback	If this item is checked, the horn feedback operation will be activated. After locking the door by pressing the lock button on the remote key, if you press the lock button again within 4 seconds, the warning sound will operate once to indicate that all doors are locked.
Smart Trunk (if equipped)	If this item is checked, the smart trunk function will be activated. For more details, refer to "Smart Trunk" in this chapter.

Light

Items	Explanation
One Touch Turn Signal	<ul style="list-style-type: none"> • Off: The one touch turn signal function will be deactivated. • 3, 5, 7 Flashes : The lane change signals will blink 3, 5, or 7 times when the turn signal lever is moved slightly. For more details, refer to "Light" in this chapter.
Head Lamp Delay	<ul style="list-style-type: none"> • If this item is checked, the head lamp delay function will be activated.
Welcome light (if equipped)	<ul style="list-style-type: none"> • If this item is checked, the welcome light function will be activated.

Sound

Items	Explanation
Cluster Voice Guidance Volume	<ul style="list-style-type: none"> To adjust the cluster voice guidance volume (Level 0~3)
Park Assist System Vol. (if equipped)	<ul style="list-style-type: none"> To adjust the Park Assist System volume. (Level 1~3) <p>For more details, refer to "Parking Assist System" in this chapter.</p>
Blind Spot Detection Sound (if equipped)	<ul style="list-style-type: none"> If this item is checked, the blind spot detection sound will be activated. <p>For more details, refer to "Blind Spot Detection System" in chapter 5.</p>
Welcome sound (if equipped)	<ul style="list-style-type: none"> If this item is checked, the welcome sound function will be activated.

Convenience

Items	Explanation
Seat Easy Access	<ul style="list-style-type: none"> None: The seat easy access function is deactivated. Normal/Extended: <ul style="list-style-type: none"> When you turn off the engine, the driver's seat will automatically move rearward short (Normal) or long (Extended) for you to enter or exit the vehicle more comfortably. If you change the Engine Start/Stop button from OFF position to the ACC, ON, or START position, the driver's seat will return to the original position. <p>For more information, refer to "Driver Position Memory System" in this chapter.</p>
Steering Position (if equipped)	If this item is checked, the message "Align Steering Wheel" will be displayed on the LCD if the steering wheel has been turned to the left or right over 90 degrees when the engine is turned ON.
Gear Position Pop-up (if equipped)	If this item is checked, the gear position will be displayed when you move the shift lever.

Service interval

Items	Explanation
Service Interval (Except Europe)	<p>In this mode, you can activate the service interval function with mileage (km or mi.) and period (days)</p> <ul style="list-style-type: none"> • Off : The service interval function will be deactivated. • On : You can set the service interval (mileage and days). <p>For more details, refer to "Information Mode" in this chapter.</p>

Other features

Items	Explanation
Fuel Economy Auto Reset	<ul style="list-style-type: none"> • Off : The average fuel economy will not reset automatically whenever refueling. • After Ignition : The average fuel economy will reset automatically when driving. • After Refueling : The average fuel economy will reset automatically when refueling. <p>For more details, refer to "Trip Computer" in this chapter.</p>
Fuel Economy Unit	Choose the fuel economy unit. (Km/L, L/100)
Temperature Unit	Choose the temperature unit. (°C, °F)
Tire Pressure Unit (if equipped)	Choose the tire pressure unit. (psi, kPa, bar)
Language	Choose the language.

TRIP COMPUTER

Conventional cluster

The trip computer is a microcomputer-controlled driver information system that displays information related to driving.

i Information

Some driving information stored in the trip computer (for example Average Vehicle Speed) resets if the battery is disconnected.

Trip modes

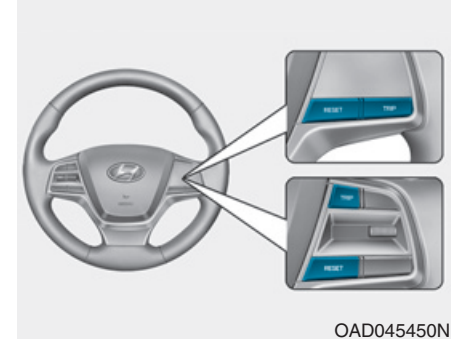
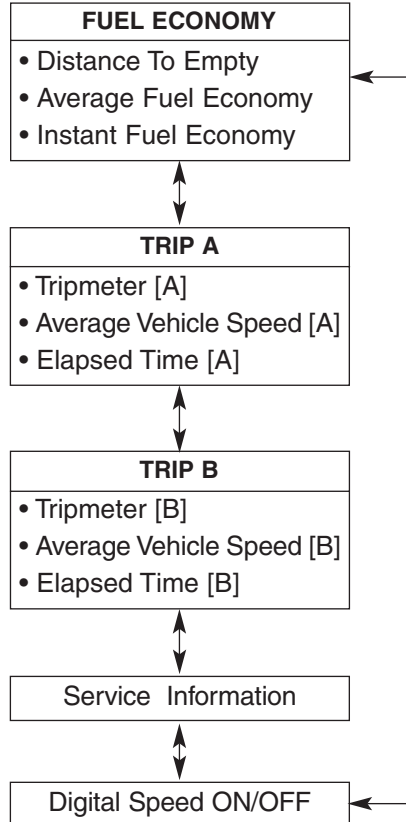

To change the trip mode, press the TRIP button on the steering wheel.

Fuel economy

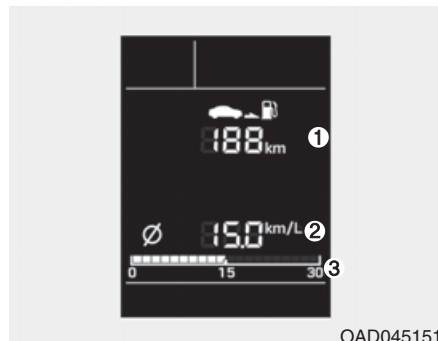

Distance To Empty (1)

- The distance to empty is the estimated distance the vehicle can be driven with the remaining fuel.
 - Distance range:
1 ~ 9999 km or 1 ~ 9999 mi.
- If the estimated distance is below 1 km (1 mi.), the trip computer will display "----" as distance to empty.

i Information

- If the vehicle is not on level ground or the battery power has been interrupted, the distance to empty function may not operate correctly.
- The distance to empty may differ from the actual driving distance as it is an estimate of the available driving distance.
- The trip computer may not register additional fuel if less than 3 liters (1 gallon) of fuel are added to the vehicle.
- The fuel economy and distance to empty may vary significantly based on driving conditions, driving habits, and condition of the vehicle.

Average Fuel Economy (2)

- The average fuel economy is calculated by the total driving distance and fuel consumption since the last average fuel economy reset.
 - Fuel economy range:
0.0 ~ 99.9 L/100km, km/L or MPG
- To clear the average fuel economy manually, press the RESET button on the steering wheel for more than 1 second when the average fuel economy is displayed.

Instant Fuel Economy (3)

- This mode displays the instantaneous fuel economy while driving when the vehicle speed is greater than 10 km/h (6.2 mph).
 - Fuel economy range:
0~30 L/100km, km/L or 0~50 MPG

Trip A/B

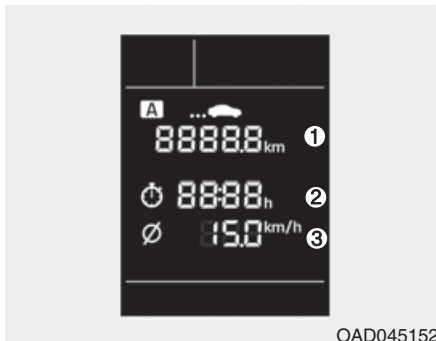

Tripmeter (1)

- The tripmeter is the total driving distance since the last tripmeter reset.
 - Distance range:
0.0 ~ 9999.9 km or mi.
- To reset the tripmeter, press the RESET button on the steering wheel for more than 1 second when the tripmeter is displayed.

Average Vehicle Speed (2)

- The average vehicle speed is calculated by the total driving distance and driving time since the last average vehicle speed reset.
 - Speed range:
0 ~ 240 km/h or 0 ~ 160 MPH
- To reset the average vehicle speed, press the RESET button on the steering wheel for more than 1 second when the average vehicle speed is displayed.

i Information

- **The average vehicle speed is not displayed if the driving distance is less than 300 meters (0.19 miles) or the driving time is less than 10 seconds since the ignition switch or the Engine Start/Stop button is turned to ON.**
- **The average vehicle speed will continue to be calculated and will start to decrease if the vehicle is stopped while the engine is still running (for example, when the vehicle is in traffic or stopped at a stop light.)**

Elapsed Time (3)

- The elapsed time is the total driving time since the last elapsed time reset.
 - Time range (hh:mm):
00:00 ~ 99:59
- To reset the elapsed time, press the RESET button on the steering wheel for more than 1 second when the elapsed time is displayed.

i Information

The elapsed time will continue to be counted while the engine is still running (for example, when the vehicle is in traffic or stopped at a stop light.)

Service information



OAD045179N

If the remaining mileage or time reaches 1,500 km (900 miles) or 30 days, the service symbol () will blink for several seconds each time you set the ignition switch or Engine Start/Stop button to the ON position.

Information

To change or deactivate the service interval, consult an authorized HYUNDAI dealer.



OAD045182N

If you exceed the specified service interval, the service symbol () will blink each time you turn ON the vehicle.

To reset the service interval, press the RESET button for more than 5 seconds and then when the miles and days blink press the RESET button for more than 1 second.

If the service interval is not set, the service symbol () will not be displayed.

Digital speedometer

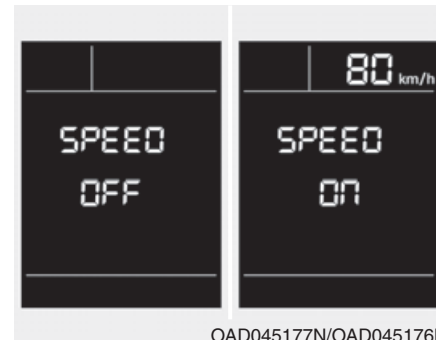

OAD045177N/OAD045176N

This message shows the speed of the vehicle (in mph, km/h).

To turn the digital speedometer ON and OFF press the RESET button for more than 1 second when the digital speedometer is displayed.

Supervision cluster

The trip computer is a microcomputer-controlled driver information system that displays information related to driving.

i Information

Some driving information stored in the trip computer (for example Average Vehicle Speed) resets if the battery is disconnected.

Trip modes

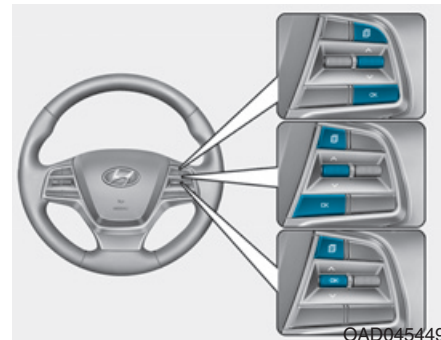
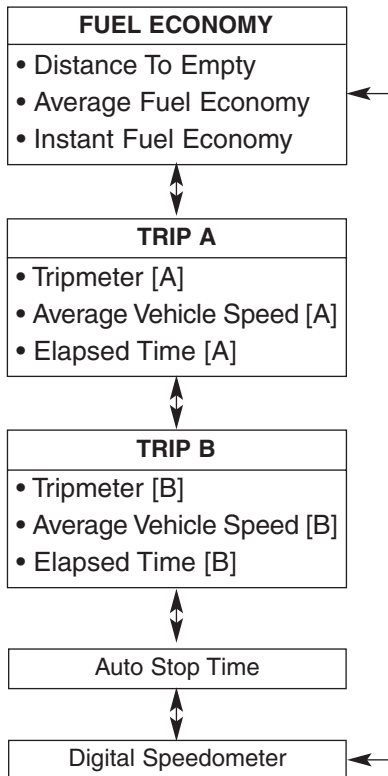

To change the trip mode, toggle the “▲, ▼” switch on the steering wheel.

Fuel economy

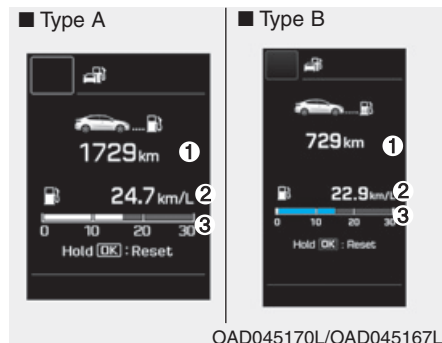

Distance To Empty (1)

- The distance to empty is the estimated distance the vehicle can be driven with the remaining fuel.
 - Distance range:
1 ~ 9999 km or 1 ~ 9999 mi.
- If the estimated distance is below 1 km (1 mi.), the trip computer will display "----" as distance to empty.

i Information

- If the vehicle is not on level ground or the battery power has been interrupted, the distance to empty function may not operate correctly.
- The distance to empty may differ from the actual driving distance as it is an estimate of the available driving distance.
- The trip computer may not register additional fuel if less than 3 liters (1 gallon) of fuel are added to the vehicle.
- The fuel economy and distance to empty may vary significantly based on driving conditions, driving habits, and condition of the vehicle.

Average Fuel Economy (2)

- The average fuel economy is calculated by the total driving distance and fuel consumption since the last average fuel economy reset.
 - Fuel economy range:
0.0 ~ 99.9 L/100km, km/L or MPG
- The average fuel economy can be reset both manually and automatically.

Manual reset

To clear the average fuel economy manually, press the [OK] button on the steering wheel for more than 1 second when the average fuel economy is displayed.

Automatic reset

To automatically reset the average fuel economy after refueling, select the "Auto Reset" mode in User Settings menu on the LCD display (**Refer to "LCD Display" in this chapter**).

In "Auto Reset" mode, the average fuel economy will be reset to zero (----), when driving speed exceeds 1 km/h, after adding 3~6 liters (1~2 gallon) of fuels or more.

Information

The vehicle must be driven for a minimum of 300 meters (0.19 miles) since the last ignition key cycle before the average fuel economy will be recalculated.

Instant Fuel Economy (3)

- This mode displays the instantaneous fuel economy while driving when the vehicle speed is greater than 10 km/h (6.2 mph).
 - Fuel economy range: 0~30 L/100km, km/L or 0~50 MPG

Trip A/B

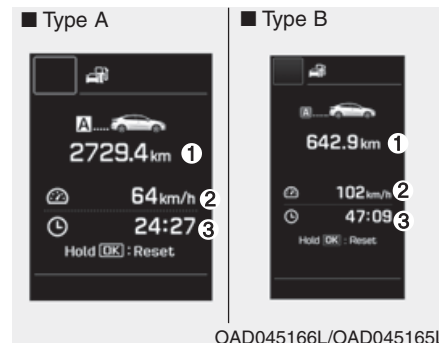

Tripmeter (1)

- The tripmeter is the total driving distance since the last tripmeter reset.
 - Distance range: 0.0 ~ 9999.9 km or mi.
- To reset the tripmeter, press the [OK] button on the steering wheel for more than 1 second when the tripmeter is displayed.

Average Vehicle Speed (2)

- The average vehicle speed is calculated by the total driving distance and driving time since the last average vehicle speed reset.
 - Speed range:
0~240 km/h or 0~160 MPH
- To reset the average vehicle speed, press the [OK] button on the steering wheel for more than 1 second when the average vehicle speed is displayed.

i Information

- The average vehicle speed is not displayed if the driving distance is less than 300 meters (0.19 miles) or the driving time is less than 10 seconds since the ignition switch or the Engine Start/Stop button is turned to ON.
- The average vehicle speed will continue to be calculated and will start to decrease if the vehicle is stopped while the engine is still running (for example, when the vehicle is in traffic or stopped at a stop light.)

Elapsed Time (3)

- The elapsed time is the total driving time since the last elapsed time reset.
 - Time range (hh:mm):
00:00 ~ 99:59
- To reset the elapsed time, press the [OK] button on the steering wheel for more than 1 second when the elapsed time is displayed.

i Information

The elapsed time will continue to be counted while the engine is still running (for example, when the vehicle is in traffic or stopped at a stop light.)

Auto stop time (if equipped)



This mode displays the elapsed time of Auto stop for "Idle stop and go system".

For more details, refer to the "Idle stop and go system" in chapter 5.

Digital speedometer

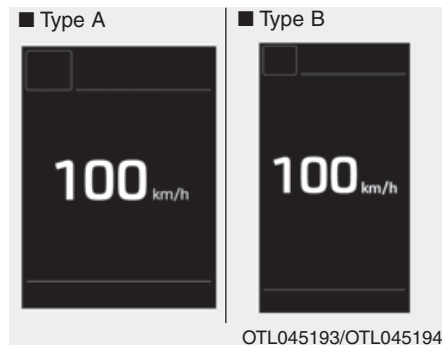

This message shows the speed of the vehicle (km/h, MPH).

Driving Info display

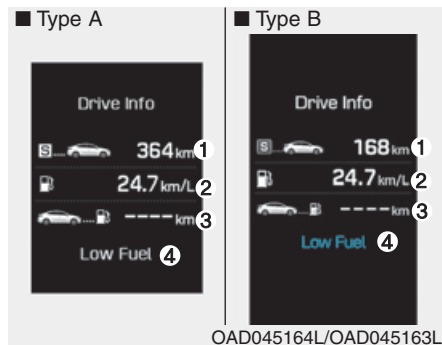

At the end of each driving cycle, the Driving Info message is displayed. This display shows the trip distance (1), the average fuel economy (2), and the remaining distance to empty (3).

This information is displayed for a few seconds when you turn off the ignition, and then goes off automatically. The information is calculated for each ignition cycle.

If the estimated remaining vehicle range is below 1 km (1 mi.), the distance to empty will display as "----" and a "Low Fuel" warning message (4) will be displayed.

i Information

If sunroof open warning is displayed in the cluster, the Driving Info message will not be displayed.

LIGHT

Exterior lights

Lighting control

■ Left-hand drive

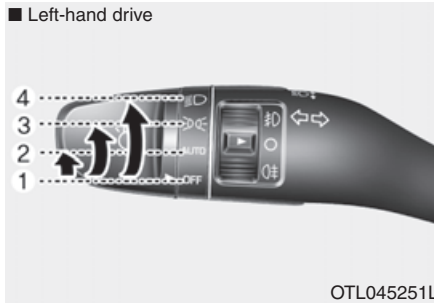

OTL045251L

■ Right-hand drive

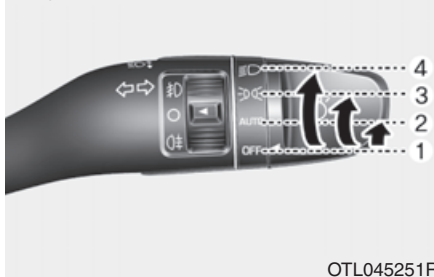

OTL045251R

To operate the lights, turn the knob at the end of the control lever to one of the following positions:

- (1) OFF (O) position
- (2) AUTO light position (if equipped)
- (3) Parking lamp position
- (4) Headlamp position

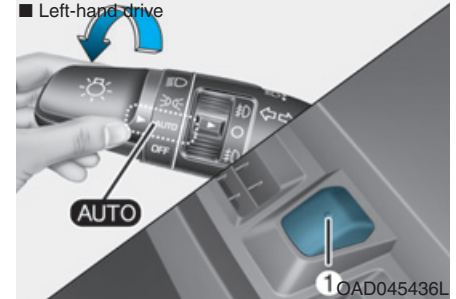

AUTO light position (if equipped)

When the light switch is in the AUTO position, the parking lamp and headlamp will be turned ON or OFF automatically depending on the amount of light outside the vehicle.

Even with the AUTO light feature in operation, it is recommended to manually turn ON the lamps when driving at night or in a fog, or when you enter dark areas, such as tunnels and parking facilities.

NOTICE

- Do not cover or spill anything on the sensor (1) located on the instrument panel.
- Do not clean the sensor using a window cleaner, the cleanser may leave a light film which could interfere with sensor operation.
- If your vehicle has window tint or other types of metallic coating on the front windshield, the AUTO light system may not work properly.

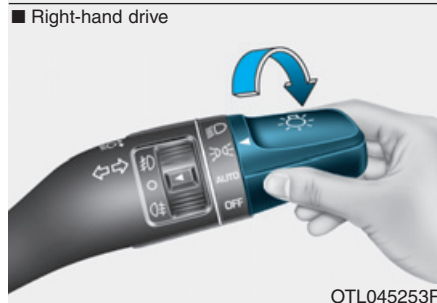

Parking lamp position (☞☞)

The parking lamp, license plate lamp and instrument panel lamp are turned ON.

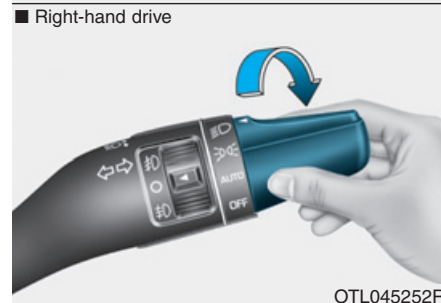

Headlamp position (☞)

The headlamp, parking lamp, license plate lamp and instrument panel lamp are turned ON.

i Information

The ignition switch button must be in the ON position to turn on the headlamp.

High beam operation

■ Left-hand drive

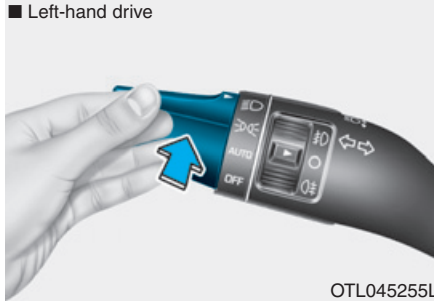

■ Right-hand drive

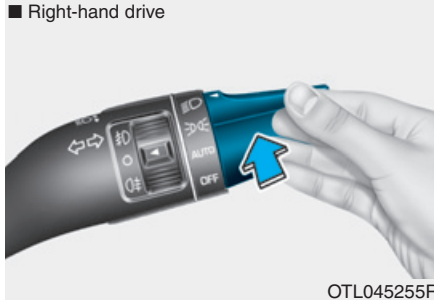

To turn on the high beam headlamp, push the lever away from you. The lever will return to its original position. The high beam indicator will light when the headlamp high beams are switched on.

To turn off the high beam headlamp, pull the lever towards you. The low beams will turn on.

WARNING

Do not use high beam when there are other vehicles approaching you. Using high beam could obstruct the other driver's vision.

■ Left-hand drive



■ Right-hand drive



To flash the high beam headlamp, pull the lever towards you, then release the lever. The high beams will remain ON as long as you hold the lever towards you.

Turn signals and lane change signals

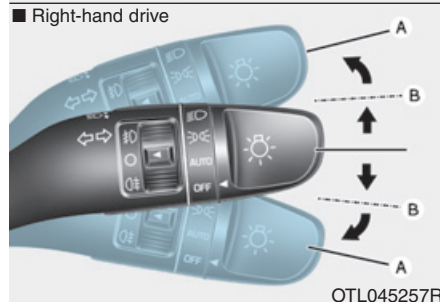
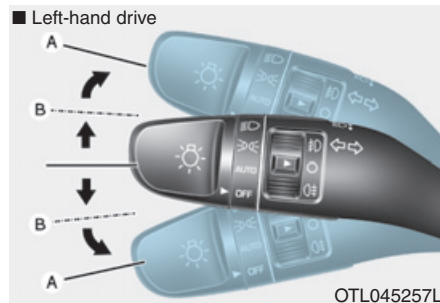

To signal a turn, push down on the lever for a left turn or up for a right turn in position (A). To signal a lane change, move the turn signal lever slightly and hold it in position (B).

The lever will return to the OFF position when released or when the turn is completed.

If an indicator stays on and does not flash or if it flashes abnormally, one of the turn signal bulbs may be burned out and will require replacement.

One-touch turn signal function

To activate an one-touch turn signal function, move the turn signal lever slightly and then release it. The lane change signals will blink 3, 5 or 7 times.

You can activate/deactivate the One Touch Turn Signal function or choose the number of blinking (3, 5, or 7) from the User Settings Mode on the LCD display. **For more details, refer to "LCD Display" in this chapter.**

Front fog lamp (if equipped)

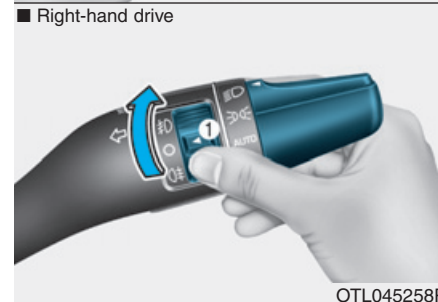

Fog lamps are used to provide improved visibility when visibility is poor due to fog, rain or snow, etc. Use the switch next to the headlamp switch to turn the fog lamps ON and OFF.

1. Turn on the parking lamp.
2. Turn the light switch (1) to the front fog lamp position.
3. To turn off the front fog lamp, turn the light switch to the front fog lamp position again or turn off the parking lamp.

NOTICE

When in operation, the fog lamps consume large amounts of vehicle electrical power. Only use the fog lamps when visibility is poor.

Rear fog lamp (if equipped)

■ Left-hand drive



OTL045278L

■ Right-hand drive



OTL045278R

Vehicle with front fog lamp

To turn on the rear fog lamp:

Position the light switch in the parking lamp position, turn the light switch to the front fog lamp position, and then turn the lamp switch (1) to the rear fog lamp position.

■ Left-hand drive



OTLE045285

■ Right-hand drive

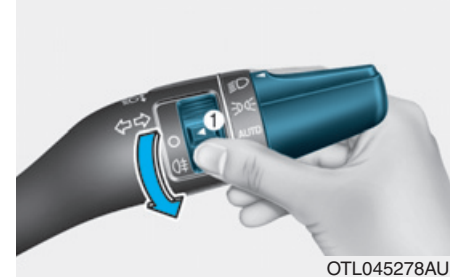

OTL045278AU

Vehicle without front fog lamp

To turn on the rear fog lamp:

Position the light switch in the headlamp position, and then turn the light switch (1) to the rear fog lamp position.

To turn the rear fog lamps off, do one of the following:

- Turn off the headlamp switch.
- Turn the light switch to the rear fog lamp position again.
- When the light switch is in the parking lamp position, if you turn off the front fog lamp, the rear fog lamp will also turn off.

Battery saver function

The purpose of this feature is to prevent the battery from being discharged. The system automatically turns off the parking lamp when the driver turns the engine off and opens the driver-side door.

With this feature, the parking lamps will turn off automatically if the driver parks on the side of road at night.

If necessary, to keep the lamps on when the engine is turned off, perform the following:

- 1) Open the driver-side door.
- 2) Turn the parking lamps OFF and ON again using the light switch on the steering column.

Headlamp delay function (if equipped)

If you place the ignition switch in to the ACC or OFF position with the headlamps ON, the headlamps (and/or parking lamps) remain on for about 5 minutes. However, with the engine off if the driver's door is opened and closed, the headlamps (and/or parking lamps) are turned off after 15 seconds.

The headlamps (and/or parking lamps) can be turned off by pressing the lock button on the smart key twice or turning the light switch to the OFF or AUTO position. However, if you turn the light switch to the AUTO position when it is dark outside, the headlamps will not be turned off.

You can activate or deactivate the Headlamp Delay function from the User Settings Mode on the LCD display. **For more details, refer to "LCD Display" in this chapter.**

NOTICE

If the driver gets out of the vehicle through other doors (except driver's door), the battery saver function does not operate and the headlamp delay function does not turn off automatically. Therefore, it causes the battery to be discharged. In this case, make sure to turn off the lamp before getting out of the vehicle.

Daytime running light (DRL) (if equipped)

The Daytime Running Lights (DRL) can make it easier for others to see the front of your vehicle during the day, especially after dawn and before sunset.

The DRL system will turn the dedicated lamp OFF when:

1. The headlights or front fog lights are in the ON position.
2. The engine is turned off.

Headlight leveling device (if equipped)

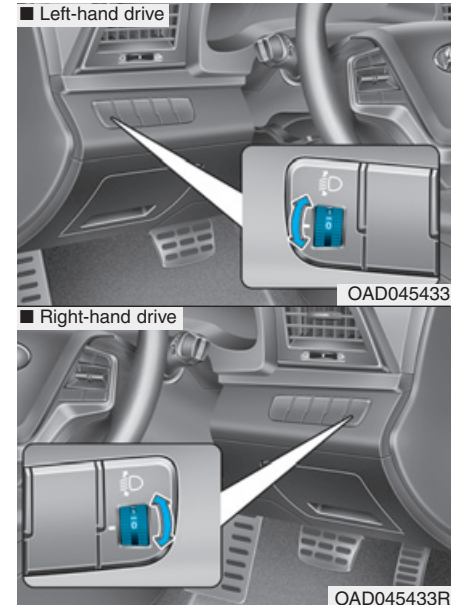

Manual type

To adjust the headlight beam level according to the number of the passengers and loading weight in the luggage area, turn the beam leveling switch.

The higher the number of the switch position, the lower the headlight beam level. Always keep the headlight beam at the proper leveling position, or headlights may dazzle other road users.

Listed below are the examples of proper switch settings. For loading conditions other than those listed below, adjust the switch position so that the beam level may be the nearest as the condition obtained according to the list.

Loading condition	Switch position
Driver only	0
Driver + Front passenger	0
Full passengers (including driver)	1
Full passengers (including driver) + Maximum permissible loading	2
Driver + Maximum permissible loading	3

Welcome system (if equipped)

Welcome light (if equipped)

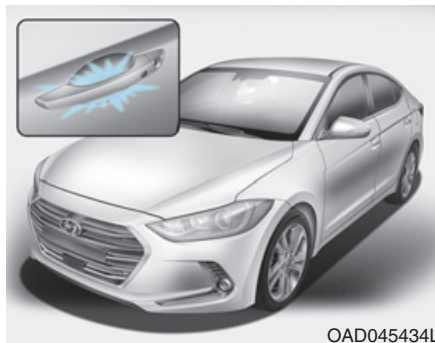

Door handle lamp (if equipped)

When all the doors (and trunk) are closed and locked, the door handle lamp will come on for about 15 seconds if any of the below is performed.

- When the door unlock button is pressed on the remote key or smart key.
- When the button of the outside door handle is pressed.
- When the vehicle is approached with the smart key in possession.

Headlamp and Parking lamp

When the headlamp (lamp switch in the headlamp or AUTO position) is on and all doors (and trunk) are locked and closed, the parking lamp and headlamp will come on for 15 seconds if/or any of the below is performed.

- When the door unlock button is pressed on the remote key or smart key.

At this time, if you press the door lock or unlock button, the parking lamp and headlamp will turn off immediately.

You can activate or deactivate the Welcome Light from the User Settings Mode on the LCD display. **For more details, refer to "LCD Display" in this chapter.**

Interior lamp

When the interior lamp switch is in the DOOR position and all doors (and trunk) are closed and locked, the room lamp will come on for 30 seconds if any of the below is performed.

- When the door unlock button is pressed on the remote key or smart key.
- When the button of the outside door handle is pressed.

At this time, if you press the door lock or unlock button, the room lamp will turn off immediately.

Interior lights

NOTICE

Do not use the interior lights for extended periods when the engine is turned off or the battery will discharge.

⚠ WARNING

If it does not work properly even though your car is inclined backward according to passenger's posture, or the headlight beam is irradiated to the high or low position, we recommend that the system be inspected by an authorized HYUNDAI dealer.

Do not attempt to inspect or replace the wiring yourself.

Interior lamp AUTO cut

The interior lamps will automatically go off approximately 20 minutes after the engine is turned off and the doors closed. If a door is opened, the lamp will go off 40 minutes after the engine is turned off. If the doors are locked by the smart key and the vehicle enters the armed stage of the theft alarm system, the lamps will go off five seconds later.

Front lamps

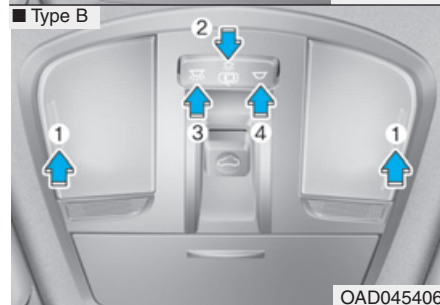
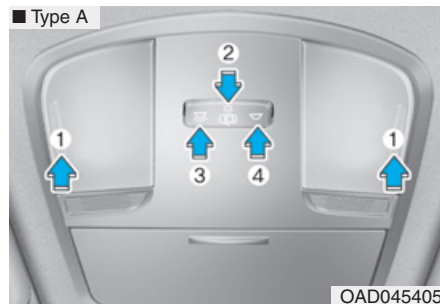

- (1) Front Room Lamp
- (2) Front Door Lamp
- (3) Front Map Lamp



Front Map Lamp :

Press either of these lens to turn the map lamp on or off. This light produces a spot beam for convenient use as a map lamp at night or as a personal lamp for the driver and the front passenger.

Front Door Lamp ():

The front or rear room lamps come on when the front or rear doors are opened if the engine is running or not. When doors are unlocked by the remote key or smart key, the front and rear lamps come on for approximately 30 seconds as long as any door is not opened. The front and rear room lamps go out gradually after approximately 30 seconds if the door is closed. However, if the ignition switch is in the ON position or all doors are locked, the front and rear lamps will turn off. If a door is opened with the ignition switch in the ACC position or the OFF position, the front and rear lamps stay on for about 20 minutes.

Front room lamp

-  :
Press the button to turn ON the room lamp for the front/rear seats. Re-press the button to turn OFF the room lamp.
-  :
Press the button to turn OFF the room lamp for the front/rear seats.

Rear lamps



Rear Room Lamp Switch ():

Press this button to turn the room lamp on and off.

NOTICE

Do not leave the lamp switches on for an extended period of time when the engine is turned off.

Trunk room lamp

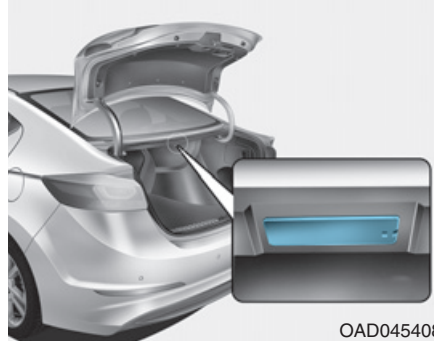

The trunk lamp comes on when the trunk is opened.



NOTICE

The trunk lamp comes on as long as the trunk lid is open. To prevent unnecessary charging system drain, close the trunk lid securely after using the trunk.

Vanity mirror lamp



Push the switch to turn the light on or off.

-  : The lamp will turn on if this button is pressed.
-  : The lamp will turn off if this button is pressed.

NOTICE

Always have the switch in the off position when the vanity mirror lamp is not in use. If the sunvisor is closed without the lamp off, it may discharge the battery or damage the sunvisor.

WIPERS AND WASHERS

■ Left-hand drive

• Type A

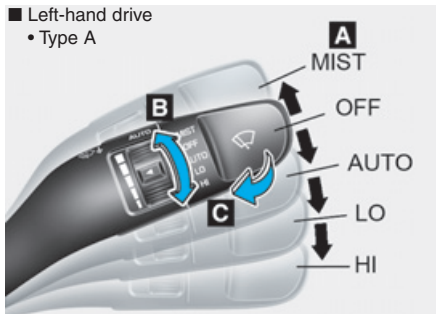

OAD045437L

• Type B

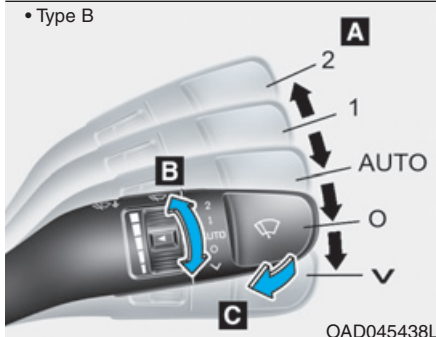

OAD045438L

■ Right-hand drive

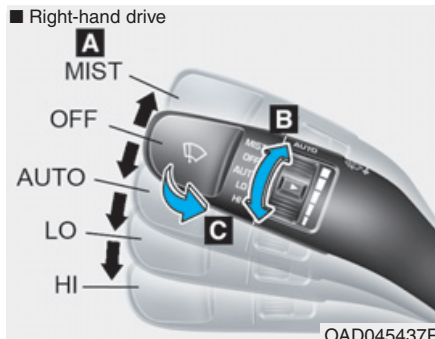

OAD045437R

A : Wiper speed control

- MIST / ∇ – Single wipe
- O / OFF – Off
- --- / INT – Intermittent wipe
- AUTO* – Auto control wipe
- 1 / LO – Low wiper speed
- 2 / HI – High wiper speed

* : if equipped

B : Auto control wipe time adjustment

C : Wash with brief wipes

Windshield wipers

Operates as follows when the ignition switch is in the ON position.

MIST (V) : For a single wiping cycle, push the lever upward and release. The wipers will operate continuously if the lever is held in this position.

OFF (O) : Wiper is not in operation.

INT (---) : Wiper operates intermittently at the same wiping intervals. To vary the speed setting, turn the speed control knob (B).

AUTO : The rain sensor located on the upper end of the windshield glass senses the amount of rainfall and controls the wiping cycle for the proper interval. The more it rains, the faster the wiper operates. When the rain stops, the wiper stops. To vary the speed setting, turn the speed control knob (B).

LO (1) : The wiper runs at a lower speed.

HI (2) : The wiper runs at a higher speed.

i Information

If there is heavy accumulation of snow or ice on the windshield, defrost the windshield for about 10 minutes, or until the snow and/or ice is removed before using the windshield wipers to ensure proper operation.

If you do not remove the snow and/or ice before using the wiper and washer, it may damage the wiper and washer system.

AUTO (Automatic) control (if equipped)

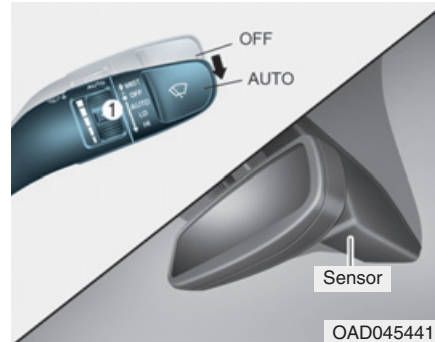

The rain sensor located on the upper end of the windshield glass senses the amount of rainfall and controls the wiping cycle for the proper interval. The more it rains, the faster the wiper operates.

When the rain stops, the wiper stops. To vary the speed setting, turn the speed control knob (1).

If the wiper switch is set in AUTO mode when the ignition switch is in the ON position, the wiper will operate once to perform a self-check of the system. Set the wiper to OFF position when the wiper is not in use.

⚠ WARNING

To avoid personal injury from the windshield wipers, when the engine is running and the windshield wiper switch is placed in the AUTO mode:

- Do not touch the upper end of the windshield glass facing the rain sensor.
- Do not wipe the upper end of the windshield glass with a damp or wet cloth.
- Do not put pressure on the windshield glass.

NOTICE

- When washing the vehicle, set the wiper switch in the OFF (O) position to stop the auto wiper operation. The wiper may operate and be damaged if the switch is set in the AUTO mode while washing the vehicle.
- Do not remove the sensor cover located on the upper end of the passenger side windshield glass. Damage to system parts could occur and may not be covered by your vehicle warranty.

Windshield washers

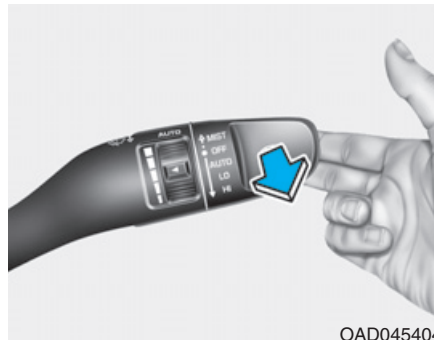

In the OFF (O) position, pull the lever gently toward you to spray washer fluid on the windshield and to run the wipers 1-3 cycles. The spray and wiper operation will continue until you release the lever. If the washer does not work, you may need to add washer fluid to the washer fluid reservoir.

If equipped with the Headlamp Washer, washer fluid will be sprayed on the headlamp at the same time you operate the windshield washer when:

1. The ignition switch is in the ON position.
2. The light switch is in the headlamp position.

WARNING

When the outside temperature is below freezing, ALWAYS warm the windshield using the defroster to prevent the washer fluid from freezing on the windshield and obscuring your vision which could result in an accident and serious injury or death.



CAUTION

- To prevent possible damage to the washer pump, do not operate the washer when the fluid reservoir is empty.
- To prevent possible damage to the wipers or windshield, do not operate the wipers when the windshield is dry.
- To prevent damage to the wiper arms and other components, do not attempt to move the wipers manually.
- To prevent possible damage to the wipers and washer system, use anti-freezing washer fluids in the winter season or cold weather.

DRIVER ASSIST SYSTEM

Rear view camera (if equipped)

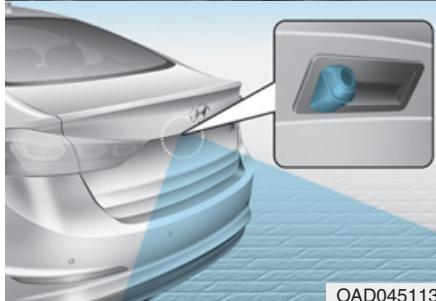
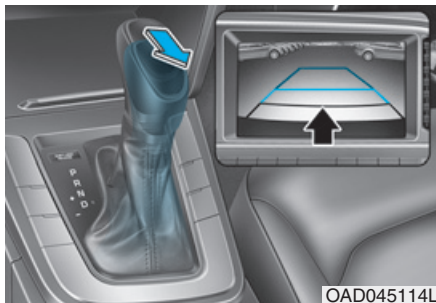

The Rear View Camera will activate when the engine is running and the shift lever is in the R (Reverse) position.

This is a supplemental system that provides a view of the area behind the vehicle through the A/V display while the vehicle is in the R (Reverse) position.

WARNING

The rear camera display is not a safety device. It only serves to assist the driver in identifying objects directly behind the middle of the vehicle. The camera does NOT cover the complete area behind the vehicle.

WARNING

- Never rely solely on the rear camera display when backing-up.
- **ALWAYS** look around your vehicle to make sure there are no objects or obstacles before moving the vehicle in any direction to prevent a collision.
- Always pay close attention when the vehicle is driven close to objects, particularly pedestrians, and especially children.

CAUTION

Do not use any cleanser containing acid or alkaline detergents when cleaning the lens. Use only a mild soap or neutral detergent, and rinse thoroughly with water.

Information

Always keep the camera lens clean. The camera may not work normally if the lens is covered with dirt or snow.

Rear parking assist system (if equipped)

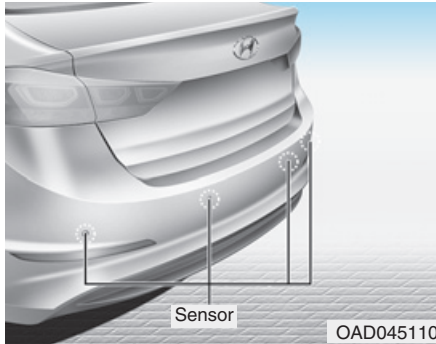

The Rear Parking Assist System assists the driver during reverse movement of the vehicle by chiming if any object is sensed within approximately 120 cm (50 in) behind the vehicle.

This system is a supplemental system that senses objects within the range and location of the sensors, it cannot detect objects in other areas where sensors are not installed.

WARNING



- **ALWAYS** look around your vehicle to make sure there are not any objects or obstacles before moving the vehicle in any direction to prevent a collision.
- **Always** pay close attention when the vehicle is driven close to objects, particularly pedestrians, and especially children.
- **Be aware that some objects may not be visible on the screen or be detected by the sensors, due to the objects distance, size or material, all of which can limit the effectiveness of the sensor.**

Operation of the Rear Parking Assist System

Operating condition

- This system will activate when backing up with the ignition switch in the ON position. However, if the vehicle speed exceeds 5 km/h (3 mph), the system may not detect objects.
- If the vehicle speed exceeds 10 km/h (6 mph), the system will not warn you even though objects are detected.
- When more than two objects are sensed at the same time, the closest one will be recognized first.

Types of warning sound and indicator

Types of warning sound	Indicator
When an object is approximately 60 to 120 cm (24 to 47 in) from the rear bumper, the warning sound beeps intermittently.	
When an object is approximately 30 to 60 cm (12 to 24 in) from the rear bumper, the warning sound beeps more frequently.	
When an object is within approximately 30 cm (12 in) from the rear bumper, the warning sound beeps continuously.	

NOTICE

- The indicator may differ from the illustration as objects or sensors status. If the indicator blinks, we recommend that you have your vehicle checked by an authorized HYUNDAI dealer.
- If the audible warning does not sound or if the buzzer sounds intermittently when shifting into R (Reverse) position, this may indicate a malfunction with the Parking Assist System. If this occurs, we recommend that you have your vehicle checked by an authorized HYUNDAI dealer as soon as possible.

Non-operational conditions of Parking Assist System

The Rear Parking Assist System may not operate normally when:

- Moisture is frozen to the sensor.
- The sensor is covered with dirt or debris such as snow or ice, or the sensor cover is blocked.

There is a possibility of the Rear Parking Assist System malfunction when:

- Driving on uneven road surfaces such as unpaved roads, gravel, bumps, or gradient.
- Objects generating excessive noise such as vehicle horns, loud motorcycle engines, or truck air brakes can interfere with the sensor.
- Heavy rain or water spray is present.
- Wireless transmitters or mobile phones are present near the sensor.
- The sensor is covered with snow.
- Any non-factory equipment or accessories have been installed, or if the vehicle bumper height or sensor installation has been modified.

Detecting range may decrease when:

- Outside air temperature is extremely hot or cold.
- Undetectable objects smaller than 1 m (40 inches) and narrower than 14 cm (6 inches) in diameter.

The following objects may not be recognized by the sensor:

- Sharp or slim objects such as ropes, chains or small poles.
- Objects, which tend to absorb sensor frequency such as clothes, spongy material or snow.

Rear parking assist system precautions

- The rear parking assist system may not operate consistently in some circumstances depending on the speed of the vehicle and the shapes of the objects detected.
- The rear parking assist system may malfunction if the vehicle bumper height or sensor installation has been modified or damaged. Any non-factory installed equipment or accessories may also interfere with the sensor performance.
- The sensor may not recognize objects less than 40 cm (15 in) from the sensor, or it may sense an incorrect distance. Use caution.
- When the sensor is blocked with snow, dirt, debris, or ice, the rear parking assist system may be inoperative until the snow or ice melts, or the debris is removed. Use a soft cloth to wipe debris away from the sensor.
- Do not push, scratch or strike the sensor with any hard objects that could damage the surface of the sensor. Sensor damage could occur.

- Do not spray the sensors or its surrounding area directly with a high pressure washer. Doing so may cause the sensors to fail to operate normally.

 **WARNING**

Your new vehicle warranty does not cover any accidents or damage to the vehicle or injuries to its occupants related to a Rear Parking Assist System. Always drive safely and cautiously.

Parking Assist System (if equipped)

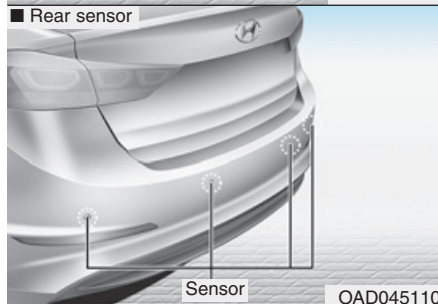
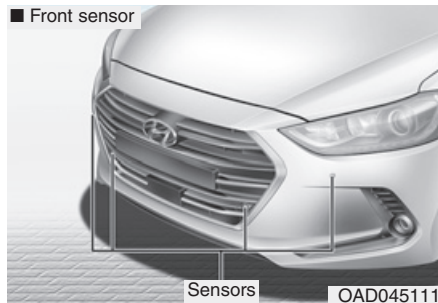

The Parking Assist System assists the driver during movement of the vehicle by chiming if any object is sensed within approximately 100 cm (40 in) in front and 120 cm (47 in) behind the vehicle.

This system is a supplemental system that senses objects within the range and location of the sensors, it cannot detect objects in other areas where sensors are not installed.

WARNING

- **ALWAYS** look around your vehicle to make sure there are not any objects or obstacles before moving the vehicle in any direction to prevent a collision.
- Always pay close attention when the vehicle is driven close to objects, particularly pedestrians, and especially children.
- Be aware that some objects may not be visible on the screen or be detected by the sensors, due to the objects distance, size or material, all of which can limit the effectiveness of the sensor.

Operation of the Parking Assist System

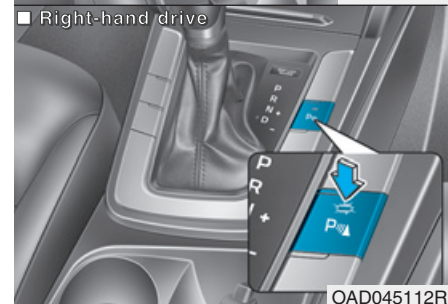
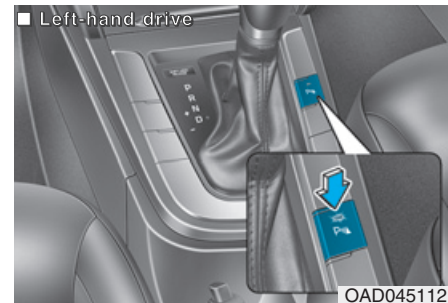







Operating condition

- This system will activate when the Parking Assist System button is pressed with the engine running.

- The Parking Assist System button turns on automatically and activates the Parking Assist System when you move the shift lever to the R (Reverse) position. However, if the vehicle speed exceeds 10 km/h (6 mph), the system will not warn you even though objects are detected, and if the vehicle speed exceeds 20 km/h (12 mph), the system will turn off automatically. To turn on the system, press the Parking Assist System button.
- When more than two objects are sensed at the same time, the closest one will be recognized first.

Types of warning sound and indicator

Distance from object		Warning indicator		Warning sound
		When driving forward	When driving rearward	
100cm~61cm	Front		-	Buzzer beeps intermittently
120cm~61cm	Rear	-		Buzzer beeps intermittently
60cm~31cm	Front			Buzzer beeps frequently
	Rear	-		Buzzer beeps frequently
30cm	Front			Buzzer sounds continuously
	Rear	-		Buzzer sounds continuously

NOTICE

- The indicator may differ from the illustration as objects or sensors status. If the indicator blinks, we recommend that the system be checked by an authorized HYUNDAI dealer.
- If the audible warning does not sound or if the buzzer sounds intermittently when shifting into R (Reverse) position, this may indicate a malfunction with the Parking Assist System. If this occurs, we recommend that you have your vehicle checked by an authorized HYUNDAI dealer as soon as possible.

Non-operational conditions of Parking Assist System

Parking Assist System may not operate normally when:

- Moisture is frozen to the sensor.
- The sensor is covered with dirt or debris such as snow or ice, or the sensor cover is blocked.

There is a possibility of Parking Assist System malfunction when:

- Driving on uneven road surfaces such as unpaved roads, gravel, bumps, or gradient.
- Objects generating excessive noise such as vehicle horns, loud motorcycle engines, or truck air brakes can interfere with the sensor.
- Heavy rain or water spray is present.
- Wireless transmitters or mobile phones are present near the sensor.
- The sensor is covered with snow.
- Any non-factory equipment or accessories have been installed, or if the vehicle bumper height or sensor installation has been modified.

Detecting range may decrease when:

- Outside air temperature is extremely hot or cold.
- Undetectable objects smaller than 1 m and narrower than 14 cm in diameter.

The following objects may not be recognized by the sensor:

- Sharp or slim objects such as ropes, chains or small poles.
- Objects, which tend to absorb sensor frequency such as clothes, spongy material or snow.

Parking assist system precautions

- The parking assist system may not operate consistently in some circumstances depending on the speed of the vehicle and the shapes of the objects detected.
 - The parking assist system may malfunction if the vehicle bumper height or sensor installation has been modified or damaged. Any non-factory installed equipment or accessories may also interfere with the sensor performance.
 - The sensor may not recognize objects less than 40 cm (15 in) from the sensor, or it may sense an incorrect distance. Use caution.
 - When the sensor is blocked with snow, dirt, debris, or ice, the parking assist system may be inoperative until the snow or ice melts, or the debris is removed. Use a soft cloth to wipe debris away from the sensor.
 - Do not push, scratch or strike the sensor with any hard objects that could damage the surface of the sensor. Sensor damage could occur.
- Do not spray the sensors or its surrounding area directly with a high pressure washer. Doing so may cause the sensors to fail to operate normally.

WARNING

Your new vehicle warranty does not cover any accidents or damage to the vehicle or injuries to its occupants related to a Parking Assist System. Always drive safely and cautiously.

DEFROSTER

NOTICE

To prevent damage to the conductors bonded to the inside surface of the rear window, never use sharp instruments or window cleaners containing abrasives to clean the window.

i Information

If you want to defrost and defog the front windshield, refer to “Windshield Defrosting and Defogging” in this chapter.

Rear window defroster

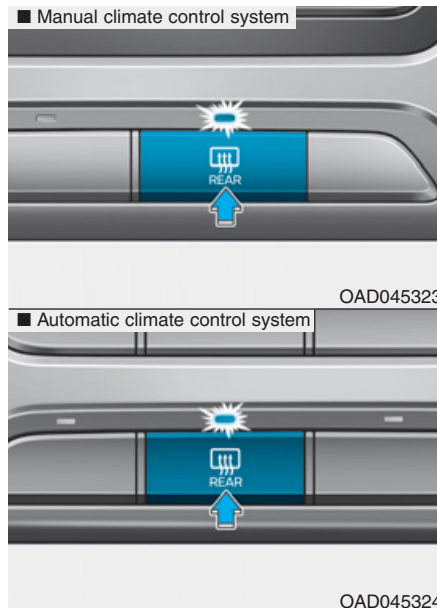

The defroster heats the window to remove frost, fog and thin ice from the interior and exterior of the rear window, while engine is running.

- To activate the rear window defroster, press the rear window defroster button located in the center facia switch panel. The indicator on the rear window defroster button illuminates when the defroster is ON.
- To turn off the defroster, press the rear window defroster button again.

i Information

- If there is heavy accumulation of snow on the rear window, brush it off before operating the rear defroster.
- The rear window defroster automatically turns off after approximately 20 minutes or when the Engine Start/Stop button is in the OFF position.

Outside mirror defroster (if equipped)

If your vehicle is equipped with the outside mirror defrosters, they will operate at the same time you turn on the rear window defroster.

MANUAL CLIMATE CONTROL SYSTEM (IF EQUIPPED)





1. Fan speed control knob
2. Temperature control knob
3. Mode selection buttons
4. Front windshield defroster button
5. Rear window defroster button
6. A/C (Air conditioning) button
7. Air intake control button

NOTICE

Operating the blower when the Engine Start/Stop button is in the ON position could cause the battery to discharge. Operate the blower when the engine is running.

Heating and air conditioning

1. Start the engine.
2. Set the mode to the desired position.
To improve the effectiveness of heating and cooling :
 - Heating: 
 - Cooling: 
3. Set the temperature control to the desired position.
4. Set the air intake control to the outside (fresh) air position.
5. Set the fan speed control to the desired speed.
6. If air conditioning is desired, turn the air conditioning system on.

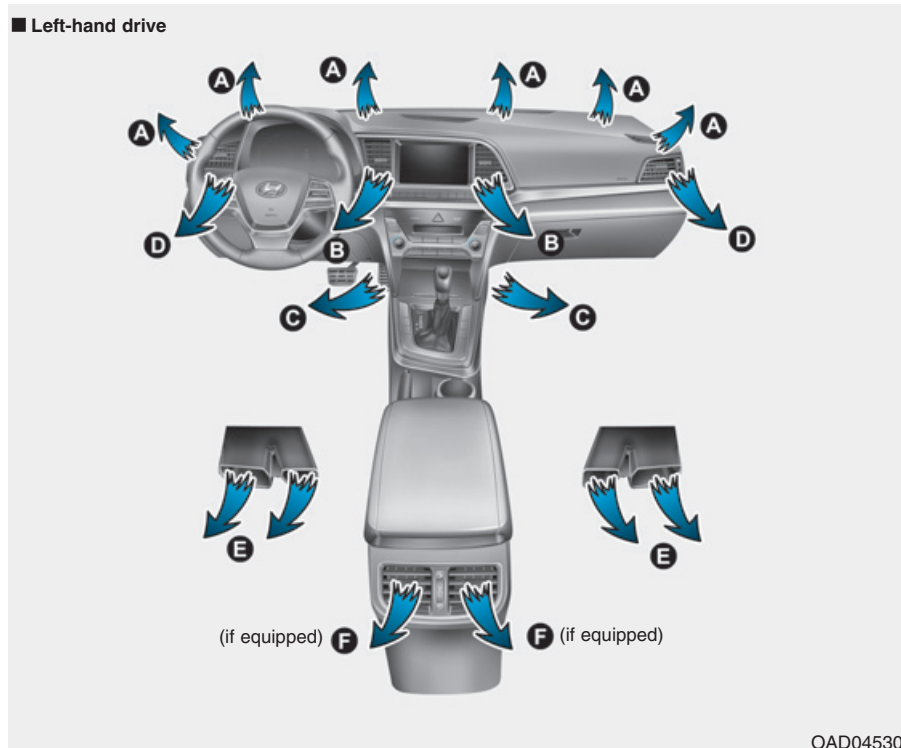

■ Right-hand drive

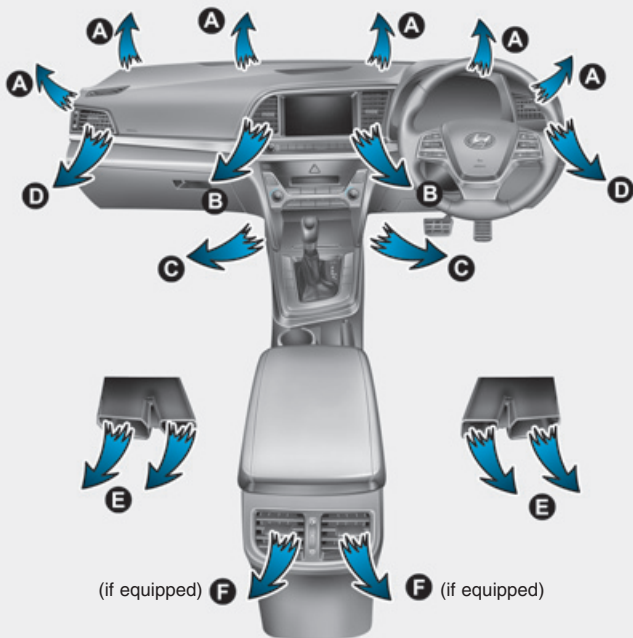

OAD045302R

Mode selection

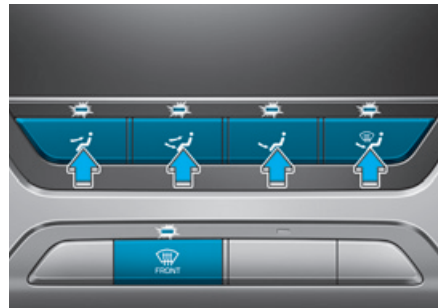

OAD045301

The mode selection button controls the direction of the air flow through the ventilation system.

Air can be directed to the floor, dashboard outlets, or windshield. Five symbols are used to represent Face, Bi-Level, Floor, Floor-Defrost and Defrost air position.



Face-Level (B, D, F)

Air flow is directed toward the upper body and face. Additionally, each outlet can be controlled to direct the air discharged from the outlet.



Bi-Level (B, D, C, E, F)

Air flow is directed towards the face and the floor.



Floor-Level (C, E, A, D)

Most of the air flow is directed to the floor, with a small amount of the air being directed to the windshield and side window defrosters.



Floor/Defrost-Level (A, C, E, D)

Most of the air flow is directed to the floor and the windshield with a small amount directed to the side window defrosters.



Defrost-Level (A, D)

Most of the air flow is directed to the windshield with a small amount of air directed to the side window defrosters.

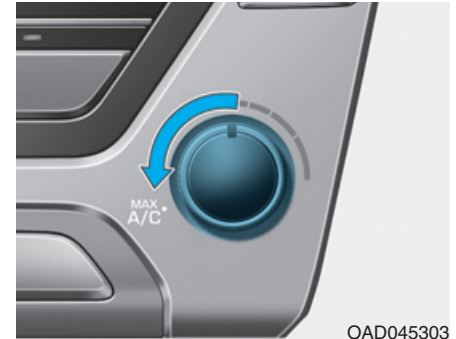

MAX A/C-Level (B, D, F)

To operate the MAX A/C, turn the temperature selection knob to extreme left. Air flow is directed toward the upper body and face.

In this mode, the air conditioning and the recirculated air position will be selected automatically.

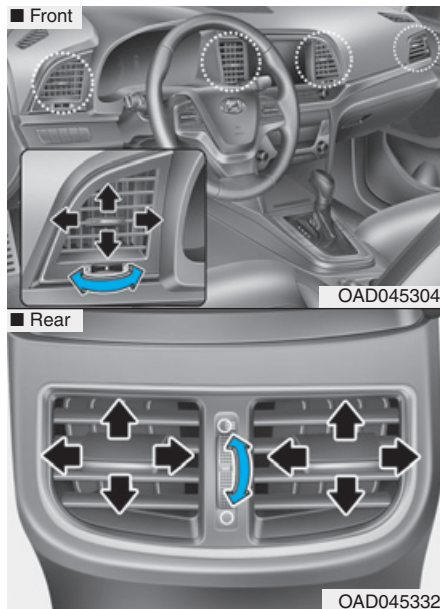

Instrument panel vents

The outlet vents can be opened or closed separately using the thumb-wheel.

Also, you can adjust the direction of air delivery from these vents using the vent control lever as shown.

Temperature control



The temperature control knob allows you to control the temperature of the air flowing from the ventilation system. To change the air temperature in the passenger compartment, turn the knob to the right position for warm and hot air or left position for cooler air.

Air intake control



This is used to select outside (fresh) air position or recirculated air position. To change the air intake control position, press the control button.

Recirculated air position



With the recirculated air position selected, air from the passenger compartment will be drawn through the heating system and heated or cooled according to the function selected.

Outside (fresh) air position



With the outside (fresh) air position selected, air enters the vehicle from outside and is heated or cooled according to the function selected.

i Information

It should be noted that prolonged operation of the heater in the recirculated air position (without air conditioning selected) will cause fogging of the windshield and side windows and the air within the passenger compartment will become stale.

In addition, prolonged use of the air conditioning with the recirculated air position selected will result in excessively dry air in the passenger compartment.

! WARNING

- Continuous operation of the climate control system in the recirculated air position may allow humidity to increase inside the vehicle which may fog the glass and obscure visibility.
- Do not sleep in a vehicle with air conditioning or heating system on. It may cause serious harm or death due to a drop in the oxygen level and/or body temperature.
- Continuous operation of the climate control system in the recirculated air position can cause drowsiness or sleepiness, and loss of vehicle control. Set the air intake control to the outside (fresh) air position as much as possible while driving.

Fan speed control



OAD045308

The ignition switch must be in the ON position for fan operation.

The fan speed control knob allows you to control the fan speed of the air flowing from the ventilation system. To change the fan speed, turn the knob to the right for higher speed or left for lower speed.

Setting the fan speed control knob to the “0” position turns off the fan.

Air conditioning (A/C)



OAD045309

Press the A/C button to turn the air conditioning system on (indicator light will illuminate). Press the button again to turn the air conditioning system off.



System operation

Ventilation

1. Set the mode to the  position.
2. Set the air intake control to the outside (fresh) air position.
3. Set the temperature control to the desired position.
4. Set the fan speed control to the desired speed.

Heating

1. Set the mode to the  position.
2. Set the air intake control to the outside (fresh) air position.
3. Set the temperature control to the desired position.
4. Set the fan speed control to the desired speed.
5. If dehumidified heating is desired, turn the air conditioning system (if equipped) on.

If the windshield fogs up, set the mode to the  or  position.

Operation Tips

- To keep dust or unpleasant fumes from entering the car through the ventilation system, temporarily set the air intake control to the recirculated air position. Be sure to return the control to the fresh air position when the irritation has passed to keep fresh air in the vehicle. This will help keep the driver alert and comfortable.
- Air for the heating/cooling system is drawn in through the grilles just ahead of the windshield. Care should be taken that these are not blocked by leaves, snow, ice or other obstructions.
- To prevent interior fog on the windshield, set the air intake control to the fresh air position and fan speed to the desired position, turn on the air conditioning system, and adjust the temperature control to desired temperature.

Air conditioning

HYUNDAI Air Conditioning Systems are filled with R-134a or R1234yf refrigerant.

1. Start the engine. Push the air conditioning button.
2. Set the mode to the  position.
3. Set the air intake control to the outside air or recirculated air position.
4. Adjust the fan speed control and temperature control to maintain maximum comfort.

Information

Your vehicle is filled with R-134a or R-1234yf according to the regulation in your country at the time of production. You can find out which air conditioning refrigerant is applied to your vehicle on the label located inside of the hood.

NOTICE

- The refrigerant system should only be serviced by trained and certified technicians to insure proper and safe operation.
- The refrigerant system should be serviced in a well-ventilated place.
- The air conditioning evaporator (cooling coil) shall never be repaired or replaced with one removed from a used or salvaged vehicle and new replacement MAC evaporators shall be certified (and labeled) as meeting SAE Standard J2842.

i Information

- When using the air conditioning system, monitor the temperature gauge closely while driving up hills or in heavy traffic when outside temperatures are high. Air conditioning system operation may cause engine overheating. Continue to use the blower fan but turn the air conditioning system off if the temperature gauge indicates engine overheating.
- When opening the windows in humid weather air conditioning may create water droplets inside the vehicle. Since excessive water droplets may cause damage to electrical equipment, air conditioning should only be used with the windows closed.

Air conditioning system operation tips

- If the vehicle has been parked in direct sunlight during hot weather, open the windows for a short time to let the hot air inside the vehicle escape.
 - To help reduce moisture inside of the windows on rainy or humid days, decrease the humidity inside the vehicle by operating the air conditioning system.
 - During air conditioning system operation, you may occasionally notice a slight change in engine speed as the air conditioning compressor cycles. This is a normal system operation characteristic.
 - Use the air conditioning system every month only for a few minutes to ensure maximum system performance.
 - When using the air conditioning system, you may notice clear water dripping (or even puddling) on the ground under the passenger side of the vehicle. This is a normal system operation characteristic.
- Operating the air conditioning system in the recirculated air position provides maximum cooling, however, continual operation in this mode may cause the air inside the vehicle to become stale.
 - During cooling operation, you may occasionally notice a misty air flow because of rapid cooling and humid air intake. This is a normal system operation characteristic.

System maintenance

Climate control air filter

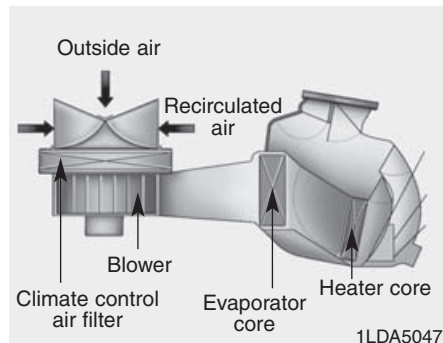

The climate control air filter installed behind the glove box filters the dust or other pollutants that come into the vehicle from the outside through the heating and air conditioning system. If dust or other pollutants accumulate in the filter over a period of time, the air flow from the air vents may decrease, resulting in moisture accumulation on the inside of the windshield even when the outside (fresh) air position is selected. If this happens, we recommend that the climate control air filter be replaced by an authorized HYUNDAI dealer.

i Information

- Replace the filter according to the Maintenance Schedule.

If the car is being driven in severe conditions such as dusty, rough roads, more frequent climate control air filter inspections and changes are required.

- When the air flow rate suddenly decreases, we recommend that the system be checked by an authorized HYUNDAI dealer.

i Information

It is important that the correct type and amount of oil and refrigerant is used. Otherwise, damage to the compressor and abnormal system operation may occur.

! WARNING

We recommend that the air conditioning system be serviced by an authorized HYUNDAI dealer.

Improper service may cause serious injury to the person performing the service.

Air Conditioning refrigerant label

■ Example

• Type A

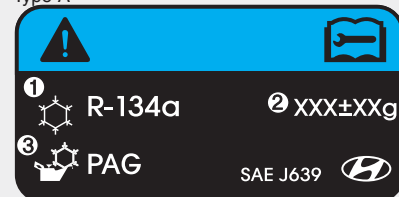

ODH044365R

• Type B



ODH043366

The actual Air Conditioning refrigerant label in the vehicle may differ from the illustration.

Each symbols and specification on air conditioning refrigerant label means as below :

1. Classification of refrigerant
2. Amount of refrigerant
3. Classification of Compressor lubricant

You can find out which air conditioning refrigerant is applied to your vehicle on the label located inside of the hood.

Checking the amount of air conditioner refrigerant and compressor lubricant

When the amount of refrigerant is low, the performance of the air conditioning is reduced. Overfilling also has a bad influence on the air conditioning system.

Therefore, if abnormal operation is found, we recommend that the system be inspected by an authorized HYUNDAI dealer.

⚠ WARNING

Vehicles equipped with R-134a



Because the refrigerant is at very high pressure, the air conditioning system should only be serviced by trained and certified technicians. It is important that the correct type and amount of oil and refrigerant is used.

Otherwise, it may cause damage to the vehicle and personal injury.

⚠ WARNING

Vehicles equipped with R-1234yf



Because the refrigerant is mildly inflammable at very high pressure, the air conditioning system should only be serviced by trained and certified technicians.

It is important that the correct type and amount of oil and refrigerant is used.

Otherwise, it may cause damage to the vehicle and personal injury.

AUTOMATIC CLIMATE CONTROL SYSTEM (IF EQUIPPED)



1. Driver's temperature control knob
2. Passenger's temperature control knob
3. AUTO (automatic control) button
4. SYNC button
5. OFF button
6. Fan speed control button
7. Mode selection button
8. Air conditioning button
9. Front windshield defrost button
10. Air intake control button
11. Rear window defrost button
12. Climate control information screen

NOTICE

Operating the blower when the ignition switch is in the ON position could cause the battery to discharge. Operate the blower when the engine is running.

OAD045310

Automatic heating and air conditioning



1. Press the AUTO button.

The modes, fan speeds, air intake and air-conditioning will be controlled automatically according to the temperature setting.

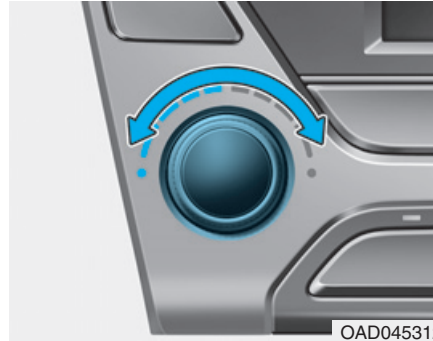

2. Turn the temperature control knob to set the desired temperature.

i Information

- To turn the automatic operation off, select any button of the following:
 - Mode selection button
 - Front windshield defrost button (Press the button one more time to deselect the front windshield defroster function. The 'AUTO' sign will illuminate on the information display once again.)
 - Fan speed control button
- The selected function will be controlled manually while other functions operate automatically.
- For your convenience, use the AUTO button and set the temperature to 23°C (73°F).

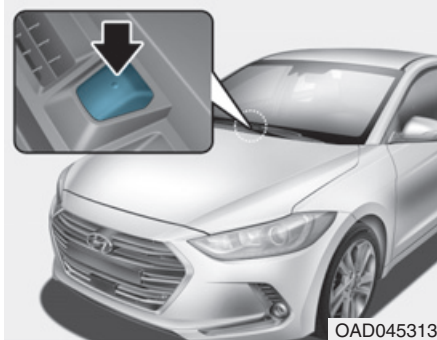



i Information

Never place anything near the sensor to ensure better control of the heating and cooling system.

Manual heating and air conditioning

The heating and cooling system can be controlled manually by pushing buttons other than the AUTO button. In this case, the system works sequentially according to the order of buttons selected. When pressing any button except the AUTO button while using automatic operation, the functions not selected will be controlled automatically.

1. Start the engine.
2. Set the mode to the desired position.
For improving the effectiveness of heating and cooling;
 - Heating: 
 - Cooling: 
3. Set the temperature control to the desired position.

4. Set the air intake control to the outside (fresh) air position.
5. Set the fan speed control to the desired speed.
6. If air conditioning is desired, turn the air conditioning system on.
Press the AUTO button in order to convert to full automatic control of the system.

■ Left-hand drive

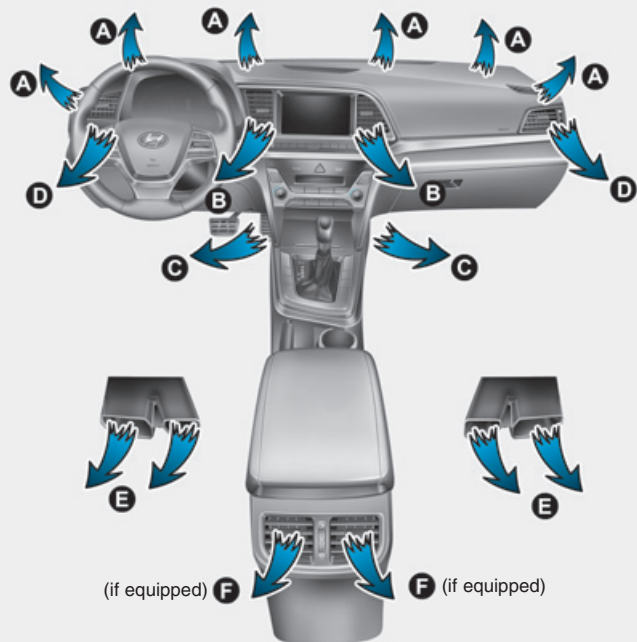

OAD045302

■ Right-hand drive

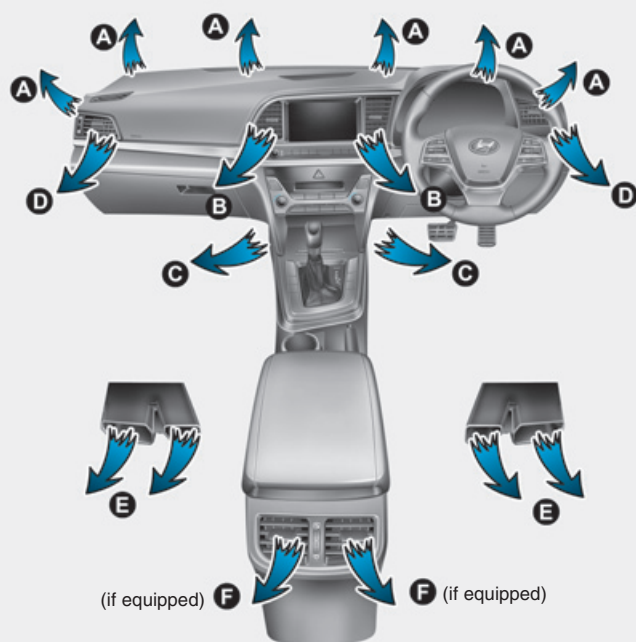

OAD045302R

Mode selection



The mode selection button controls the direction of the air flow through the ventilation system.

The air flow outlet port is converted as follows:



Face-Level (B, D, F)

Air flow is directed toward the upper body and face. Additionally, each outlet can be controlled to direct the air discharged from the outlet.



Bi-Level (B, C, D, E, F)

Air flow is directed towards the face and the floor.



Floor & Defrost (A, C, D, E)

Most of the air flow is directed to the floor and the windshield with a small amount directed to the side window defrosters.



Floor-Level (A, C, D, E)

Most of the air flow is directed to the floor, with a small amount of the air being directed to the windshield and side window defrosters.

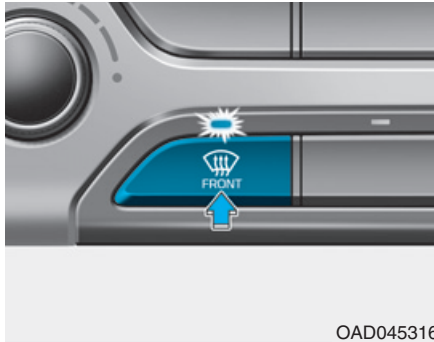

OAD045316

Defrost-Level (A)

Most of the air flow is directed to the windshield with a small amount of air directed to the side window defrosters.

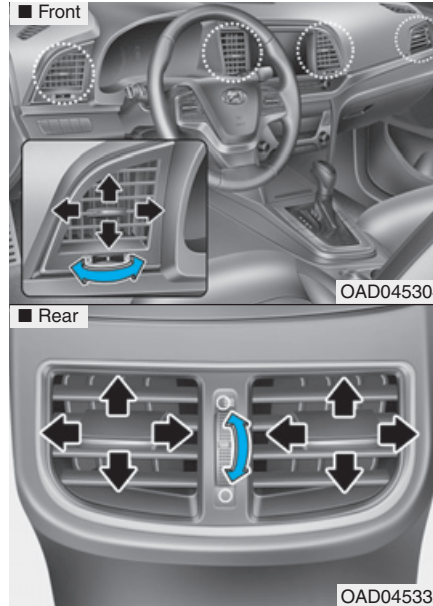

OAD045304

OAD045332

Instrument panel vents

The outlet vents can be opened or closed separately using the thumb-wheel. To close the vent, rotate it left (Rear : down) to the maximum position. To open the vent, rotate it right (Rear : up) to the desired position.

Also, you can adjust the direction of air delivery from these vents using the vent control lever as shown.

Temperature control

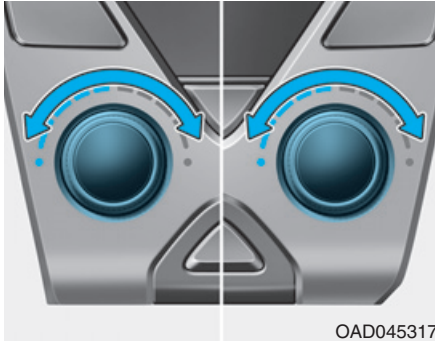

Turn the temperature control knob to set the desired temperature.

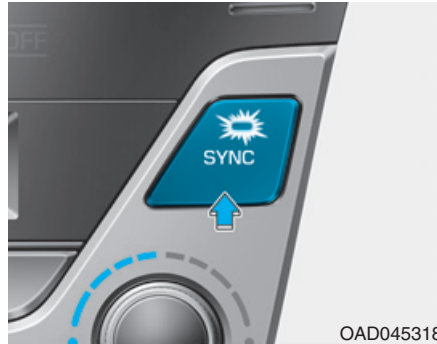

Adjusting the driver and passenger side temperature equally

- Press the “SYNC” button to adjust the driver and passenger side temperature equally.

The passenger side temperature will be set to the same temperature as the driver side temperature.

- Turn the driver side temperature control knob. The driver and passenger side temperature will be adjusted equally.

Adjusting the driver and passenger side temperature individually

- Press the “SYNC” button again to adjust the driver and passenger side temperature individually. The illumination of button turns off.
- Operate the driver side temperature control knob to adjust the driver side temperature.
- Operate the passenger side temperature control knob to adjust the passenger side temperature.

Temperature conversion

If the battery has been discharged or disconnected, the temperature mode display will reset to Centigrade.

This is a normal condition. You can switch the temperature mode between Centigrade to Fahrenheit as follows;

- Automatic climate control system

While pressing the OFF button, press the AUTO button for 3 seconds or more. The display will change from Centigrade to Fahrenheit, or from Fahrenheit to Centigrade.

- “User setting mode” in the cluster :
You can change the temperature unit in the “Other features - Temperature unit”

Air intake control

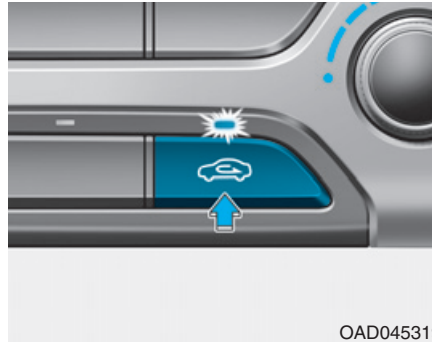

This is used to select the outside (fresh) air position or recirculated air position.

To change the air intake control position, push the control button.

Recirculated air position



With the recirculated air position selected, air from the passenger compartment will be drawn through the heating system and heated or cooled according to the function selected.

Outside (fresh) air position



With the outside (fresh) air position selected, air enters the vehicle from outside and is heated or cooled according to the function selected.

i Information

Prolonged operation of the heater in the recirculated air position (without air conditioning selected) may cause fogging of the windshield and side windows and the air within the passenger compartment may become stale.

In addition, prolonged use of the air conditioning with the recirculated air position selected will result in excessively dry air in the passenger compartment.

⚠ WARNING

- Continued climate control system operation in the recirculated air position may allow humidity to increase inside the vehicle which may fog the glass and obscure visibility.
- Do not sleep in a vehicle with the air conditioning or heating system on. It may cause serious harm or death due to a drop in the oxygen level and/or body temperature.
- Continued climate control system operation in the recirculated air position can cause drowsiness or sleepiness, and loss of vehicle control. Set the air intake control to the outside (fresh) air position as much as possible while driving.

Fan speed control



OAD045320

The fan speed can be set to the desired speed by pushing the fan speed control button.

The higher the fan speed is, the more air is delivered.

Pressing the OFF button turns off the fan.

Air conditioning

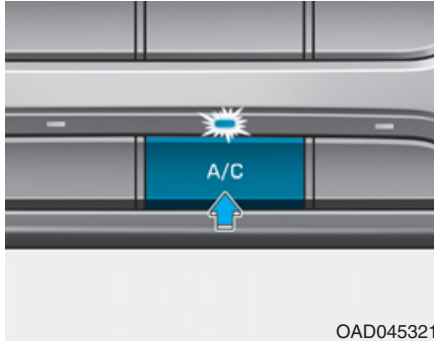

Push the A/C button to turn the air conditioning system on (indicator light will illuminate).

Push the button again to turn the air conditioning system off.

OFF mode

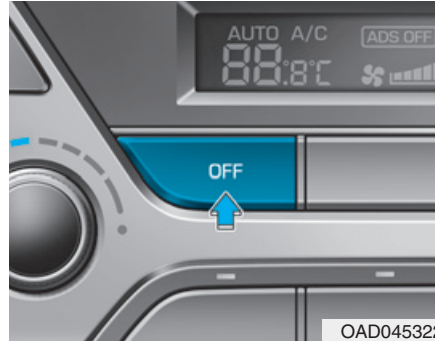



Push the OFF button of the front to turn off the air climate control system. However, you can still operate the mode and air intake buttons as long as the ignition switch is in the ON position.

System operation

Ventilation

1. Set the mode to the  position.
2. Set the air intake control to the outside (fresh) air position.
3. Set the temperature control to the desired position.
4. Set the fan speed control to the desired speed.

Heating

1. Set the mode to the  position.
2. Set the air intake control to the outside (fresh) air position.
3. Set the temperature control to the desired position.
4. Set the fan speed control to the desired speed.
5. If dehumidified heating is desired, turn the air conditioning system on.
 - If the windshield fogs up, set the mode to the  or  position.

Operation Tips

- To keep dust or unpleasant fumes from entering the vehicle through the ventilation system, temporarily set the air intake control to the recirculated air position. Be sure to return the control to the fresh air position when the irritation has passed to keep fresh air in the vehicle. This will help keep the driver alert and comfortable.
- Air for the heating/cooling system is drawn in through the grilles just ahead of the windshield. Care should be taken that these are not blocked by leaves, snow, ice or other obstructions.
- To prevent interior fog on the windshield, set the air intake control to the fresh air position and fan speed to the desired position, turn on the air conditioning system, and adjust the temperature control to desired temperature.

Air conditioning

HYUNDAI Air Conditioning Systems are filled with R-134a or R1234yf refrigerant.

1. Start the engine. Push the air conditioning button.
2. Set the mode to the  position.
3. Set the air intake control to the outside air or recirculated air position.
4. Adjust the fan speed control and temperature control to maintain maximum comfort.

Information

Your vehicle is filled with R-134a or R-1234yf according to the regulation in your country at the time of production. You can find out which air conditioning refrigerant is applied to your vehicle on the label located inside of the hood.

NOTICE

- The refrigerant system should only be serviced by trained and certified technicians to insure proper and safe operation.
- The refrigerant system should be serviced in a well-ventilated place.
- The air conditioning evaporator (cooling coil) shall never be repaired or replaced with one removed from a used or salvaged vehicle and new replacement MAC evaporators shall be certified (and labeled) as meeting SAE Standard J2842.

i Information

- When using the air conditioning system, monitor the temperature gauge closely while driving up hills or in heavy traffic when outside temperatures are high. Air conditioning system operation may cause engine overheating. Continue to use the blower fan but turn the air conditioning system off if the temperature gauge indicates engine overheating.
- When opening the windows in humid weather air conditioning may create water droplets inside the vehicle. Since excessive water droplets may cause damage to electrical equipment, air conditioning should only be used with the windows closed.

Air conditioning system operation tips

- If the vehicle has been parked in direct sunlight during hot weather, open the windows for a short time to let the hot air inside the vehicle escape.
- Use air conditioning to reduce humidity and moisture inside the vehicle on rainy or humid days.
- During air conditioning system operation, you may occasionally notice a slight change in engine speed as the air conditioning compressor cycles. This is a normal system operation characteristic.
- Use the air conditioning system every month only for a few minutes to ensure maximum system performance.
- When using the air conditioning system, you may notice clear water dripping (or even puddling) on the ground under the passenger side of the vehicle. This is a normal system operation characteristic.
- Operating the air conditioning system in the recirculated air position provides maximum cooling, however, continual operation in this mode may cause the air inside the vehicle to become stale.
- During cooling operation, you may occasionally notice a misty air flow because of rapid cooling and humid air intake. This is a normal system operation characteristic.

System maintenance

Climate control air filter

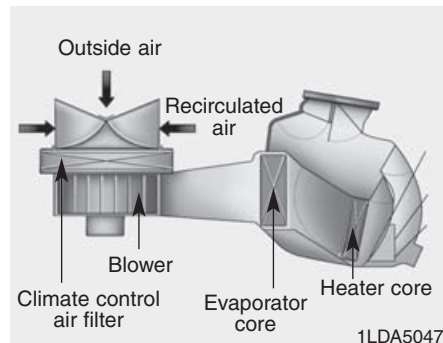

The climate control air filter installed behind the glove box filters the dust or other pollutants that come into the vehicle from the outside through the heating and air conditioning system. If dust or other pollutants accumulate in the filter over a period of time, the air flow from the air vents may decrease, resulting in moisture accumulation on the inside of the windshield even when the outside (fresh) air position is selected. If this happens, we recommend that the climate control air filter be replaced by an authorized HYUNDAI dealer.

i Information

- Replace the filter according to the Maintenance Schedule.

If the car is being driven in severe conditions such as dusty, rough roads, more frequent climate control air filter inspections and changes are required.

- When the air flow rate suddenly decreases, we recommend that the system be checked by an authorized **HYUNDAI** dealer.

Air Conditioning refrigerant label

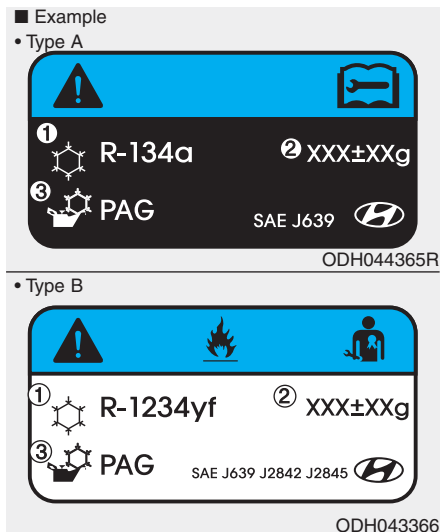

The actual Air Conditioning refrigerant label in the vehicle may differ from the illustration.

Each symbols and specification on air conditioning refrigerant label means as below :

1. Classification of refrigerant
2. Amount of refrigerant
3. Classification of Compressor lubricant

You can find out which air conditioning refrigerant is applied to your vehicle on the label located inside of the hood.

Checking the amount of air conditioner refrigerant and compressor lubricant

When the amount of refrigerant is low, the performance of the air conditioning is reduced. Overfilling also has a bad influence on the air conditioning system.

Therefore, if abnormal operation is found, we recommend that the system be inspected by an authorized HYUNDAI dealer.

⚠ WARNING

Vehicles equipped with R-134a



Because the refrigerant is at very high pressure, the air conditioning system should only be serviced by trained and certified technicians. It is important that the correct type and amount of oil and refrigerant is used.

Otherwise, it may cause damage to the vehicle and personal injury.

⚠ WARNING

Vehicles equipped with R-1234yf



Because the refrigerant is mildly inflammable at very high pressure, the air conditioning system should only be serviced by trained and certified technicians.



It is important that the correct type and amount of oil and refrigerant is used.

Otherwise, it may cause damage to the vehicle and personal injury.

WINDSHIELD DEFROSTING AND DEFOGGING

⚠ WARNING

Windshield heating



Do not use the  or  position during cooling operation in extremely humid weather. The difference between the temperature of the outside air and that of the windshield could cause the outer surface of the windshield to fog up, causing loss of visibility. In this case, set the mode selection knob or button to the  position and fan speed control knob or button to lower speed.

- For maximum defrosting, set the temperature control to the extreme right/hot position and the fan speed control to the highest speed.
- If warm air to the floor is desired while defrosting or defogging, set the mode to the floor-defrost position.
- Before driving, clear all snow and ice from the windshield, rear window, outside rear view mirrors, and all side windows.
- Clear all snow and ice from the hood and air inlet in the cowl grill to improve heater and defroster efficiency and to reduce the probability of fogging up inside of the windshield.

Manual climate control system

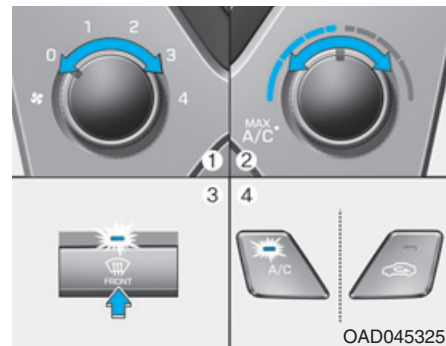
To defog inside windshield



1. Select any fan speed except “0” position.
2. Select desired temperature.
3. Select the  or  position.
4. The outside (fresh) air will be selected automatically. Additionally, the air conditioning (if equipped) will automatically operate if the mode is selected to the  position.

If the air conditioning and outside (fresh) air position are not selected automatically, press the corresponding button manually.

To defrost outside windshield



1. Set the fan speed to the highest (extreme right) position.
2. Set the temperature to the extreme hot position.
3. Select the  position.
4. The outside (fresh) air and air conditioning (if equipped) will be selected automatically.

Automatic climate control system

To defog inside windshield

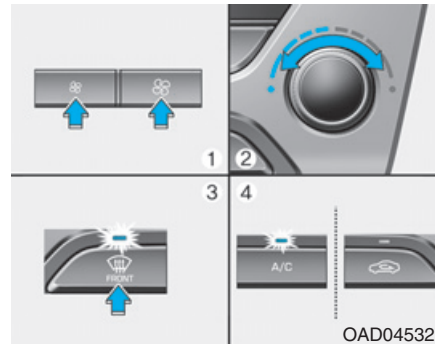



1. Select desired fan speed.
2. Select desired temperature.
3. Press the defroster button ().
4. The air-conditioning will turn on according to the detected ambient temperature, outside (fresh) air position and higher fan speed will be selected automatically.

If the air-conditioning, outside (fresh) air position and higher fan speed are not selected automatically, adjust the corresponding button or knob manually.

If the  position is selected, lower fan speed is controlled to higher fan speed.

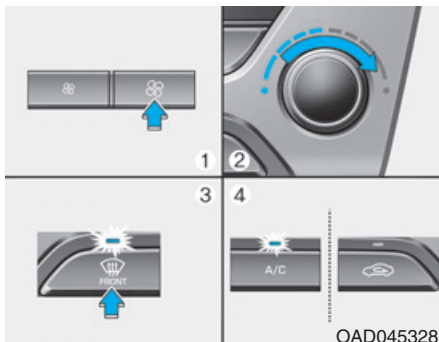

To defrost outside windshield



1. Set fan speed to the highest position.
2. Set temperature to the extreme hot (HI) position.
3. Press the defroster button ().
4. The air-conditioning will turn on according to the detected ambient temperature and outside (fresh) air position will be selected automatically.

If the  position is selected, lower fan speed is controlled to higher fan speed.

Defogging logic (if equipped)

To reduce the probability of fogging up the inside of the windshield, the air intake or air conditioning are controlled automatically according to certain conditions such as  or  position. To cancel or return the defogging logic, do the following.

Manual climate control system

1. Turn the ignition switch to the ON position.
2. Press the defroster button ().
3. Press the air intake control button at least 5 times within 10 seconds.

The indicator on the air intake button blinks 3 times. It indicates that the defogging logic is canceled or returned to the programmed status.

If the battery has been discharged or disconnected, it resets to the defog logic status.

Automatic climate control system

1. Turn the ignition switch to the ON position.
2. Press the defroster button ().
3. While pressing the air conditioning button (A/C), press the air intake control button at least 5 times within 3 seconds.

The climate control information screen will blink 3 times. It indicates that the defogging logic is canceled or returned to the programmed status.

If the battery has been discharged or disconnected, it resets to the defog logic status.

Auto defogging system (only for automatic climate control system, if equipped)

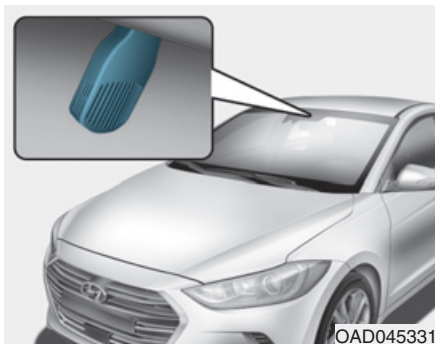

Auto defogging reduces the possibility of fogging up the inside of the windshield by automatically sensing the moisture of inside the windshield. The auto defogging system operates when the heater or air conditioning is on.

i Information

The auto defogging system may not operate normally, when the outside temperature is below -10°C .



When the Auto Defogging System operates, the indicator will illuminate.

If higher level of moisture are sensed in the vehicle, the Auto Defogging System will operate in the following order:

- Step 1 : Outside air position
- Step 2 : Operating the air conditioning
- Step 3 : Blowing air toward the windshield
- Step 4 : Increasing air flow toward the windshield

If the air conditioning is off or recirculated air position is manually selected while Auto Defogging System is ON, the Auto Defogging System Indicator will blink 3 times to signal that the manual operation has been canceled.

To cancel or reset the Auto Defogging System

Press the front windshield defroster button for 3 seconds when the ignition switch is in the ON position.

When the Auto Defogging System is canceled, ADS OFF symbol will blink 3 times and the ADS OFF will be displayed on the climate control information screen.

When the Auto Defogging System is reset, ADS OFF symbol will blink 6 times without a signal.

i Information

- When the air conditioning is turned on by Auto defogging system, if you try to turn off the air conditioning, the indicator will blink 3 times and the air conditioning will not be turned off.
- For efficiency, do not select recirculated air position while Auto defogging system is operating.

NOTICE

Do not remove the sensor cover located on the upper end of the driver side windshield glass.

Damage to system parts could occur and may not be covered by your vehicle warranty.

CLIMATE CONTROL ADDITIONAL FEATURES

Cluster ionizer (if equipped)

When the ignition switch is in the ON position, the clean air function turns on automatically.

Also, the clean air function turns off automatically, when the ignition switch is in the OFF position.

Sunroof inside air recirculation (if equipped)

If the sunroof opens while the heater or Air Conditioning system operates, the outside (fresh) air will be selected automatically for ventilating the car. Then, if you select the recirculated air position, the outside (fresh) air will be selected automatically after 3 minutes.

If you close the sunroof, the intake mode will be changed to the previous selected mode.

STORAGE COMPARTMENT

WARNING

Never store cigarette lighters, propane cylinders, or other flammable/explosive materials in the vehicle. These items may catch fire and/or explode if the vehicle is exposed to hot temperatures for extended periods.

WARNING

ALWAYS keep the storage compartment covers closed securely while driving. Items inside your vehicle are moving as fast as the vehicle. If you have to stop or turn quickly, or if there is a crash, the items may fly out of the compartment and may cause an injury if they strike the driver or a passenger.

NOTICE

To avoid possible theft, do not leave valuables in the storage compartments.

Center console storage

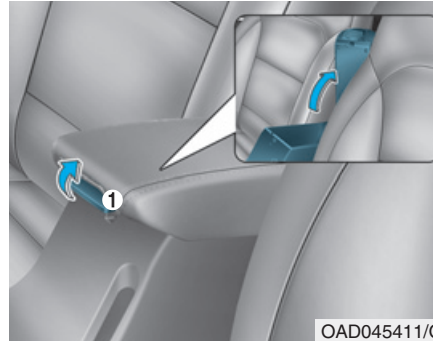

To open :
Press the button (1).

Sliding armrest (if equipped)

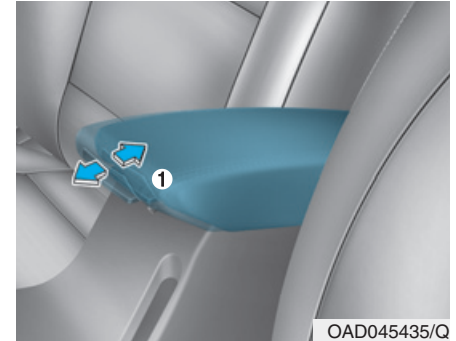

To move the armrest forward:
Grab the front portion of the armrest (1) then pull it forward.

To move the armrest rearward:
Push the armrest rearward.

WARNING

Do not grab the front portion of the armrest (1) when moving the armrest rearward. You may pinch your fingers.

Glove box

■ Left-hand drive

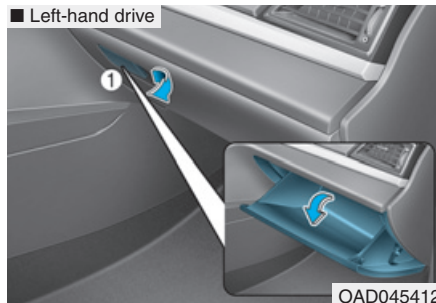

■ Right-hand drive

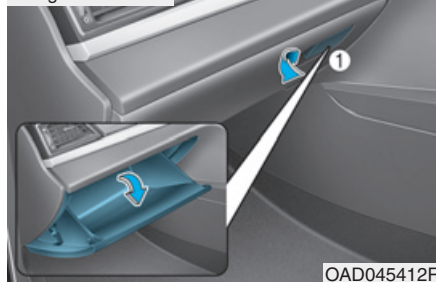

To open:
Pull the lever (1).

⚠ WARNING

ALWAYS close the glove box door after use.

An open glove box door can cause serious injury to the passenger in an accident, even if the passenger is wearing a seat belt.

Sunglass holder (if equipped)

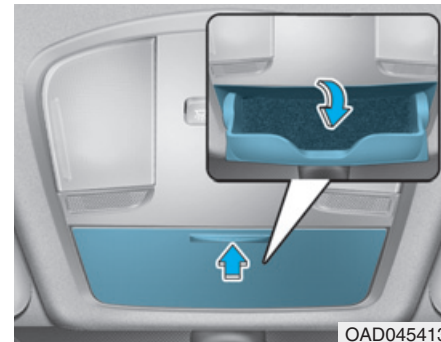

To open:

Press the cover and the holder will slowly open. Place your sunglasses in the compartment door with the lenses facing out.

To close:

Push back into position.

Make sure the sunglasses holder is closed while driving.

WARNING

- Do not keep objects except sunglasses inside the sunglass holder. Such objects can be thrown from the holder in the event of a sudden stop or an accident, possibly injuring the passengers in the vehicle.
- Do not open the sunglass holder while the vehicle is moving. The rear view mirror of the vehicle can be blocked by an open sunglass holder.
- Do not put the glasses forcibly into a sunglass holder. It may cause personal injury if you try to open it forcibly when the glasses are jammed in holder.

Multi box (if equipped)

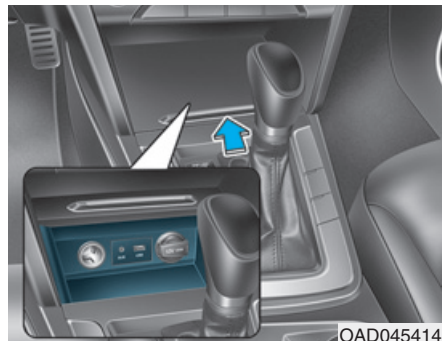

To open the cover, press the cover and it will slowly open. To close the cover, press the cover and it will slowly close.

For the safety of the passengers, when the cover is closed, the cover locks if the vehicle shakes by sudden acceleration and braking.

To unlock the cover, press the cover twice.

INTERIOR FEATURES

Ashtray (if equipped)

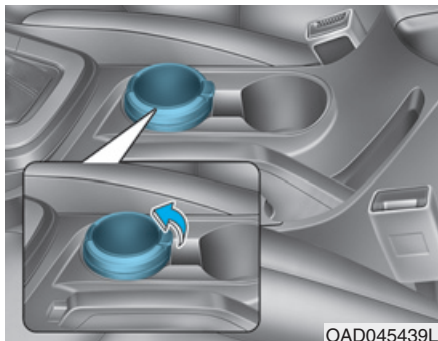

To use the ashtray, open the cover.

To clean the ashtray:

The plastic receptacle should be removed by lifting the plastic ashtray receptacle upward after turning the cover counterclockwise and pulling it out.

WARNING

Ashtray use

Putting lit cigarettes or matches in an ashtray with other combustible materials may cause a fire.

Cup holder

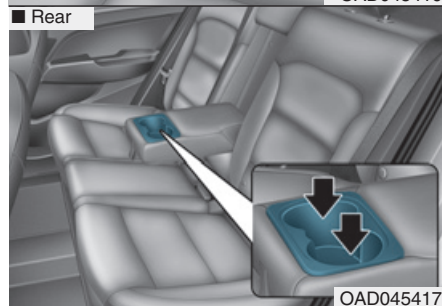
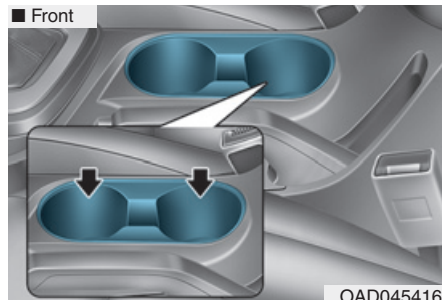

Front

Cups or small beverages cups may be placed in the cup holders.

Rear

Pull the armrest down to use the cup holders.

WARNING

- Avoid abrupt starting and braking when the cup holder is in use to prevent spilling your drink. If hot liquid spills, you could be burned. Such a burn to the driver could cause loss of vehicle control resulting in an accident.
- Do not place uncovered or unsecured cups, bottles, cans, etc., in the cup holder containing hot liquid while the vehicle is in motion. Injuries may result in the event of sudden stop or collision.
- Only use soft cups in the cup holders. Hard objects can injure you in an accident.

WARNING

Keep cans or bottles out of direct sun light and do not put them in a hot vehicle. It may explode.

NOTICE

- Keep your drinks sealed while driving to prevent spilling your drink. If liquid spills, it may get into the vehicle's electrical/electronic system and damage electrical/electronic parts.
- When cleaning spilled liquids, do not dry the cup holder at high temperature. This may damage the cup holder.

Sunvisor

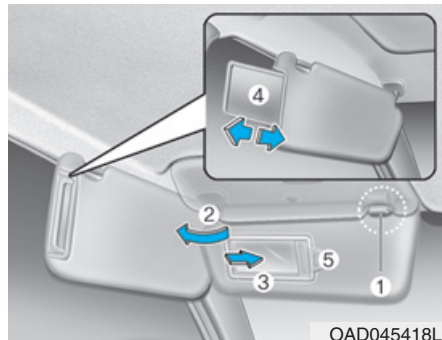

To use a sunvisor, pull it downward.

To use a sunvisor for a side window, pull it downward, unsnap it from the bracket (1) and swing it to the side (2).

To use the vanity mirror, pull down the sunvisor and slide the mirror cover (3).

Adjust the sunvisor forward or backward (4) as needed (if equipped). Use the ticket holder (5) to hold tickets.

Information

Close the vanity mirror cover securely and return the sunvisor to its original position after use.

WARNING

For your safety, do not block your view when using the sunvisor.

NOTICE

Do not put several tickets in the ticket holder at one time. This could cause damage to the ticket holder.

Power outlet (if equipped)

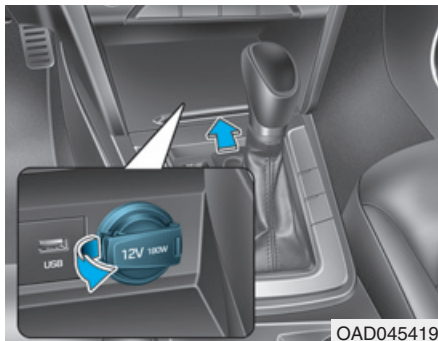

The power outlet is designed to provide power for mobile telephones or other devices designed to operate with vehicle electrical systems. The devices should draw less than 180 W(Watt) with the engine running.

⚠ WARNING

Avoid electrical shocks. Do not place your fingers or foreign objects (pin, etc.) into a power outlet or touch the power outlet with a wet hand.

NOTICE

To prevent damage to the Power Outlets :

- Use the power outlet only when the engine is running and remove the accessory plug after use. Using the accessory plug for prolonged periods of time with the engine off could cause the battery to discharge.
- Only use 12V electric accessories which are less than 180 W(Watt) in electric capacity.
- Adjust the air-conditioner or heater to the lowest operating level when using the power outlet.
- Close the cover when not in use.

(Continued)

(Continued)

- Some electronic devices can cause electronic interference when plugged into a vehicle's power outlet. These devices may cause excessive audio static and malfunctions in other electronic systems or devices used in your vehicle.
- Push the plug in as far as it will go. If good contact is not made, the plug may overheat and the fuse may open.
- Plug in battery equipped electrical/electronic devices with reverse current protection. The current from the battery may flow into the vehicle's electrical/electronic system and cause system malfunction.

USB charger

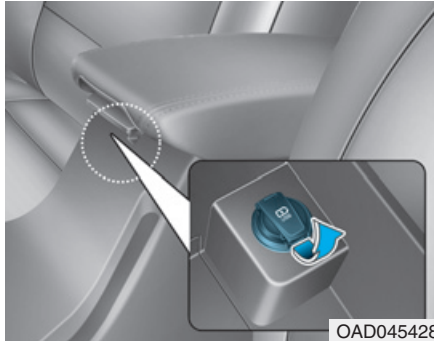

The USB charger is located inside the console box between the driver's seat and the front passenger's seat. Insert the USB charger into the USB port, and re-charge a smart phone or a tablet PC.

- A charging status/charging completion message is displayed on a screen of a smart phone or a tablet PC.
- A smart phone or a tablet PC may get warmer during the re-charging process. It does not indicate any malfunction with the charging system.

- A smart phone or a tablet PC, which adopts a different re-charging method, may not be properly re-charged. In this case, use an exclusive charger of your device.
- The charging terminal is only to re-charge a device. Do not use the charging terminal either to turn ON an audio or to play media on the AVN.

Cigarette lighter (if equipped)

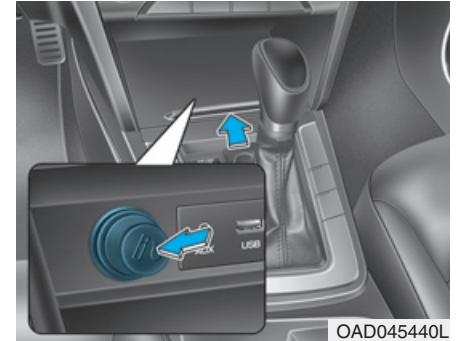

To use the cigarette lighter, the ignition switch must be in the ACC or ON position.

Push the cigarette lighter all the way into its socket. When the element is heated, the lighter will pop out to the "ready" position.

We recommend that you use parts for replacement from an authorized HYUNDAI dealer.

⚠ WARNING

- Do not hold the lighter in after it is already heated because it will overheat.
- If the lighter does not pop out within 30 seconds, remove it to prevent overheating.
- Do not insert foreign objects into the socket of the cigarette lighter. It may damage the cigarette lighter.

NOTICE

Only a genuine HYUNDAI lighter should be used in the cigarette lighter socket. The use of plug-in accessories (shavers, hand-held vacuums, and coffee pots, etc.) may damage the socket or cause electrical failure.

Clock

⚠ WARNING

Do not adjust the clock while driving. You may lose your steering control and cause severe personal injury or accidents.

For more details, please refer to the manual that was supplied with your vehicle.

Clothes hanger (if equipped)

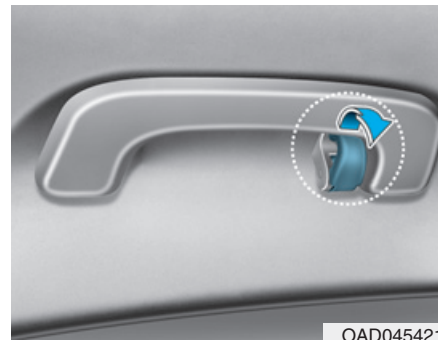

To hang items, pull the hanger down. These hangers are not designed to hold large or heavy items.

⚠ WARNING

Do not hang other objects except clothes. In an accident it may cause vehicle damage or personal injury.

Floor mat anchor(s) (if equipped)

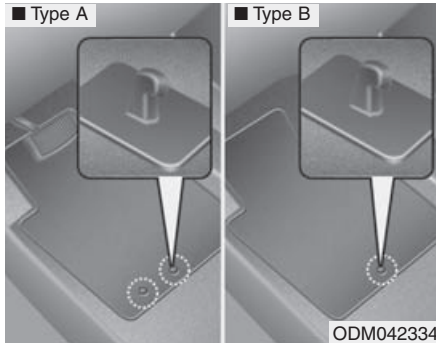

ALWAYS use the Floor Mat Anchors to attach the front floor mats to the vehicle. The anchors on the front floor carpet keep the floor mats from sliding forward.

⚠ WARNING

The following must be observed when installing ANY floor mat to the vehicle.

- Ensure that the floor mats are securely attached to the vehicle's floor mat anchor(s) before driving the vehicle.
- Do not use ANY floor mat that cannot be firmly attached to the vehicle's floor mat anchors.
- Do not stack floor mats on top of one another (e.g. all-weather rubber mat on top of a carpeted floor mat). Only a single floor mat should be installed in each position.

IMPORTANT - Your vehicle was manufactured with driver's side floor mat anchors that are designed to securely hold the floor mat in place. To avoid any interference with pedal operation, HYUNDAI recommends that the HYUNDAI floor mat designed for use in your vehicle be installed.

Luggage net (holder) (if equipped)



To keep items from shifting in the cargo area, you can use the four holders located in the cargo area to attach the luggage net.

If necessary, we recommend that you contact your authorized HYUNDAI dealer to obtain a luggage net.

NOTICE

Vehicles equipped with a luggage rail system may use the shackles to hook the luggage net.



CAUTION

To prevent damage to the goods or the vehicle, care should be taken when carrying fragile or bulky objects in the luggage compartment.



WARNING

To avoid eye injury, **DO NOT** overstretch the luggage net. **ALWAYS** keep your face and body out of the luggage net's recoil path. **DO NOT** use the luggage net when the strap has visible signs of wear or damage.

Multimedia System

Multimedia system	4-2
Aux, USB and iPod® port	4-2
Antenna	4-3
Steering wheel audio control	4-4
Audio / Video / Navigation system (AVN)	4-5
<i>Bluetooth</i> ® Wireless Technology hands-free	4-5
How vehicle radio works	4-6
Audio (Without Touch Screen)	4-9
Feature of Your Audio	4-10
Radio Mode (Type A-1, Type A-2, Type A-3, Type A-4 with RDS).....	4-28
Radio Mode (Type A-5, Type A-6).....	4-30
Media Mode.....	4-31
Phone Mode	4-38
Setup Mode (Type A-1, Type A-2, Type A-3, Type A-4).....	4-40
Setup Mode (Type A-5, Type A-6).....	4-46
Audio (With Touch Screen)	4-54
Feature of Your Audio	4-55
Radio Mode (Type B-1, Type B-2, Type B-3, Type B-4)	4-72
Radio Mode (Type B-5, Type B-6).....	4-74
Media Mode.....	4-75
Phone Mode	4-90
<i>Bluetooth</i> ® Wireless Technology (Type B-1, Type B-2, Type B-3, Type B-4)	4-90
<i>Bluetooth</i> ® Wireless Technology (Type B-5, Type B-6).....	4-97
Setup Mode (Type B-1, Type B-2, Type B-3, Type B-4)	4-103
Setup Mode (Type B-5, Type B-6)	4-110
Declaration of Conformity	4-117
FCC	4-117
CE for EU	4-119
PCC for Taiwan	4-121
ACMA for Australia	4-122
ANATEL for Brazil.....	4-124
SMA for Jamaica	4-127
IFETEL for Mexico	4-128
MOC for Israel	4-129

MULTIMEDIA SYSTEM

i Information

- If you install an aftermarket HID headlamp, your vehicle's audio and electronic device may malfunction.
- Prevent chemicals such as perfume, cosmetic oil, sun cream, hand cleaner, and air freshener from contacting the interior parts because they may cause damage or discoloration.

AUX, USB and iPod® port



You can use an AUX port to connect audio devices and an USB port to plug in an USB and also in an iPod® port.

i Information

When using a portable audio device connected to the power outlet, noise may occur during playback. If this happens, use the power source of the portable audio device.

* iPod® is a trademark of Apple Inc.

Antenna

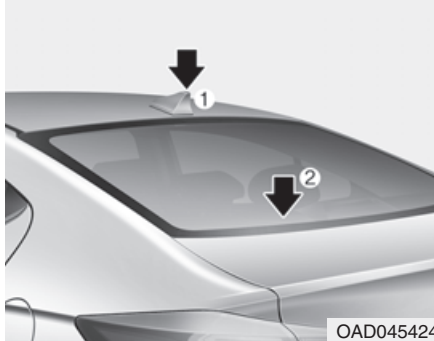

Shark fin antenna (1, if equipped)

The shark fin antenna will receive the transmit data.

(for example : GPS)

Glass antenna (2)

Your vehicle uses a glass antenna to receive both AM and FM signals.

NOTICE

- Do not clean the inside of the rear window glass with a cleaner or use a scraper to remove foreign deposits as this may cause damage to the antenna elements.
- Avoid adding metallic coatings such as Ni, Cd, and so on. These can degrade the receiving AM and FM broadcast signals.

NOTICE

- To prevent damage to the rear glass antenna, never use sharp instruments or window cleaner containing abrasives to clean the window. Clean the inside surface of the rear glass window with a piece of soft cloth.
- When putting a sticker on the inside surface of the rear window, be careful not to damage to the rear glass antenna.
- Do not put sharp instruments nearby the rear glass antenna.
- Tinted rear window may affect the proper functioning of the antenna.

Steering wheel audio control (if equipped)

■ Type A



■ Type B

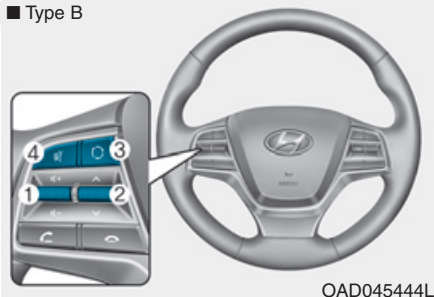

The steering wheel audio control button is installed for your convenience.

NOTICE

Do not operate audio remote control buttons simultaneously.

VOLUME (VOL + / -) (1)

- Move the VOLUME lever up to increase volume.
- Move the VOLUME lever down to decrease volume.

SEEK/PRESET (^ / v) (2)

If the SEEK/PRESET lever is moved up or down and held for 0.8 second or more, it will function in the following modes.

RADIO mode

It will function as the AUTO SEEK select button. It will SEEK until you release the button.

MEDIA mode

It will function as the FF/REW button.

If the SEEK/PRESET lever is moved up or down, it will function in the following modes.

RADIO mode

It will function as the PRESET STATION UP/DOWN button.

MEDIA mode

It will function as the TRACK UP/DOWN button.

MODE () (3)

Press the MODE button to select Radio, Disc, or AUX.

MUTE () (4)

- Press the button to mute the sound.
- Press the button again to activate the sound.

i Information

Detailed information for audio control buttons are described in the following pages in this chapter.

Audio / Video / Navigation system (AVN) (if equipped)

Detailed information for the AVN system is described in a separately supplied manual.

Bluetooth® Wireless Technology hands-free (if equipped)

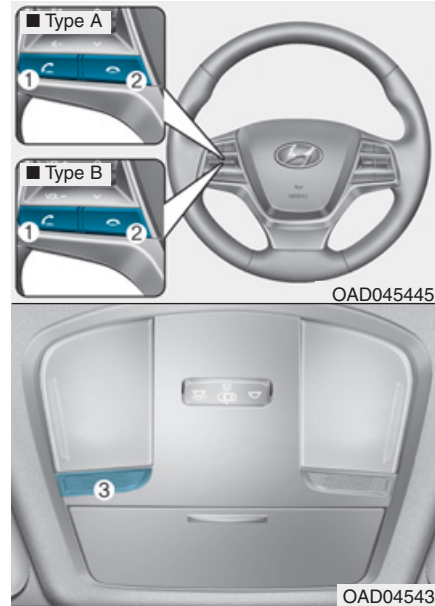

You can use the phone wirelessly by using the *Bluetooth®* Wireless Technology.

- (1) Call / Answer button
- (2) Call end button
- (3) Microphone

- Audio : For detailed information, refer to “AUDIO” in this chapter.
- AVN : Detailed information for the *Bluetooth®* Wireless Technology hands-free is described in the manual supplied separately.

How vehicle radio works

FM reception

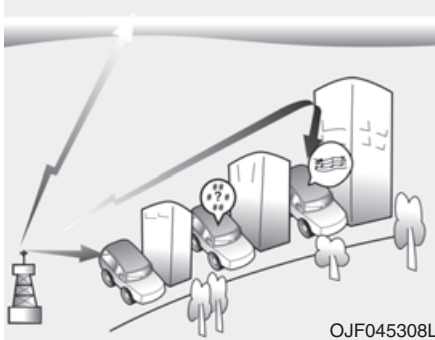

AM and FM radio signals are broadcast from transmitter towers located around your city. They are intercepted by the radio antenna on your vehicle. This signal is then received by the radio and sent to your vehicle speakers.

When a strong radio signal has reached your vehicle, the precise engineering of your audio system ensures the best possible quality reproduction. However, in some cases the signal coming to your vehicle may not be strong and clear.

This can be due to factors, such as the distance from the radio station, closeness of other strong radio stations or the presence of buildings, bridges or other large obstructions in the area.

AM (MW, LW) reception

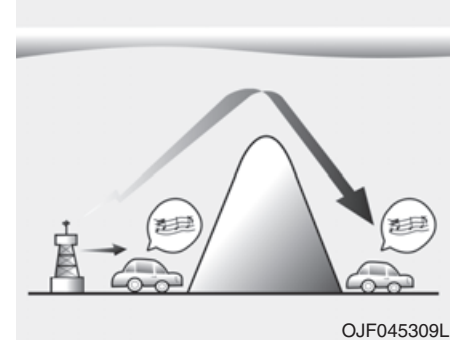

AM broadcasts can be received at greater distances than FM broadcasts. This is because AM radio waves are transmitted at low frequencies. These long, low frequency radio waves can follow the curvature of the earth rather than travelling straight out into the atmosphere. In addition, they curve around obstructions so that they can provide better signal coverage.

FM radio station

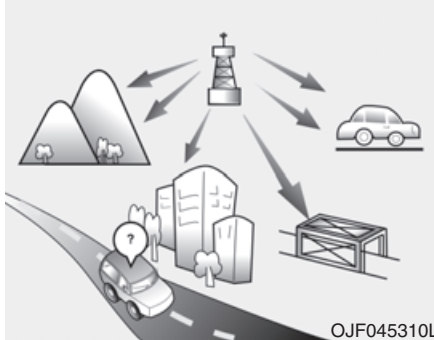

FM broadcasts are transmitted at high frequencies and do not bend to follow the earth's surface. Because of this, FM broadcasts generally begin to fade at short distances from the station. Also, FM signals are easily affected by buildings, mountains, or other obstructions. These can result in certain listening conditions which might lead you to believe a problem exists with your radio. The following conditions are normal and do not indicate radio trouble :

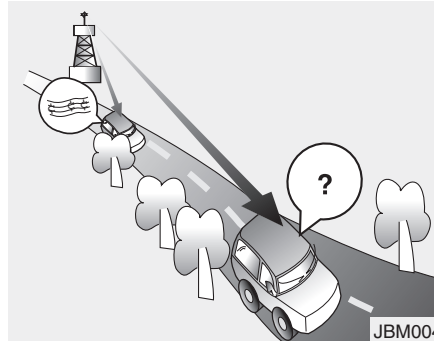

- **Fading** - As your vehicle moves away from the radio station, the signal will weaken and sound will begin to fade. When this occurs, we suggest that you select another stronger station.
- **Flutter/Static** - Weak FM signals or large obstructions between the transmitter and your radio can disturb the signal causing static or fluttering noises to occur. Reducing the treble level may lessen this effect until the disturbance clears.

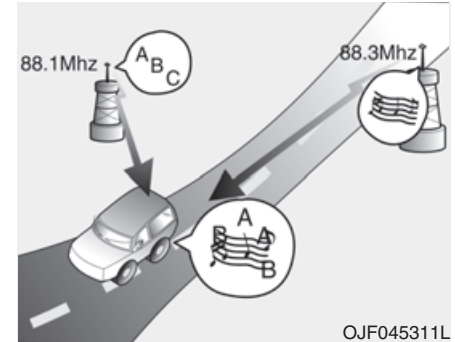

- **Station Swapping** - As a FM signal weakens, another more powerful signal near the same frequency may begin to play. This is because your radio is designed to lock onto the clearest signal. If this occurs, select another station with a stronger signal.
- **Multi-Path Cancellation** - Radio signals being received from several directions can cause distortion or fluttering. This can be caused by a direct and reflected signal from the same station, or by signals from two stations with close frequencies. If this occurs, select another station until the condition has passed.

Using a cellular phone or a two-way radio

When a cellular phone is used inside the vehicle, noise may be produced from the audio system. This does not mean that something is wrong with the audio equipment. In such a case, use the cellular phone at a place as far as possible from the audio equipment.

NOTICE

When using a communication system such as a cellular phone or a radio set inside the vehicle, a separate external antenna must be fitted. When a cellular phone or a radio set is used with an internal antenna alone, it may interfere with the vehicle's electrical system and adversely affect safe operation of the vehicle.

WARNING

Do not use a cellular phone while driving. Stop at a safe location to use a cellular phone.

AUDIO (Without Touch Screen)

■ Type A-1



(With *Bluetooth*® Wireless Technology)

■ Type A-2



ADA50000EE/ADA50001EE

Feature of Your Audio



(1) EJECT

- Ejects the disc.

(2) RADIO (Type A-1)

- Changes to FM/AM mode.
- Each time the button is pressed, the mode is changed in order of FM1 → FM2 → FMA → AM → AMA.

(3) MEDIA

- Changes to CD, USB(iPod®), AUX, My Music*, BT Audio* mode.
- Each time the button is pressed, the mode is changed in order of CD, USB(iPod®), AUX, My Music*, BT Audio*.

*if equipped

(4) PHONE (Type A-1)

- Operates Phone Screen.
- When a phone is not connected, the connection screen is displayed.

(5) SEEK TRACK

- Radio mode : Automatically searches for broadcast frequencies.
- CD, USB, iPod®, My Music* mode
 - Shortly press the button : Moves to next or previous song (file).
 - Press and hold the button : Rewinds or fast-forwards the current song.

*if equipped

(6) POWER/VOLUME knob

- Power knob : Turns power On/Off by pressing the knob.
- Volume knob : Sets volume by turning the knob left/right.

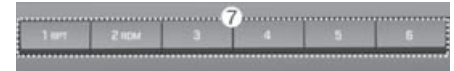

(7) [1] ~ [6] (Preset)

- Radio mode : Saves frequencies (channels) or receives saved frequencies (channels).
- CD, USB, iPod®, My Music* mode
 - [RPT] : Repeat
 - [RDM] : Random

In the Radio, Media, Setup, and Menu pop up screen, the number menu is selected.

*if equipped



(8) **DISP**

- Each time the button is shortly pressed, sets Screen Off → Screen On → Screen Off.
- Audio operation is maintained and only the screen will be turned Off.
- In the Screen Off state, press any button to turn the Screen On again.

(9) **TA/SCAN**

- Radio mode
 - Shortly press the button : TA On/Off.
 - Press and hold the button : Previews each broadcast for 5 seconds each.
- CD, USB, My Music* mode
 - Press and hold the button : Previews each song (file) for 10 seconds each.
 - Press and hold the button again to continue listening to the current song (file).

*if equipped

(10) **SETUP/CLOCK**

- Shortly press the button : Moves to the Display, Sound, Clock, Phone, System setting modes.
- Press and hold the button : Move to the Time setting screen.

(11) **MENU**

- Displays menus for the current mode.
- iPod® List : Move to parent category.

(12) **FOLDER**

- MP3 CD / USB mode : Folder Search.

(13) **TUNE** knob

- Radio mode : Changes frequency by turning the knob left/right.
- CD, USB, iPod®, My Music* mode : Searches songs (files) by turning the knob left/right.

When the desired song is displayed, press the knob to play the song.

- Moves focus in all selection menus and selects menus.

*if equipped



(14) **FM (Type A-2)**

- Changes to FM mode.
- Each time the button is pressed, the mode changed in order of FM1 → FM2 → FMA.

(15) **AM (Type A-2)**

- Changes to AM → AMA mode.

■ Type A-3



(With *Bluetooth*® Wireless Technology)

■ Type A-4



ADA50002EE/ADA50003EE

Feature of Your Audio



(1) EJECT

- Ejects the disc.

(2) RADIO (Type A-3)

- Changes to FM/AM mode.
- Each time the button is pressed, the mode is changed in order of FM1 → FM2 → FMA → AM → AMA.

(3) MEDIA

- Changes to CD, USB(iPod®), AUX, My Music*, BT Audio* mode.
- Each time the button is pressed, the mode is changed in order of CD, USB(iPod®), AUX, My Music*, BT Audio*.

*if equipped

(4) PHONE (Type A-3)

- Operates Phone Screen.
- When a phone is not connected, the connection screen is displayed.

(5) SEEK TRACK

- Radio mode : Automatically searches for broadcast frequencies.
- CD, USB, iPod®, My Music* mode
 - Shortly press the button : Moves to next or previous song (file).
 - Press and hold the button : Rewinds or fast-forwards the current song.

*if equipped

(6) PWR/VOL knob

- Power knob : Turns power On/Off by pressing the knob.
- Volume knob : Sets volume by turning the knob left/right.



(7) [1] ~ [6] (Preset)

- Radio mode : Saves frequencies (channels) or receives saved frequencies (channels).
- CD, USB, iPod®, My Music* mode
 - [RPT] : Repeat
 - [RDM] : Random

In the Radio, Media, Setup, and Menu pop up screen, the number menu is selected.

*if equipped



(8) **DISP**

- Each time the button is shortly pressed, sets Screen Off → Screen On → Screen Off.
- Audio operation is maintained and only the screen will be turned Off.
- In the Screen Off state, press any button to turn the Screen On again.

(9) **TA/SCAN**

- Radio mode
 - Shortly press the button : TA On/Off.
 - Press and hold the button : Previews each broadcast for 5 seconds each.
- CD, USB, My Music* mode
 - Press and hold the button : Previews each song (file) for 10 seconds each.
 - Press and hold the button again to continue listening to the current song (file).

*if equipped

(10) **SETUP/CLOCK**

- Shortly press the button : Moves to the Display, Sound, Clock, Phone, System setting modes.
- Press and hold the button : Move to the Time setting screen.

(11) **MENU**

- Displays menus for the current mode.
- iPod® List : Move to parent category.

(12) **FOLDER**

- MP3 CD / USB mode : Folder Search.

(13) **TUNE** knob

- Radio mode : Changes frequency by turning the knob left/right.
- CD, USB, iPod®, My Music* mode : Searches songs (files) by turning the knob left/right.

When the desired song is displayed, press the knob to play the song.

- Moves focus in all selection menus and selects menus.

*if equipped



(14) **FM (Type A-4)**

- Changes to FM mode.
- Each time the button is pressed, the mode changed in order of FM1 → FM2 → FMA.

(15) **AM (Type A-4)**

- Changes to AM mode.
- Each time the button is pressed, the mode changed in order of AM → AMA.

■ Type A-5



(With *Bluetooth*® Wireless Technology)

■ Type A-6



ADA50004EE/ADA50005EE

Feature of Your Audio



(1) EJECT

- Ejects the disc.

(2) RADIO (Type A-5)

- Changes to FM/AM mode.
- Each time the button is pressed, the mode is changed in order of FM1 → FM2 → AM.

(3) MEDIA

- Changes to CD, USB(iPod®), AUX, My Music*, BT Audio* mode.
- Each time the button is pressed, the mode is changed in order of CD, USB(iPod®), AUX, My Music*, BT Audio*.

*if equipped

(4) PHONE (Type A-5)

- Operates Phone Screen.
- When a phone is not connected, the connection screen is displayed.

(5) SEEK TRACK

- Radio mode : Automatically searches for broadcast frequencies.
- CD, USB, iPod®, My Music* mode
 - Shortly press the button : Moves to next or previous song (file).
 - Press and hold the button : Rewinds or fast-forwards the current song.

*if equipped

(6) PWR/VOL knob

- Power knob : Turns power On/Off by pressing the knob.
- Volume knob : Sets volume by turning the knob left/right.

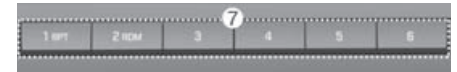

(7) [1] ~ [6] (Preset)

- Radio mode : Saves frequencies (channels) or receives saved frequencies (channels).
- CD, USB, iPod®, My Music* mode
 - [RPT] : Repeat
 - [RDM] : Random

In the Radio, Media, Setup, and Menu pop up screen, the number menu is selected.

*if equipped



(8) **DISP**

- Each time the button is shortly pressed, sets Screen Off → Screen On → Screen Off.
- Audio operation is maintained and only the screen will be turned Off.
- In the Screen Off state, press any button to turn the Screen On again.

(9) **SCAN**

- Radio mode
 - Press the button : Previews each broadcast for 5 seconds each.
- CD, USB, My Music* mode
 - Press the button : Previews each song (file) for 10 seconds each.
 - Press the button again to continue listening to the current song (file).

*if equipped

(10) **SETUP/CLOCK**

- Shortly press the button : Moves to the Display, Sound, Clock, Phone, System setting modes.
- Press and hold the button : Move to the Time setting screen.

(11) **MENU**

- Displays menus for the current mode.
- iPod® List : Move to parent category.

(12) **FOLDER**

- MP3 CD / USB mode : Folder Search.

(13) **TUNE** knob

- Radio mode : Changes frequency by turning the knob left/right.
- CD, USB, iPod®, My Music* mode : Searches songs (files) by turning the knob left/right.

When the desired song is displayed, press the knob to play the song.

- Moves focus in all selection menus and selects menus.

*if equipped



(14) FM (Type A-6)

- Changes to FM mode.
- Each time the button is pressed, the mode changed in order of FM1 → FM2.

(15) AM (Type A-6)

- Changes to AM mode.

i Information
- Using the Discs

- If the temperature inside the car is too high, open the car windows to ventilate before using the system.
- It is illegal to copy and use MP3/WMA files without permission. Use CDs that are created only by lawful means.
- Do not apply volatile agents, such as benzene and thinner, normal cleaners and magnetic sprays made for analogue disc onto CDs.
- To prevent the disc surface from getting damaged, hold CDs by the edges or the center hole only.
- Clean the disc surface with a piece of soft cloth before playback (wipe it from the center to the outside edge).
- Do not damage the disc surface or attach pieces of sticky tape or paper.
- Make certain only CDs are inserted into the CD player (Do not insert more than one CD at a time).
- Keep CDs in their cases after use to protect them from scratches or dirt.

(Continued)

(Continued)

- Depending on the type of CD-R/CD-RW CDs, certain CDs may not operate normally according to manufacturing companies or making and recording methods. In such circumstances, continued use may cause malfunctions to your audio system.

i Information
- Playing an Incompatible Copy Protected Audio CD

Some copy protected CDs, which do not comply with international audio CD standards (Red Book), may not play on your car audio. Please note that inability to properly play a copy protected CD may indicate that the CD is defective, not the CD player.

NOTE:

Order of playing files (folders) :

1. Song playing order : ① to ⑭ sequentially.
2. Folder playing order :
 - * If no song file is contained in the folder, that folder is not displayed.

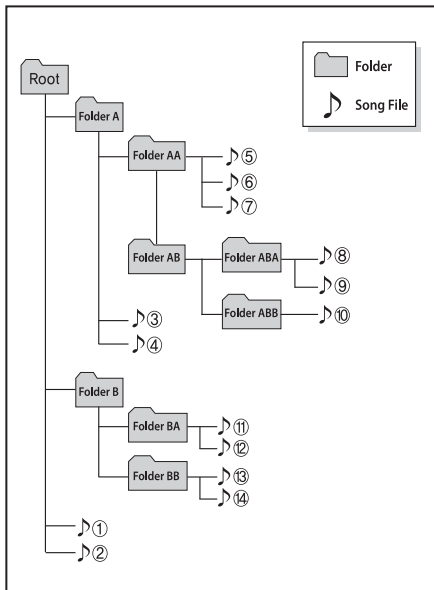
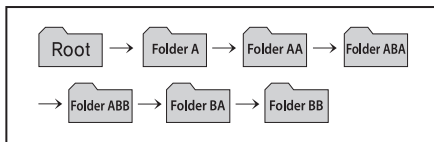

⚠ WARNING

- Do not stare at the screen while driving. Staring at the screen for prolonged periods of time could lead to traffic accidents.
- Do not disassemble, assemble, or modify the audio system. Such acts could result in accidents, fire, or electric shock.
- Using the phone while driving may lead to a lack of attention of traffic conditions and increase the likelihood of accidents. Use the phone feature after parking the vehicle.
- Heed caution not to spill water or introduce foreign objects into the device. Such acts could lead to smoke, fire, or product malfunction.

(Continued)

(Continued)

- Please refrain from use if the screen is blank or no sound can be heard as these signs may indicate product malfunction. Continued use in such conditions could lead to accidents (fires, electric shock) or product malfunctions.
- Do not touch the antenna during thunder or lightening as such acts may lead to lightning induced electric shock.
- Do not stop or park in parking-restricted areas to operate the product. Such acts could lead to traffic accidents.
- Use the system with the vehicle ignition turned on. Prolonged use with the ignition turned off could result in battery discharge.

⚠ WARNING

Driving while distracted can result in a loss of vehicle control that may lead to an accident, severe personal injury, and death. The driver's primary responsibility is in the safe and legal operation of a vehicle, and use of any handheld devices, other equipment, or vehicle systems which take the driver's eyes, attention and focus away from the safe operation of a vehicle or which are not permissible by law should never be used during operation of the vehicle.

NOTICE

- Operating the device while driving could lead to accidents due to a lack of attention to external surroundings. First park the vehicle before operating the device.
- Adjust the volume to levels that allow the driver to hear sounds from outside of the vehicle. Driving in a state where external sounds cannot be heard may lead to accidents.
- Pay attention to the volume setting when turning the device on. A sudden output of extreme volume upon turning the device on could lead to hearing impairment. (Adjust the volume to a suitable levels before turning off the device.)
- If you want to change the position of device installation, please inquire with your place of purchase or service maintenance center. Technical expertise is required to install or disassemble the device.

(Continued)

(Continued)

- Turn on the car ignition before using this device. Do not operate the audio system for long periods of time with the ignition turned off as such operations may lead to battery discharge.
- Do not subject the device to severe shock or impact. Direct pressure onto the front side of the monitor may cause damage to the LCD or touch screen.
- When cleaning the device, make sure to turn off the device and use a dry and smooth cloth. Never use tough materials, chemical cloths, or solvents (alcohol, benzene, thinners, etc.) as such materials may damage the device panel or cause color/quality deterioration
- Do not place beverages close to the audio system. Spilling beverages may lead to system malfunction.
- In case of product malfunction, please contact your place of purchase or After Service center.
- Placing the audio system within an electromagnetic environment may result in noise interference.

i Information

- Using the USB Device

- To use an external USB device, make sure the device is not connected when starting up the vehicle. Connect the device after starting up.
 - If you start the engine when the USB device is connected, it may damage the USB device. (USB flash-drives are very sensitive to electric shock.)
 - If the engine is started up or turned off while the external USB device is connected, the external USB device may not work.
 - The System may not play inauthentic MP3 or WMA files.
- 1) It can only play MP3 files with the compression rate between 8Kbps ~ 320Kbps.
 - 2) It can only play WMA music files with the compression rate between 8Kbps ~ 320Kbps.
- Take precautions for static electricity when connecting or disconnecting the external USB device.

(Continued)

(Continued)

- An encrypted MP3 PLAYER is not recognizable.
- Depending on the condition of the external USB device, the connected external USB device can be unrecognizable.
- When the formatted byte/sector setting of External USB device is not either 512BYTE or 2048BYTE, then the device will not be recognized.
- Use only a USB device formatted to FAT 12/16/32.
- USB devices without USB I/F authentication may not be recognizable.
- Make sure the USB connection terminal does not come in contact with the human body or other objects.
- If you repeatedly connect or disconnect the USB device in a short period of time, it may break the device.
- You may hear a strange noise when connecting or disconnecting a USB device.

(Continued)

(Continued)

- If you disconnect the external USB device during playback in USB mode, the external USB device can be damaged or may malfunction. Therefore, disconnect the external USB device when the audio is turned off or in another mode. (e.g, Radio, CD)
- Depending on the type and capacity of the external USB device or the type of the files stored in the device, there is a difference in the time taken for recognition of the device.
- Do not use the USB device for purposes other than playing music files.
- Playing videos through the USB is not supported.

(Continued)

(Continued)

- Use of USB accessories such as rechargers or heaters using USB I/F may lower performance or cause trouble.
- If you use devices such as a USB hub purchased separately, the vehicle's audio system may not recognize the USB device. In that case, connect the USB device directly to the multimedia terminal of the vehicle.
- If the USB device is divided by logical drives, only the music files on the highest-priority drive are recognized by car audio.
- Devices such as MP3 Player/Cellular phone/Digital camera can be unrecognizable by standard USB I/F can be unrecognizable.
- Charging through the USB may not be supported in some mobile devices.
- USB HDD or USB types liable to connection failures due to vehicle vibrations are not supported. (i-stick type)

(Continued)

(Continued)

- Some non-standard USB devices (METAL COVER TYPE USB) can be unrecognizable.
- Some USB flash memory readers (such as CF, SD, micro SD, etc.) or external-HDD type devices can be unrecognizable.
- Music files protected by DRM (DIGITAL RIGHTS MANAGEMENT) are not recognizable.
- The data in the USB memory may be lost while using this audio. Always back up important data on a personal storage device.
- Please avoid using USB memory products which can be used as key chains or cellular phone accessories as they could cause damage to the USB jack. Please make certain only to use plug type connector products.



i Information

- Using the iPod® Device

- Some iPod® models may not support communication protocol and files may not properly play.

Supported iPod® models :

- iPhone® 3GS/4
- iPod® touch 1st~4th generation
- iPod® nano 1st~6th generation
- iPod® classic
- The order of search or playback of songs in the iPod® can be different from the order searched in the audio system.
- If the iPod® disabled due to its own malfunction, reset the iPod®. (Reset: Refer to iPod® manual)
- An iPod® may not operate normally on low battery.

(Continued)

(Continued)

- Some iPod® devices, such as the iPhone®, can be connected through the *Bluetooth*® Wireless Technology interface. The device must have audio *Bluetooth*® Wireless Technology capability (such as for stereo headphone *Bluetooth*® Wireless Technology). The device can play, but it will not be controlled by the audio system.
- To use iPod® features within the audio, use the cable provided upon purchasing an iPod® device.
- Skipping or improper operation may occur depending on the characteristics of your iPod®/iPhone® device.
- If your iPhone® is connected to both the *Bluetooth*® Wireless Technology and USB, the sound may not be properly played. In your iPhone®, select the Dock connector or *Bluetooth*® Wireless Technology to change the sound output (source).

(Continued)

(Continued)

- When connecting iPod® with the iPod® Power Cable, insert the connector to the multimedia socket completely. If not inserted completely, communications between iPod® and audio may be interrupted.
- When adjusting the sound effects of the iPod® and the audio system, the sound effects of both devices will overlap and might reduce or distort the quality of the sound.
- Deactivate (turn off) the equalizer function of an iPod® when adjusting the audio system's volume, and turn off the equalizer of the audio system when using the equalizer of an iPod®.
- When not using iPod® with car audio, detach the iPod® cable from iPod®. Otherwise, iPod® may remain in accessory mode, and may not work properly.
- Beside support 1M cable when purchasing iPod®/iPhone® products, Long Cable cannot be recognized.

i Information

- Using the *Bluetooth*® Wireless Technology Cellular Phone (if equipped)

- *Bluetooth*® Wireless Technology Handsfree refers to a device which allows the user to conveniently make phone calls with *Bluetooth*® Wireless Technology mobile phones through the audio system.
- *Bluetooth*® Wireless Technology allows devices to be connected in a short distance, including hands-free devices, stereo headsets, wireless remote controllers, etc. For more information, visit the *Bluetooth*® Wireless Technology website at www.Bluetooth.com. Before using *Bluetooth*® Wireless Technology audio features.

(Continued)

(Continued)

- The Bluetooth® word mark and logos are registered trademarks owned by Bluetooth® SIG, Inc. and any use of such marks by Hyundai is under license. Other trademarks and trade names are those of their respective owners. A Bluetooth® enabled cell phone is required to use Bluetooth® Wireless Technology.
- Bluetooth® Wireless Technology features supported within the vehicle are as follows. Some features may not be supported depending on your Bluetooth® Wireless Technology device.
 - Answering and placing Bluetooth® Wireless Technology Handsfree calls
 - Menu operation during call (Switch to Private, Switch to call waiting, Outgoing volume)
 - Download Call History
 - Download Mobile Phone book
 - Phone book/Call History Auto Download
 - Bluetooth® Wireless Technology device auto connection

(Continued)

(Continued)

- Bluetooth® Wireless Technology Audio
- Before using Bluetooth® Wireless Technology related features of the audio system, refer your phone's User's Manual for phone-side Bluetooth® Wireless Technology operations.
- The phone must be paired to the audio system to use Bluetooth® Wireless Technology related features.
- Pairing and connecting a Bluetooth® Wireless Technology enabled mobile phone will work only when the Bluetooth® Wireless Technology option within your mobile phone has been turned on. (Methods of turning on the Bluetooth® Wireless Technology enabled feature may differ depending on the mobile phone.)
- Do not use a cellular phone or perform Bluetooth® Wireless Technology settings (e.g. pairing a phone) while driving.

(Continued)

(Continued)

- Even if the phone supports Bluetooth® Wireless Technology, the phone will not be found during device searches if the phone has been set to hidden state or the Bluetooth® Wireless Technology power is turned off. Disable the hidden state or turn on the Bluetooth® Wireless Technology power prior to searching/connecting with the car audio system.
- You will not be able to use the hands-free feature when your phone (in the car) is outside of the cellular service area (e.g. in a tunnel, in a underground, in a mountainous area, etc.).
- If the cellular phone signal is poor or the vehicles interior noise is too loud, it may be difficult to hear the other person's voice during a call.
- Do not place the phone near or inside metallic objects, otherwise communications with Bluetooth® Wireless Technology system or cellular service stations can be disturbed.

(Continued)

(Continued)

- Placing the audio system within an electromagnetic environment may result in noise interference.
- Some cellular phones or other devices may cause interference noise or malfunction to audio system. In this case, store the device in a different location may resolve the condition.
- While a phone is connected through *Bluetooth*[®] Wireless Technology your phone may discharge quicker than usual for additional *Bluetooth*[®] Wireless Technology-related operations.
- If Priority is set upon vehicle ignition (IGN/ACC ON), the *Bluetooth*[®] Wireless Technology phone will be automatically connected. Even if you are outside, the *Bluetooth*[®] Wireless Technology phone will be automatically connected once you are in the vicinity of the vehicle. If you do not want to automatically connect your *Bluetooth*[®] Wireless Technology phone, try the following.
 - 1) Turn off the *Bluetooth*[®] Wireless Technology feature in your mobile phone.

(Continued)

(Continued)

- 2) Turn off the *Bluetooth*[®] Wireless Technology feature in your car audio system.
 - To turn off the *Bluetooth*[®] Wireless Technology feature in your car audio system, go to [SETUP/CLOCK] > [Phone] and [turn off] the *Bluetooth*[®] Wireless Technology feature.
- *Bluetooth*[®] Wireless Technology connection may become intermittently disconnected in some mobile phones. Follow these steps to try again.
 - 1) Turn the *Bluetooth*[®] Wireless Technology function within the mobile phone off/on and try again.
 - 2) Turn the mobile phone power Off/On and try again.
 - 3) Completely remove the mobile phone battery, reboot, and then again.
 - 4) Reboot the audio system and try again.
 - 5) Delete all paired devices, pair and try again.

(Continued)

(Continued)

- It is possible to pair up to five *Bluetooth*[®] Wireless Technology devices to the car system.
- Phone contact names should be saved in English or they may not be displayed correctly.
- The Handsfree call volume and quality may differ depending on the mobile phone.
- Only one *Bluetooth*[®] Wireless Technology device can be connected at a time.
- In some mobile phones, starting the ignition while talking through *Bluetooth*[®] Wireless Technology enabled handsfree call will result in the call becoming disconnected. (Switch the call back to your mobile phone when starting the ignition.)
- If the mobile phone is not paired or connected, it is not possible to enter Phone mode. Once a phone is paired or connected, the guidance screen will be displayed.

NOTICE

- **Bluetooth® Wireless Technology Handsfree** is a feature that enables drivers to practice safe driving. Connecting the car audio system with a **Bluetooth® Wireless Technology** phone allows the user to conveniently make calls, receive calls, and manage the phone book. Before using the **Bluetooth® Wireless Technology**, carefully read the contents of this user's manual.
- **Excessive use or operations while driving may lead to negligent driving practices and be the cause of accidents.**
- **Do not operate the device excessively while driving.**
- **Viewing the screen for prolonged periods of time is dangerous and may lead to accidents.**
- **When driving, view the screen only for short periods of time.**

Radio Mode (Type A-1, Type A-2, Type A-3, Type A-4 with RDS)

With the Radio Mode Button



SEEK

Press the **[SEEK TRACK]** button.

- **Shortly pressing the button :** Changes the frequency.
- **Pressing and holding the button :** Automatically searches for the next frequency.

Preset SEEK

Press the **[1] ~ [6]** button.

- **Shortly pressing the button :** Plays the frequency saved in the corresponding button.
- **Pressing and holding the button :** Pressing and holding the desired button from **[1] ~ [6]** will save the currently playing broadcast to the selected button and sound a BEEP.

SCAN

Press the **[TA/SCAN]** button.

- **Pressing and holding the button :** The broadcast frequency increases and previews each broadcast for 5 seconds each. After scanning all frequencies, returns and plays the current broadcast frequency.

Selecting through manual search

Turn the **TUNE** knob left/right to adjust the frequency.

Traffic Announcement (TA)

Shortly pressing the **[TA/SCAN]** button : Set [On/Off] TA (Traffic Announcement) mode.

MENU : Radio



Within **[MENU]** button are the AST (Auto Store) and Info functions.

AST (Auto Store) : [1] Button

Select AST (Auto Store) to save frequencies with superior reception to presets **[1]** ~ **[6]**. If no frequencies are received, then the most recently received frequency will be broadcast.

Saves only to the Preset memory **[1]** ~ **[6]** of FMA or AMA mode.

AF (Alternative Frequency) : [2] Button

The Alternative Frequency option can be turned On/Off.

Region : [3] Button

The Region option can be turned On/Off.

News : [4] Button

The News option can be turned On/Off.

Radio Mode (Type A-5, Type A-6)

With the Radio Mode Button



SEEK

Press the **[SEEK TRACK]** button

- Shortly pressing the button : Changes the frequency.
- Pressing and holding the button : Automatically searches for the next frequency.

Preset SEEK

Press the **[1] ~ [6]** button

- Shortly pressing the button : Plays the frequency saved in the corresponding button.
- Pressing and holding the button : Pressing and holding the desired button from **[1] ~ [6]** will save the currently playing broadcast to the selected button and sound a BEEP.

SCAN

Press the **[SCAN]** button

- Shortly pressing the button : The broadcast frequency increases and previews each broadcast for 5 seconds each. After scanning all frequencies, returns and plays the current broadcast frequency.
- Pressing and holding the button : Previews the broadcasts saved in Preset **[1] ~ [6]** for 5 seconds each.

Selecting through manual search

Turn the **TUNE** knob left/right to adjust the frequency.

MENU : Radio



Within **[MENU]** button is the A.Store (Auto Store).

A.Store (Auto Store) : [1] Button

Select A.Store(Auto Store) to save frequencies with superior reception to presets **[1] ~ [6]**. If no frequencies are received, then the most recently received frequency will be broadcast.

Media Mode

With the Media Mode Button

Press the **[MEDIA]** button to change the mode in order of CD → USB(iPod®) → AUX → My Music* → BT Audio*.

*if equipped

The folder/file name is displayed on the screen.

■ Audio CD Mode

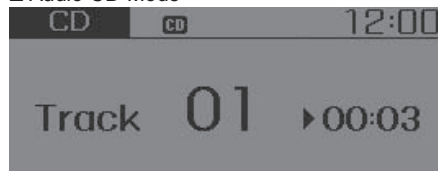

■ MP3 CD Mode

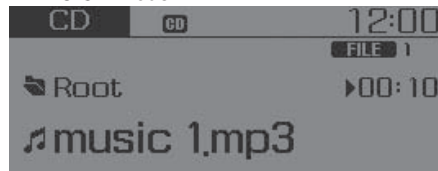

■ USB Mode

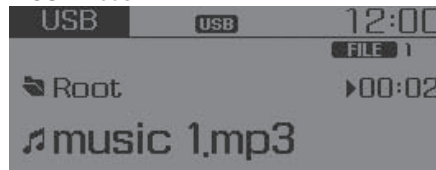

■ My Music Mode

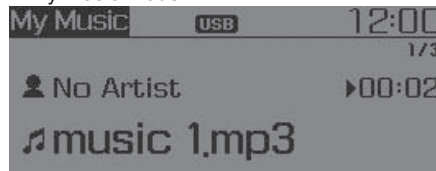

The CD is automatically played when a CD is inserted.

The USB music is automatically played when a USB is connected.

Repeat

While song (file) is playing ▶ **[RPT]** button

Audio CD, MP3 CD, USB, iPod®, My Music* mode : RPT on screen

- To repeat one song (Shortly pressing the button) : Repeats the current song.

MP3 CD, USB mode : FLD.RPT on screen

- To repeat folder (pressing twice) : repeats all files within the current folder.

Press the **[RPT]** button again to turn off repeat.

*if equipped

Random

While song (file) is playing ► **[RDM]** button

Audio CD, My Music* mode : RDM on screen

- Random (Shortly pressing the button) : Plays all songs in random order.

MP3 CD, USB mode : FLD.RDM on screen

- Folder Random (Shortly pressing the button) : Plays all files within the current folder in random order.

MP3 CD, USB mode : ALL RDM on screen

- Random (pressing twice) : Plays all files in random order.

iPod® mode : RDM on screen

- Random (Shortly pressing the button) : Plays all files in random order.

Press the **[RDM]** button again to turn off random.

*if equipped

Changing Song/File

While song (file) is playing ► **[SEEK TRACK √]** button

- Shortly pressing the button : Plays the current song from the beginning.

If the **[SEEK TRACK √]** button is pressed again within 1 second, the previous song is played.

- Pressing and holding the button : Rewinds the song.

While song (file) is playing ► **[SEEK TRACK ∧]** button

- Shortly pressing the button : Plays the next song.
- Pressing and holding the button : Fast forwards the song.

Scan (With RDS)

- Pressing and holding the **[TA/SCAN]** button : Scans all songs for 10 seconds starting from the next song.
- Pressing and holding the **[TA/SCAN]** button again to turn off.
- The SCAN function is not supported in iPod® mode.

Scan (Without RDS)

- Shortly pressing the **[SCAN]** button : Scans all songs from the next song for 10 seconds each.
- Press the **[SCAN]** button again to turn off.
- The SCAN function is not supported in iPod® mode.

Folder Search (Only MP3 CD, USB mode)

While file is playing ► **[FOLDER ^]** button

- Searches the next folder.

While file is playing ► **[FOLDER v]** button

- Searches the parent folder.

If a folder is selected by pressing the **TUNE** knob, the first file within the selected folder will be played.

Searching Songs (File)

- Turning **TUNE** knob : Searches for songs (files).
- Pressing **TUNE** knob : Plays selected song (file).

MENU : Audio CD



Press the Audio CD mode **[MENU]** button to set the Repeat, Random, Information features.

Repeat : [1] Button

Repeat the current song.
Press RPT again to turn off.

Random : [2] Button

Randomly play songs within the CD.
Press RDM again to turn off.

Information : [3] Button

Display information of the current song.
Press the **[MENU]** button to turn off info display.

MENU : MP3 CD / USB



Press the MP3 CD / USB mode **[MENU]** button to set the Repeat, Folder Random, Folder Repeat, All Random, Information and Copy features.

Repeat : [1] Button

Repeat the current song.
Press RPT again to turn off.

Folder Random : [2] Button

Randomly play songs within the current folder.
Press F.RDM again to turn off.

Folder Repeat : [3] Button

Repeat songs within the current folder.

Press F.RPT again to turn off.

All Random : [4] Button

Randomly play all songs within the CD / USB.

Press A.RDM again to turn off.

Information : [5] Button

Display information of the current song.

Press the **[MENU]** button to turn off info display.

Copy : [6] Button (if equipped)

This is used to copy the current song into My Music. You can play the copied Music in My Music mode.

If another button is pressed while copying is in progress, a pop up asking you whether to cancel copying is displayed.

If another media is connected or inserted (USB, CD, iPod®, AUX) while copying is in progress, copying is canceled.

Music will not be played while copying is in progress.

MENU : iPod®



In iPod® mode, press the **[MENU]** button to set the Repeat, Random, Information and Search features.

Repeat : [1] Button

Repeat the current song.

Press RPT again to turn repeat off.

Random : [2] Button

Plays all songs within the currently playing category in random order.

Press RDM again to turn off.

Information : [3] Button

Displays information of the current song.

Press the **[MENU]** button to turn off info display.

Search : [4] Button

Displays iPod® category list.

Searching iPod® category is **[MENU]** button pressed, move to parent category.

MENU : AUX

■ Type A-1, Type A-2, Type A-3, Type A-4



■ Type A-5, Type A-6



AUX is used to play external MEDIA currently connected with the AUX terminal.

AUX mode will automatically start when an external device is connected with the AUX terminal.

If an external device is connected, you can also press the **[MEDIA]** button to change to AUX mode.

AUX mode cannot be started unless there is an external device connected to the AUX terminal.

i Information - Using the AUX

Fully insert the AUX cable into the AUX terminal for use.

MENU : My Music (if equipped)



In My Music mode, press the **[MENU]** button to set the Repeat, Random, Information, Delete, Delete All and Delete Selection features.

Repeat : [1] Button

Repeats the currently playing song. Press RPT again to turn repeat off.

Random : [2] Button

Plays all songs in random order. Press RDM again to turn random off.

Information : [3] Button

Displays information of the current song.

Press the **[MENU]** button to turn off info display.

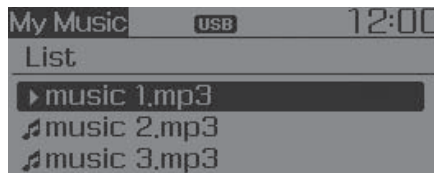

Delete : [4] Button

- Deletes currently playing file
In the play screen, pressing delete will delete the currently playing song.
 - Deletes file from list
- ① Select the file you wish to delete by using the **TUNE** knob.
 - ② Press the **[MENU]** button and select the delete menu to delete the selected file

Delete All : [5] Button

Deletes all songs of My Music.

Delete Selection : [6] Button

Songs within My Music are selected and deleted.

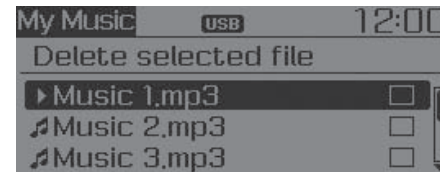

- ① Select the songs you wish to delete from the list.

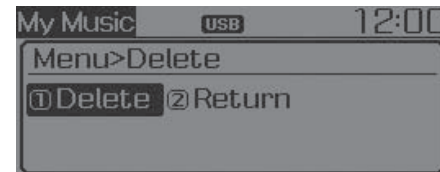

- ② After selecting, press the **[MENU]** button and select the delete menu.

i Information
- Using the My Music

- Even if memory is available, a maximum of 6,000 songs can be stored.
- The same song can be copied up to 1,000 times.
- Memory info can be checked in the System menu of Setup.

MENU : Bluetooth® Wireless Technology Audio (if equipped)

If BT Audio is selected, *Bluetooth®* Wireless Technology audio will start playing.

Audio may not automatically start playing in some mobile phones.



Play / Pause : Press the **TUNE** knob to play and pause the current song.

The previous song / next song / play / pause functions may not be supported in some mobile phones.

⚠ WARNING

Driving while distracted can result in a loss of vehicle control that may lead to an accident, severe personal injury, and death. The driver's primary responsibility is in the safe and legal operation of a vehicle, and use of any handheld devices, other equipment, or vehicle systems which take the driver's eyes, attention and focus away from the safe operation of a vehicle or which are not permissible by law should never be used during operation of the vehicle.

Phone Mode (if equipped)

Making a call using the Steering wheel controls

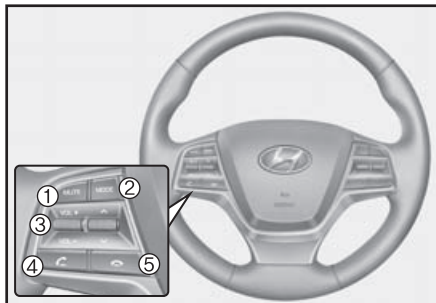

※ The actual features in the vehicle may differ from the illustration.

- (1) Mutes the microphone during a call.
- (2) Press the button to change audio source.

(With RDS)

FM1 → FM2 → FMA → AM → AMA →
 CD → USB(iPod®) → AUX → My
 Music → BT Audio.

(Without RDS)

FM1 → FM2 → AM → CD →
 USB(iPod®) → AUX → My Music →
 BT Audio.

- (3) Raises or lowers speaker volume.
- (4) Places and transfers calls.

- Check call history and making call
 - Shortly press the **[CALL]** button on the steering wheel controls.
 - The call history list will be displayed on the screen.
 - Press the **[CALL]** button again to connect a call to the selected number.
- Redialing the most recently called number

- Press and hold the **[CALL]** button on the steering wheel controls.
- The most recently called number is redialed.

- (5) Ends calls or cancels functions.

MENU : Phone (Type A-1, Type A-3)

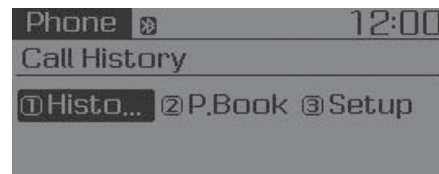

Press the **[PHONE]** button to display three menus (Call History, Phone Book, Phone Setup).

History : [1] Button

The call history is displayed and can be used to select a number and make a call.

If call history does not exist, a screen asking whether to download call history is displayed. (The download feature may not be supported in some mobile phones)

P.Book : [2] Button

The phone book is displayed and can be used to select a number and make a call.

If more than one number is saved to one phone book, then a screen showing the mobile phone number, Home and office number is displayed. Select the desired number to make the call.

If phone book does not exist, a screen asking whether to download phone book is displayed. (The download feature may not be supported in some mobile phones)

Setup : [3] Button

The *Bluetooth*[®] Wireless Technology mobile phone setup screen is displayed. For more information, refer to “Phone Setup”.

MENU : Phone (Type A-5)

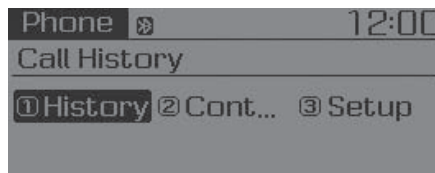

Press the [**PHONE**] button to display three menus (Call History, Contacts, Phone Setup).

History : [1] Button

The call history is displayed and can be used to select a number and make a call.

If call history does not exist, a screen asking whether to download call history is displayed. (The download feature may not be supported in some mobile phones)

Contacts : [2] Button

The contacts are displayed and can be used to select a number and make a call.

If more than one number is saved to one contact, then a screen showing the mobile phone number, Home and office number is displayed. Select the desired number to make the call.

If contacts do not exist, a screen asking whether to download contacts are displayed. (The download feature may not be supported in some mobile phones)

Setup : [3] Button

The *Bluetooth*[®] Wireless Technology mobile phone setup screen is displayed. For more information, refer to “Phone Setup”.

Setup Mode (Type A-1, Type A-2, Type A-3, Type A-4)

With the Display Button

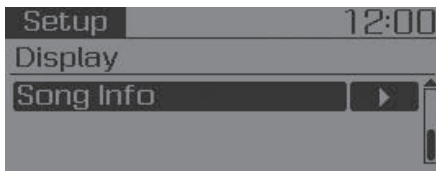
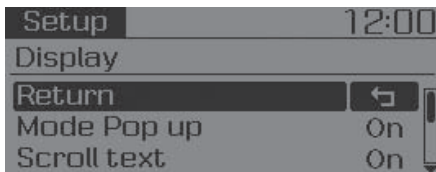

Press the **[SETUP/CLOCK]** button ►
Select [Display]

Mode Pop up

[Mode Pop up] ► Changes [On] selection mode

- During On state, press the **[RADIO]** or **[MEDIA]** button to display the mode change pop up screen.

Scroll text

[Scroll text] ► Set [On/Off]

- [On] : Maintains scroll
- [Off] : Scrolls only one (1) time.



Song Info

When playing an MP3 file, select the desired display info from 'Folder/File' or 'Album/Artist/Song'.

With the Sound Button



Press the **[SETUP/CLOCK]** button ►
Select [Sound]

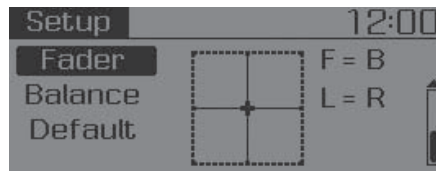

Audio Settings

This menu allows you to set the 'Bass, Middle, Treble' and the Sound Fader and Balance.

Select [Audio Settings] ► Select menu

- Return : While adjusting values, repressing the **TUNE** knob will restore the parent menu.
- Bass, Middle, Treble : Selects the sound tone.
- Fader, Balance : Moves the sound fader and balance.
- Default : Restores default settings.

Speed Dependent Volume Control

This feature is used to automatically control the volume level according to the speed of the vehicle.

Select [Speed Dependent Vol.] ► Set [Off/On]

With the Clock Button

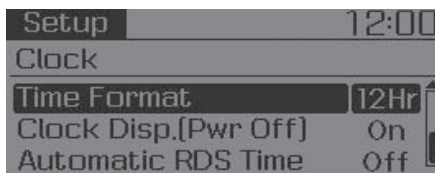
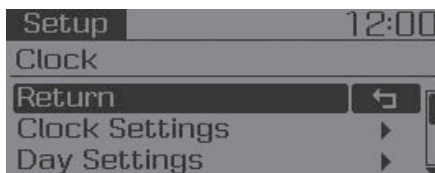

Press the [**SETUP/CLOCK**] button ► Select [Clock]



Clock Settings

This menu is used to set the time.

Select [Clock Settings]

Adjust the number currently in focus to set the [hour] and press the **TUNE** knob to set the [minute].

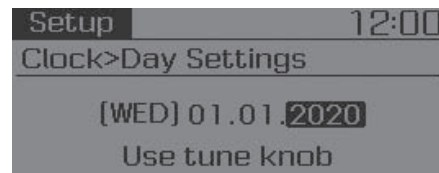

Day Settings

This menu is used to set the date.

Select [Day Settings]

Adjust the number currently in focus to make the settings and press the **TUNE** knob to move to the next setting.

Time Format

This function is used to set the 12/24 hour time format of the audio system.

Select [Time Format] ► Set 12hr/24hr.

Clock Display when Power is OFF

Select [Clock Disp.(Pwr Off)] ► Set [On/Off]

- [On] : Displays time/date on screen
- [Off] : Turn off.

Automatic RDS Time (With RDS)

This option is used to automatically set the time by synchronizing with RDS.

Select [Automatic RDS Time] ► Set [On/Off]

- [On] : Turn on Automatic Time
- [Off] : Turn off.

i Information

Because some local radio stations do not support an automatic RDS time function, some RDS Transmitters may not provide correct time.

If incorrect time is displayed, set it manually following the Step “Clock Settings” in previous page.

With the Phone Button (if equipped)

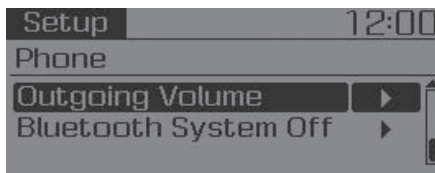
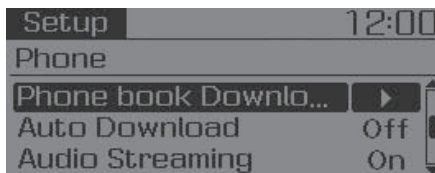
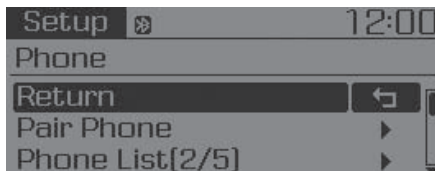

Press the [SETUP/CLOCK] button ►
Select [Phone]

NOTICE

To pair a **Bluetooth®** Wireless Technology enabled mobile phone, authentication and connection processes are first required. As a result, you cannot pair your mobile phone while driving the vehicle. First park your vehicle before use.

Pair Phone

Select [Pair Phone]

- ① Search for device names as displayed on your mobile phone and connect.

* SSP : Secure Simple Pairing

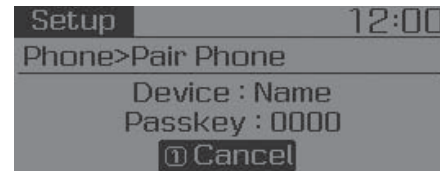

Non SSP supported device :

- ② After a few moments, a screen is displayed where the passkey is entered.

Enter the passkey "0000" to pair your *Bluetooth*[®] Wireless Technology device with the car audio system.

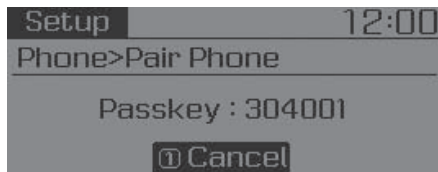

SSP supported device :

- ② After a few moments, a screen is displayed 6 digits passkey. Check the passkey on your *Bluetooth*[®] Wireless Technology device and confirm.

The device name and passkey will be displayed on the screen for up to 3 minutes. If pairing is not completed within the 3 minutes, the mobile phone pairing process will automatically be canceled.

- ③ Pairing completion is displayed.

In some mobile phones, pairing will automatically be followed by connection.

It is possible to pair up to five *Bluetooth*[®] Wireless Technology enabled mobile phones.

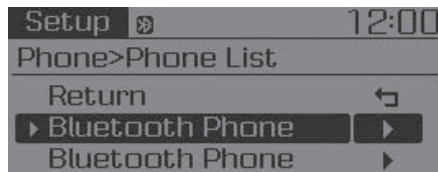

Phone List

The names of up to 5 paired phones will be displayed.

A [▶] is displayed in front of the currently connected phone.

Select the desired name to setup the selected phone.

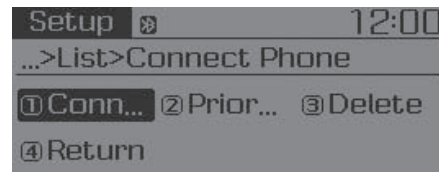

• Connecting a phone

Select [Phone List] ▶ Select mobile phone ▶ Select [Connect Phone]

- ① Select a mobile phone that is not currently connected.
- ② Connect the selected mobile phone.
- ③ Connection completion is displayed.

If a phone is already connected, disconnect the currently connected phone and select a new phone to connect.

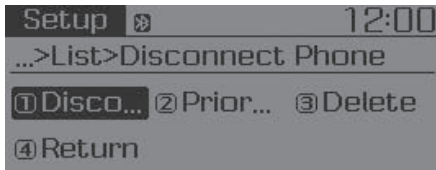

- Disconnecting a connected phone
Select [Phone List] ► Select mobile phone ► Select [Disconnect Phone]
 - ① Select the currently connected mobile phone.
 - ② Disconnect the selected mobile phone.
 - ③ Disconnection completion is displayed.

- Changing connection sequence (Priority)

This is used to change the order (priority) of automatic connection for the paired mobile phones.

Select [Phone List] ► Select [Priority] ► Select No. 1 Priority mobile phone

- ① Select [Priority].
- ② From the paired phones, select the phone desired for No.1 priority.
- ③ The changed priority sequence is displayed.

Once the connection sequence (priority) is changed, the new no. 1 priority mobile phone will be connected.

When the no. 1 priority cannot be connected : Automatically attempts to connect the most recently connected phone.

Cases when the most recently connected phone cannot be connected : Attempts to connect in the order in which paired phones are listed.

The connected phone will automatically be changed to No. 1 priority.

- Delete

Select [Phone List] ► Select mobile phone ► Select [Delete]

- ① Select the desired mobile phone.
- ② Delete the selected mobile phone.
- ③ Deletion completion is displayed.

When attempting to delete a currently connected phone, the phone is first disconnected.

NOTICE

- **When you delete a mobile phone, the mobile phone phone book will also be erased.**
- **For stable Bluetooth® Wireless Technology communication, delete the mobile phone from the audio and also delete the audio from your mobile phone.**

Phone book Download

This feature is used to download phone book and call histories into the audio system.

Select [Phone book Download]

NOTICE

- **The download feature may not be supported in some mobile phones.**
- **When downloading new phone book, delete all previously saved phone book before starting download.**

Auto Download

When connecting a mobile phone, it is possible to automatically download new phone book and Call Histories.

Select [Auto Download] ► Set [On/Off]

Outgoing Volume

This is used to set the volume of your voice as heard by the other party while on a *Bluetooth®* Wireless Technology enabled handsfree call.

Select [Outgoing Volume] ► Set volume

Even while on a call, the volume can be changed by using the [SEEK TRACK] button.

Bluetooth System Off

This feature is used when you do not wish to use the *Bluetooth®* Wireless Technology system.

Select [Bluetooth System Off].

If a phone is already connected, disconnect the currently connected phone and turn the *Bluetooth®* Wireless Technology system off.

Using the *Bluetooth®* Wireless Technology

To use *Bluetooth®* Wireless Technology when the system is currently off, follow these next steps.

- Turning On *Bluetooth®* Wireless Technology through the [PHONE] button.

Press the [PHONE] button ► Screen Guidance

Moves to the screen where *Bluetooth®* Wireless Technology functions can be used and displays guidance.

- Turning On *Bluetooth®* Wireless Technology through the [SETUP/CLOCK] button.

Press the [SETUP/CLOCK] button ► Select [Phone]

- ① A screen asking whether to turn on *Bluetooth®* Wireless Technology will be displayed.
- ② On the screen, select [YES] to turn on *Bluetooth®* Wireless Technology and display guidance.

If the *Bluetooth®* Wireless Technology system is turned on, the system will automatically try to connect the most recently connected *Bluetooth®* Wireless Technology mobile phone.

With the System Button

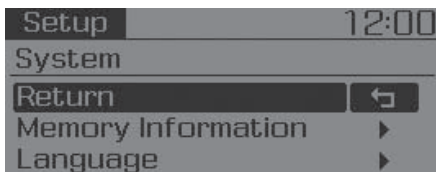

Press the **[SETUP/CLOCK]** button ►
Select [System]



Memory Information (if equipped)

Displays currently used memory and total system memory.

Select [Memory Information] ► OK

The currently used memory is displayed on the left side while the total system memory is displayed on the right side.

* May differ depending on the selected audio.

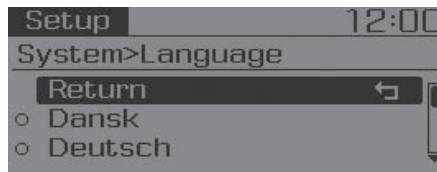

Language

This menu is used to set the display and voice recognition language.

Select [Language]

The system will reboot after the language is changed.

- Language support by region
Dansk, Deutsch, English(UK), Español, Français, Italiano, Nederlands, Русский, Polski, Svenska, Türkçe.

Setup Mode (Type A-5, Type A-6)

With the Display Button

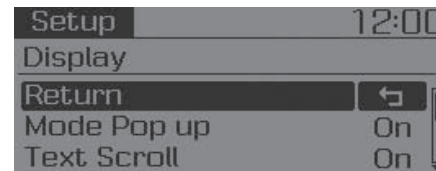

Press the **[SETUP/CLOCK]** button ►
Select [Display]

Mode Pop up

[Mode Pop up] ► Changes [On] selection mode

- During On state, press the **[RADIO]** or **[MEDIA]** button to display the mode change pop up screen.

Text Scroll

[Text Scroll] ► Set [On/Off]

- [On] : Maintains scroll
- [Off] : Scrolls only one (1) time.



Media Display

When playing an MP3 file, select the desired display info from 'Folder/File' or 'Album/Artist/Song'.

With the Sound Button



Press the [SETUP/CLOCK] button
► Select [Sound]

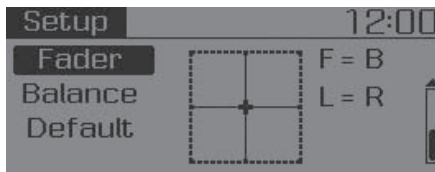

Sound Settings

This menu allows you to set the 'Bass, Middle, Treble' and the Sound Fader and Balance.

Select [Sound Settings] ► Select menu

- Return : While adjusting values, re-pressing the **TUNE** knob will restore the parent menu.
- Bass, Middle, Treble : Selects the sound tone.
- Fader, Balance : Moves the sound fader and balance.
- Default : Restores default settings.

Speed Dependent Volume Control

This feature is used to automatically control the volume level according to the speed of the vehicle.

Select [Speed Dependent Vol.] ► Set [Off/On]

With the Clock Button

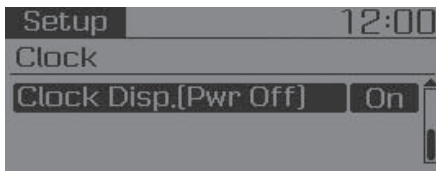
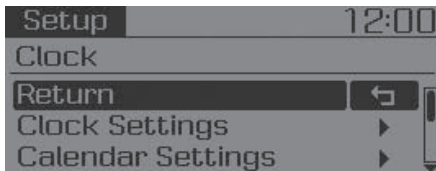

Press the **[SETUP/CLOCK]** button ►
Select [Clock]



Clock Settings

This menu is used to set the time.

Select [Clock Settings]

Adjust the number currently in focus to set the [hour] and press the **TUNE** knob to set the [minute].

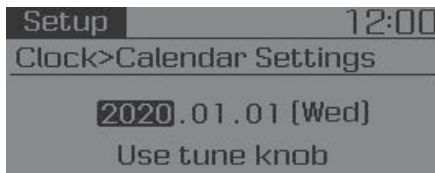

Calendar Settings

This menu is used to set the date.

Select [Calendar Settings]

Adjust the number currently in focus to make the settings and press the **TUNE** knob to move to the next setting.

Clock Display when Power is OFF

Select [Clock Disp.(Pwr Off)] ► Set [On/Off]

- [On] : Displays time/date on screen
- [Off] : Turn off.

With the Phone Button (if equipped)

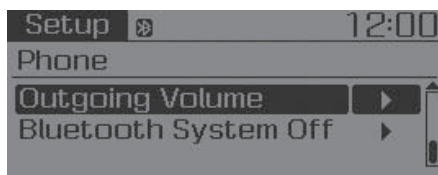
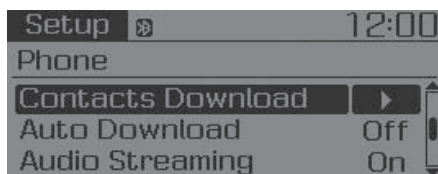
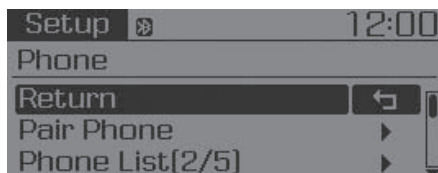

Press the [SETUP/CLOCK] button ►
Select [Phone]

NOTICE

To pair a **Bluetooth®** Wireless Technology enabled mobile phone, authentication and connection processes are first required. As a result, you cannot pair your mobile phone while driving the vehicle. First park your vehicle before use.

Pair Phone

Select [Pair Phone]

- ① Search for device names as displayed on your mobile phone and connect.

* SSP : Secure Simple Pairing

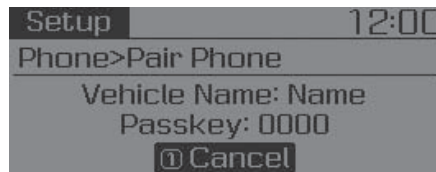

Non SSP supported device :

- ② After a few moments, a screen is displayed where the passkey is entered.

Enter the passkey “0000” to pair your **Bluetooth®** Wireless Technology device with the car audio system.

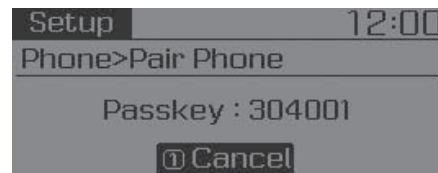

SSP supported device :

- ② After a few moments, a screen is displayed 6 digits passkey.

Check the passkey on your **Bluetooth®** Wireless Technology device and confirm.

The device name and passkey will be displayed on the screen for up to 3 minutes. If pairing is not completed within the 3 minutes, the mobile phone pairing process will automatically be canceled.

- ③ Pairing completion is displayed.

In some mobile phones, pairing will automatically be followed by connection.

It is possible to pair up to five **Bluetooth®** Wireless Technology enabled mobile phones.

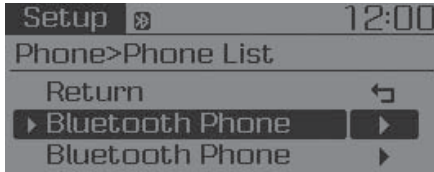

Phone List

The names of up to 5 paired phones will be displayed.

A [▶] is displayed in front of the currently connected phone.

Select the desired name to setup the selected phone.



- Connecting a phone

Select [Phone List] ▶ Select mobile phone ▶ Select [Connect Phone]

- ① Select a mobile phone that is not currently connected.
- ② Connect the selected mobile phone.
- ③ Connection completion is displayed.

If a phone is already connected, disconnect the currently connected phone and select a new phone to connect.

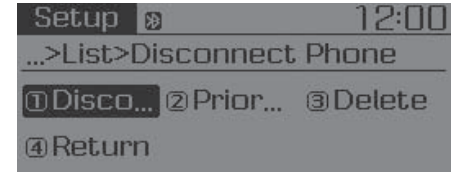

- Disconnecting a connected phone

Select [Phone List] ▶ Select mobile phone ▶ Select [Disconnect Phone]

- ① Select the currently connected mobile phone.
- ② Disconnect the selected mobile phone.
- ③ Disconnection completion is displayed.

- Changing connection sequence (Priority)

This is used to change the order (priority) of automatic connection for the paired mobile phones.

Select [Phone List] ► Select [Priority] ► Select No. 1 Priority mobile phone

- ① Select [Priority].
- ② From the paired phones, select the phone desired for No.1 priority.
- ③ The changed priority sequence is displayed.

Once the connection sequence (priority) is changed, the new no. 1 priority mobile phone will be connected.

When the no. 1 priority cannot be connected: Automatically attempts to connect the most recently connected phone.

Cases when the most recently connected phone cannot be connected: Attempts to connect in the order in which paired phones are listed.

The connected phone will automatically be changed to No. 1 priority.

- Delete

Select [Phone List] ► Select mobile phone ► Select [Delete]

- ① Select the desired mobile phone.
- ② Delete the selected mobile phone.
- ③ Deletion completion is displayed.

When attempting to delete a currently connected phone, the phone is first disconnected.

NOTICE

- **When you delete a mobile phone, the mobile phone contacts will also be erased.**
- **For stable *Bluetooth®* Wireless Technology communication, delete the mobile phone from the audio and also delete the audio from your mobile phone.**

Contacts Download

This feature is used to download contacts and call histories into the audio system.

Select [Contacts Download]

NOTICE

- **The download feature may not be supported in some mobile phones.**
- **When downloading new Contacts, delete all previously saved Contacts before starting download.**

Auto Download

When connecting a mobile phone, it is possible to automatically download new Contacts and Call Histories.

Select [Auto Download] ► Set [On/Off]

Outgoing Volume

This is used to set the volume of your voice as heard by the other party while on a *Bluetooth*® Wireless Technology enabled handsfree call.

Select [Outgoing Volume] ► Set volume

While on a call, the volume can be changed by using the **[SEEK TRACK]** button.

Bluetooth System Off

This feature is used when you do not wish to use the *Bluetooth*® Wireless Technology system.

Select [Bluetooth System Off]

If a phone is already connected, disconnect the currently connected phone and turn the *Bluetooth*® Wireless Technology system off.

Using the *Bluetooth*® Wireless Technology

To use *Bluetooth*® Wireless Technology when the system is currently off, follow these next steps.

- Turning On *Bluetooth*® Wireless Technology through the **[PHONE]** button

Press the **[PHONE]** button ► Screen Guidance

Moves to the screen where *Bluetooth*® Wireless Technology functions can be used and displays guidance.

- Turning On *Bluetooth*® Wireless Technology through the **[SETUP/CLOCK]** button

Press the **[SETUP/CLOCK]** button ► Select [Phone]

- ① A screen asking whether to turn on *Bluetooth*® Wireless Technology will be displayed.
- ② On the screen, select [YES] to turn on *Bluetooth*® Wireless Technology and display guidance.

If the *Bluetooth*® Wireless Technology system is turned on, the system will automatically try to connect the most recently connected *Bluetooth*® Wireless Technology mobile phone.

With the System Button

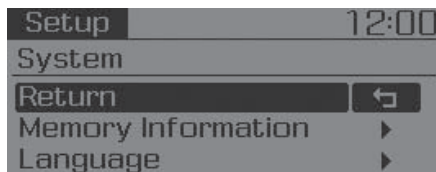

Press the **[SETUP/CLOCK]** button ►
Select **[System]**

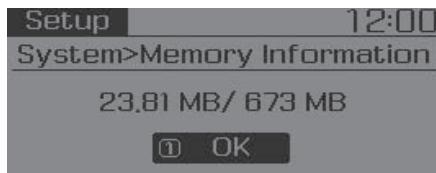

Memory Information (if equipped)

Displays currently used memory and total system memory.

Select **[Memory Information]** ► **OK**

The currently used memory is displayed on the left side while the total system memory is displayed on the right side.

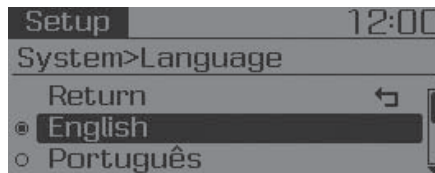

Language

This menu is used to set the display.

Select **[Language]**

The system will reboot after the language is changed.

- Language support by region.
English, Português, Español

AUDIO (With Touch Screen)

■ Type B-1



■ Type B-2



(With *Bluetooth*® Wireless Technology)

ADB5000EE/ADB5001EE

Feature of Your Audio



(1) EJECT

- Ejects the disc.

(2) RADIO

- Changes to FM/AM mode.
- Each time the button is pressed, the mode is changed in order of FM1 → FM2 → FMA → AM → AMA.

(3) MEDIA

- Changes to CD, USB(iPod®), AUX, My Music, BT Audio mode.
- Each time the button is pressed, the mode is changed in order of CD, USB(iPod®), AUX, My Music, BT Audio.

(4) PHONE

- Converts to Phone mode.
- When a phone is not connected, the connection screen is displayed.

(5) POWER/VOLUME knob

- Power knob : Turns power On/Off by pressing the knob
- Volume knob : Sets volume by turning the knob left/right

(6) SEEK TRACK

When pressed shortly

- Radio mode : plays previous/next frequency.
- CD, USB, iPod®, My Music, BT Audio mode : changes the track, Song(file).

When pressed and held

- Radio mode : continuously changes the frequency. Upon release, plays the current frequency.
- CD, USB, iPod®, My Music mode : rewinds or fast forwards the track or file.
- During a Handsfree call, controls the call volume.



(7) **DISP**

- Each time the button is shortly pressed, sets Screen Off → Screen On → Screen Off
- Audio operation is maintained and only the screen will be turned Off.
- In the Screen Off state, press any button to turn the Screen On again.

(8) **CLOCK**

- Displays the time/date/day.

(9) **TA/SCAN**

- Radio mode
 - Shortly press the button : TA On/Off
 - Press and hold the button : Previews each broadcast for 5 seconds each.
- CD, USB, My Music mode
 - Press and hold the button : Previews each song (file) for 10 seconds each.
 - Press and hold the button again to continue listening to the current song (file).

(10) **SETUP**

- Converts to Setup mode.

(11) **TUNE** knob

- Radio mode : turn to change broadcast frequencies.
- CD, USB, iPod®, My Music mode : turn to search tracks/channels/files.

(12) **FOLDER**

- MP3 CD/USB mode : Folder Search

■ Type B-3



■ Type B-4



(With *Bluetooth*® Wireless Technology)

ADB50002EE/ADB50003EE

Feature of Your Audio



(1) **EJECT**

- Ejects the disc.

(2) **RADIO**

- Changes to FM/AM mode.
- Each time the button is pressed, the mode is changed in order of FM1 → FM2 → FMA → AM → AMA.

(3) **MEDIA**

- Changes to CD, USB(iPod®), AUX, My Music, BT Audio mode.
- Each time the button is pressed, the mode is changed in order of CD, USB(iPod®), AUX, My Music, BT Audio.

(4) **PHONE**

- Converts to Phone mode.
- When a phone is not connected, the connection screen is displayed.

(5) **PWR/VOL** knob

- Power knob : Turns power On/Off by pressing the knob
- Volume knob : Sets volume by turning the knob left/right

(6) **SEEK TRACK**

When pressed shortly

- Radio mode : plays previous/next frequency.
- CD, USB, iPod®, My Music, BT Audio mode : changes the track, Song(file).

When pressed and held

- Radio mode : continuously changes the frequency. Upon release, plays the current frequency.
- CD, USB, iPod®, My Music mode : rewinds or fast forwards the track or file.
- During a Handsfree call, controls the call volume.



(7) **DISP**

- Each time the button is shortly pressed, sets Screen Off → Screen On → Screen Off
- Audio operation is maintained and only the screen will be turned Off.
- In the Screen Off state, press any button to turn the Screen On again.

(8) **CLOCK**

- Displays the time/date/day.

(9) **TA/SCAN**

- Radio mode
 - Shortly press the button : TA On/Off
 - Press and hold the button : Previews each broadcast for 5 seconds each.
- CD, USB, My Music mode
 - Press and hold the button : Previews each song (file) for 10 seconds each.
 - Press and hold the button again to continue listening to the current song (file).

(10) **SETUP**

- Converts to Setup mode.

(11) **TUNE** knob

- Radio mode : turn to change broadcast frequencies.
- CD, USB, iPod®, My Music mode : turn to search tracks/channels/files.

(12) **FOLDER**

- MP3 CD/USB mode : Folder Search

■ Type B-5



■ Type B-6



(With *Bluetooth*® Wireless Technology)

ADB50004EE/ADB50005EE

Feature of Your Audio



(1) EJECT

- Ejects the disc.

(2) RADIO

- Changes to FM/AM mode.
- Each time the button is pressed, the mode is changed in order of FM1 → FM2 → AM.

(3) MEDIA

- Changes to CD, USB(iPod®), AUX, My Music, BT Audio mode.
- Each time the button is pressed, the mode is changed in order of CD, USB(iPod®), AUX, My Music, BT Audio.

(4) PHONE

- Converts to Phone mode.
- When a phone is not connected, the connection screen is displayed.

(5) PWR/VOL knob

- Power knob : Turns power On/Off by pressing the knob
- Volume knob : Sets volume by turning the knob left/right

(6) SEEK TRACK

When pressed shortly

- Radio mode : plays previous/next frequency.
- CD, USB, iPod®, My Music, BT Audio mode : changes the track, Song(file).

When pressed and held

- Radio mode : continuously changes the frequency. Upon release, plays the current frequency.
- CD, USB, iPod®, My Music mode : rewinds or fast forwards the track or file.
- During a Handsfree call, controls the call volume.



(7) **DISP**

- Each time the button is shortly pressed, sets Screen Off → Screen On → Screen Off
- Audio operation is maintained and only the screen will be turned Off.
- In the Screen Off state, press any button to turn the Screen On again.

(8) **CLOCK**

- Displays the time/date/day.

(9) **SCAN**

- Radio mode : previews all receivable broadcasts for 5 seconds each.
- CD, USB, My Music mode : previews each song (file) for 10 seconds each.

(10) **SETUP**

- Converts to Setup mode.

(11) **TUNE** knob

- Radio mode : turn to change broadcast frequencies.
- CD, USB, iPod®, My Music mode : turn to search tracks/channels/files.

(12) **FOLDER**

- MP3 CD/USB mode : Folder Search

i Information**- Using the Discs**

- This device has been manufactured to be compatible with software bearing the following logo marks.
- Do not clean discs with chemical solutions, such as record sprays, antistatic sprays, antistatic liquids, benzene, or thinners.
- After using a disc, put the disc back in its original case to prevent disc scratches.
- Hold discs by their edges or within the center hole to prevent damages to disc surfaces.
- Do not introduce foreign substances into the disc insert/eject slot. Introducing foreign substances could damage the device interior.
- Do not insert two discs simultaneously.
- When using CD-R/CD-RW discs, differences in disc reading and playing times may occur depending on the disc manufacturer, production method and the recording method as used by the user.

(Continued)

(Continued)

- Clean fingerprints and dust off the disc surface (coated side) with a soft cloth.
- The use of CD-R/CD-RW discs attached with labels may result in disc slot jams or difficulties in disc removal. Such discs may also result in noise while playing.
- Some CD-R/CD-RW discs may not properly operate depending on the disc manufacturer, production method and the record method as used by the user. If problems persist, trying using a different CD as continued use may result in malfunctions.
- The performance of this product may differ depending on the CDRW Drive Software.
- Copy-protected CDs such as Stype CDs may not function in the device. DATA discs cannot be played. (However, such discs may still operate but will do so abnormally.)

(Continued)

(Continued)

- Do not use abnormally shaped discs (8cm, heart-shaped, octagonshaped) as such discs could lead to malfunctions.
- If the disc is straddled on the disc slot without removal for 10 seconds, the disc will automatically be re-inserted into the disc player.
- Only genuine audio CDs are supported. Other discs may result in recognition failure (e.g. copy CDR, CDs with labels)

MP3 File Information

• Supported Audio Formats

File System	ISO 9660 Level 1
	ISO 9660 Level 2
	Romeo / Juliet (128 characters)
Audio Compression	MPEG1 Audio Layer3
	MPEG2 Audio Layer3
	MPEG2.5 Audio Layer3
	Windows Media Audio Ver 7.X & 8.X

* File formats that do not comply with the above formats may not be properly recognized or play without properly displaying file names or other information.

• Support for Compressed Files

1. Supported Bitrates (Kbps)

	MPEG1	MPEG2	MPEG2.5	WMA
BIT RATE(kbps)	Layer3	Layer3	Layer3	High Range
	32	8	8	48
	40	16	16	64
	48	24	24	80
	56	32	32	96
	64	40	40	128
	80	48	48	160
	96	56	56	192
	112	64	64	
	128	80	80	
	160	96	96	
	192	112	112	
	224	128	128	
	256	144	144	
	320	160	160	

• For MP3/WMA compression files, differences in sound quality will occur depending on the bitrate. (Higher sound quality can be experienced with higher bitrates.)

• This device only recognizes files with MP3/WMA extensions. Other file extensions may not be properly recognized.

3. Maximum number of recognized folders and files

- Folder : 255 folders for CD, 2,000 folders for USB
- File : 999 files for CD, 6,000 files for USB

* There are no limitations to the number of recognized folder levels

2. Sampling Frequencies (Hz)

MPEG1	MPEG2	MPEG2.5	WMA
44100	22050	11025	32000
48000	24000	12000	44100
3000	16000	8000	48000

- Language Support (Unicode Support)
 1. English : 94 characters
 2. Special characters and Symbols : 986 characters
 - ✧ Languages other than Korean and English (including Chinese) are not included.
 - 3. Text Display (Based on Unicode)
 - File name : Maximum 64 English characters
 - Folder name : Max 32 English characters
 - ✧ Using the scroll feature allows you to see the entire name of files with names that are too long to be displayed at once.
- Compatibility by Disc Type
 1. Playing MIXED CDs : First plays the audio CD, then plays the compressed file(s).
 2. Playing EXTRA CDs : First plays the audio CD, then plays the compressed file(s).
 3. Playing multisession CDs : Plays in order of sessions
 - MIXED CD : CD type in which both MP3 and audio CD files are recognized in one disc.
 - Multisession CD CD type that includes more than two sessions. Different from Extra CDs, multisession CDs are recorded by sessions and have no media limitation.
- Precautions upon Writing CDs
 1. In all cases except when creating multisession discs, check the close session option before creating the disc. Though product malfunctions will not occur, some time may be required for the device to check whether the session state is closed (approximately 25 seconds). (Additional time may also be required depending on the number of folders or files.)
 2. Changing the MP3/WMA file extensions or changing files of other extensions to MP3/WMA may result in product malfunction.
 3. When naming files with MP3/WMA file extensions, write using only Korean and English. (Languages other than Korean and English are not supported and are displayed as blank.)
 4. Unauthorized use or duplication of music files are prohibited by law.
 5. Prolonged use of CD-R/CD-RW discs that do not satisfy related standards and/or specifications could result in product malfunction.

i Information

- Using the USB Device

- Connect the USB device after turning on the engine. The USB device may become damaged if it is already connected when the ignition is turned on. The USB device may not operate properly if the car ignition is turned on or off with the USB device connected.
- Heed caution to static electricity when connecting/disconnecting USB devices.
- Encoded MP3 Players will not be recognized when connected as an external device.
- When connecting an external USB device, the device may not properly recognize the USB is in some states.
- Only products formatted with byte/sectors under 64Kbyte will be recognized.
- This device recognizes USB devices formatted in FAT 12/16/32 file formats. This device does not recognize files in NTFS file format.

(Continued)

(Continued)

- Some USB devices may not be supported due to compatibility issues.
- Avoid contact between the USB connector with bodily parts or foreign objects.
- Repeated connecting/disconnecting of USB devices within short periods of time may result in product malfunction.
- A strange noise may occur when disconnecting the USB.
- Make sure to connect/disconnect external USB devices with the audio power turned off.
- The amount of time required to recognize the USB device may differ depending on the type, size or file formats stored in the USB. Such differences in time are not indications of malfunctions.
- The device only supports USB devices used to play music files.
- USB images and videos are not supported.

(Continued)

(Continued)

- Do not use the USB I/F to charge batteries or USB accessories that generate heat. Such acts may lead to worsened performance or damage to the device.
- The device may not recognize the USB device if separately purchased USB hubs and extension cables are being used. Connect the USB directly with the multimedia terminal of the vehicle.
- When using mass storage USB devices with separate logical drives, only files saved to the root drive can be played.
- Files may not properly operate if application programs are installed to the USBs.
- The device may not operate normally if MP3 Players, cellular phones, digital cameras, or other electronic devices (USB devices not recognized as portable disk drives) are connected with the device.

(Continued)

(Continued)

- Charging through the USB may not work for some mobile devices.
- The device may not support normal operation when using a USB memory type besides (Metal Cover Type) USB Memory.
- The device may not support normal operation when using formats such as HDD Type, CF, or SD Memory.
- The device will not support files locked by DRM (Digital Rights Management.)
- USB memory sticks used by connecting an Adaptor (SD Type or CF Type) may not be properly recognized.
- The device may not operate properly when using USB HDDs or USBs subject to connection failures caused by vehicle vibrations. (e.g. i-stick type)

(Continued)

(Continued)

- Avoid use of USB memory products that can also be used as key chains or mobile phone accessories. Use of such products may cause damage to the USB jack.
- Connecting an MP3 device or phone through various channels, such as AUX/BT or Audio/USB mode may result in pop noises or abnormal operation.



i Information

- Using the iPod® Device

- iPod® is a registered trademark of Apple Inc.
- In order to use the iPod® while operating the buttons, you must use a dedicated iPod® cable. (the cable that is supplied when purchasing iPod®/ iPhone® products)
- If the iPod® is connected to the vehicle while it is playing, a high pitch sound could occur for approximately 1-2 seconds immediately after connecting. If possible, connect the iPod® to the vehicle with the iPod® stopped/paused.
- During ACC ON state, connecting the iPod® through the iPod® cable will charge the iPod® through the car audio system.
- When connecting with the iPod® cable, make sure to fully insert the jack to prevent communication interference.

(Continued)

(Continued)

- When the EQ features of an external device, such as the iPod®, and the audio system are both active, EQ effects could overlap and cause sound deterioration and distortion. Whenever possible, turn off the EQ feature within the external device upon use by connecting with the audio system.
- Noise may occur when an iPod® or AUX device is connected. When such devices are not being used, disconnect the device for storage.
- When the iPod® or AUX device power is connected to the power jack, playing the external device may result in noise. In such cases, disconnect the power connection before use.
- Skipping or improper operation may occur depending on the characteristics of your iPod®/iPhone® device.
- If your iPhone is connected to both the *Bluetooth*® Wireless Technology and USB, the sound may not be properly played. In your iPhone®, select the Dock connector or *Bluetooth*® Wireless Technology to change the sound output (source).

(Continued)

(Continued)

- iPod® mode cannot be operated when the iPod® cannot be recognized due to the playing of versions that do not support communication protocols, cases of iPod® abnormalities and defects.
- For fifth generation iPod® Nano devices, the iPod® may not be recognized when the battery level is low. Please charge the iPod® for use.
- Search/play orders shown within the iPod® device may differ with the orders shown within the audio system.
- If the iPod® malfunctions due to an iPod® device defect, reset the iPod® and try again. (To learn more, refer to your iPod® manual)
- Some iPod®s may not sync with the System depending on its version. If the Media is removed before the system may not properly restore the previously operated mode. (iPad charging is not supported.)
- Beside support 1M cable when purchasing iPod®/iPhone® products, Long Cable cannot be recognized.

i Information

- Using the *Bluetooth*® Wireless Technology Audio Mode

- *Bluetooth*® Wireless Technology Audio Mode can be used only when a *Bluetooth*® Wireless Technology phone has been connected.
- *Bluetooth*® Wireless Technology Audio Mode will not be available when connecting mobile phones that do not support this feature.
- While *Bluetooth*® Wireless Technology Audio is playing, if the *Bluetooth*® Wireless Technology phone is connected, then the music will also stop.
- Moving the Track up/down while playing *Bluetooth*® Wireless Technology audio mode may result in pop noises in some mobile phones.
- *Bluetooth*® Wireless Technology streaming audio may not be supported in some mobile phones.

(Continued)

(Continued)

- When returning to *Bluetooth*[®] Wireless Technology Audio mode after ending a call, the mode may not automatically restart in some mobile phones.
- Receiving an incoming call or making an outgoing call while playing *Bluetooth*[®] Wireless Technology Audio may result in audio interference.

i Information

- Using the *Bluetooth*[®] Wireless Technology Cellular Phone

- *Bluetooth*[®] Wireless Technology Handsfree refers to a device which allows the user to conveniently make phone calls with *Bluetooth*[®] Wireless Technology mobile phones through the audio system.
- *Bluetooth*[®] Wireless Technology allows devices to be connected in a short distance, including hands-free devices, stereo headsets, wireless remote controllers, etc. For more information, visit the *Bluetooth*[®] Wireless Technology website at www.Bluetooth.com. Before using *Bluetooth*[®] Wireless Technology audio features.
- The *Bluetooth*[®] word mark and logos are registered trademarks owned by *Bluetooth*[®] SIG, Inc. and any use of such marks by Hyundai is under license. Other trademarks and trade names are those of their respective owners. A *Bluetooth*[®] enabled cell phone is required to use *Bluetooth*[®] Wireless Technology.

(Continued)

(Continued)

- *Bluetooth*[®] Wireless Technology features supported within the vehicle are as follows. Some features may not be supported depending on your *Bluetooth*[®] Wireless Technology device.
 - Answering and placing *Bluetooth*[®] Wireless Technology Handsfree calls
 - Menu operation during call (Switch to Private, Switch to call waiting, Outgoing volume)
 - Download Call History
 - Download Mobile Phone book
 - Phone book/Call History Auto Download
 - *Bluetooth*[®] Wireless Technology device auto connection
 - *Bluetooth*[®] Wireless Technology Audio
- Before using *Bluetooth*[®] Wireless Technology related features of the audio system, refer your phone's User's Manual for phone-side *Bluetooth*[®] Wireless Technology operations.

(Continued)

(Continued)

- The phone must be paired to the audio system to use *Bluetooth*[®] Wireless Technology related features.
- Pairing and connecting a *Bluetooth*[®] Wireless Technology enabled mobile phone will work only when the *Bluetooth*[®] Wireless Technology option within your mobile phone has been turned on. (Methods of turning on the *Bluetooth*[®] Wireless Technology enabled feature may differ depending on the mobile phone.)
- Do not use a cellular phone or perform *Bluetooth*[®] Wireless Technology settings (e.g. pairing a phone) while driving.

(Continued)

(Continued)

- Even if the phone supports *Bluetooth*[®] Wireless Technology, the phone will not be found during device searches if the phone has been set to hidden state or the *Bluetooth*[®] Wireless Technology power is turned off. Disable the hidden state or turn on the *Bluetooth*[®] Wireless Technology power prior to searching/connecting with the car audio system.
- You will not be able to use the hands-free feature when your phone (in the car) is outside of the cellular service area (e.g. in a tunnel, in a underground, in a mountainous area, etc.).
- If the cellular phone signal is poor or the vehicles interior noise is too loud, it may be difficult to hear the other person's voice during a call.
- Do not place the phone near or inside metallic objects, otherwise communications with *Bluetooth*[®] Wireless Technology system or cellular service stations can be disturbed.

(Continued)

(Continued)

- Placing the audio system within an electromagnetic environment may result in noise interference.
- Some cellular phones or other devices may cause interference noise or malfunction to audio system. In this case, store the device in a different location may resolve the condition.
- While a phone is connected through *Bluetooth*[®] Wireless Technology your phone may discharge quicker than usual for additional *Bluetooth*[®] Wireless Technology-related operations.
- If Priority is set upon vehicle ignition (IGN/ACC ON), the *Bluetooth*[®] Wireless Technology phone will be automatically connected. Even if you are outside, the *Bluetooth*[®] Wireless Technology phone will be automatically connected once you are in the vicinity of the vehicle. If you do not want to automatically connect your *Bluetooth*[®] Wireless Technology phone, try the following.

(Continued)

(Continued)

- 1) Turn off the *Bluetooth*[®] Wireless Technology feature in your mobile phone.
- 2) Turn off the *Bluetooth*[®] Wireless Technology feature in your car audio system.
 - To turn off the *Bluetooth*[®] Wireless Technology feature in your car audio system, go to [SETUP] > [Phone] and [turn off] the *Bluetooth*[®] Wireless Technology feature.
- *Bluetooth*[®] Wireless Technology connection may become intermittently disconnected in some mobile phones. Follow these steps to try again.
 - 1) Turn the *Bluetooth*[®] Wireless Technology function within the mobile phone off/on and try again.
 - 2) Turn the mobile phone power Off/On and try again.
 - 3) Completely remove the mobile phone battery, reboot, and then again.

(Continued)

(Continued)

- 4) Reboot the audio system and try again.
 - 5) Delete all paired devices, pair and try again.
- It is possible to pair up to five *Bluetooth*[®] Wireless Technology devices to the car system.
 - Phone contact names should be saved in English or they may not be displayed correctly.
 - The Handsfree call volume and quality may differ depending on the mobile phone.
 - Only one *Bluetooth*[®] Wireless Technology device can be connected at a time.
 - In some mobile phones, starting the ignition while talking through *Bluetooth*[®] Wireless Technology enabled handsfree call will result in the call becoming disconnected. (Switch the call back to your mobile phone when starting the ignition.)
 - If the mobile phone is not paired or connected, it is not possible to enter Phone mode. Once a phone is paired or connected, the guidance screen will be displayed.

NOTICE

- *Bluetooth*[®] Wireless Technology Handsfree is a feature that enables drivers to practice safe driving. Connecting the car audio system with a *Bluetooth*[®] Wireless Technology phone allows the user to conveniently make calls, receive calls, and manage the phone book. Before using the *Bluetooth*[®] Wireless Technology, carefully read the contents of this user's manual.
- Excessive use or operations while driving may lead to negligent driving practices and be the cause of accidents.
- Do not operate the device excessively while driving.
- Viewing the screen for prolonged periods of time is dangerous and may lead to accidents.
- When driving, view the screen only for short periods of time.

Radio Mode (Type B-1, Type B-2, Type B-3, Type B-4)

Radio Mode Display Controls

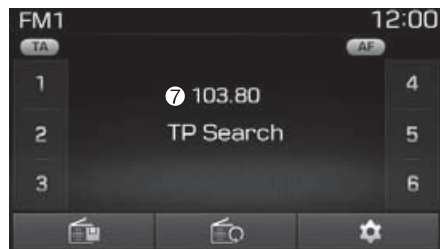
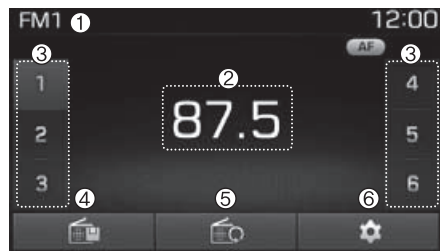

(1) Mode Display
Displays currently operating mode.

(2) Frequency
Displays the current frequency.

(3) Preset
Displays current preset number [1] ~ [6].

(4) Preset Display
Displays saved presets.

(5) Auto store
Automatically saves frequencies with superior reception to Preset buttons.

(6) RDS Menu
Displays the RDS Menu.

(7) RDS Info
Displays RDS broadcast information.

With the Radio Mode Button

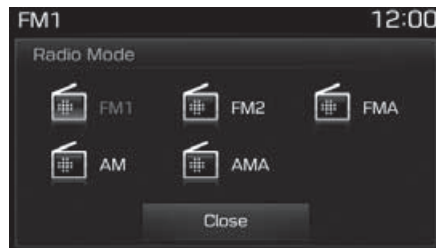

Pressing the **[RADIO]** button will change the operating mode in order of FM1 → FM2 → FMA → AM → AMA.

If [Pop-up Mode] is turned on within **[SETUP]** ► [Display], then pressing the **[RADIO]** button will display the Radio Pop-up Mode screen.

Turn the **TUNE** knob to move the focus. Press the knob to select.

SEEK

Press the **[SEEK TRACK]** button to play the previous/next frequency.

TUNE

Turn the **TUNE** knob to select the desired frequency.

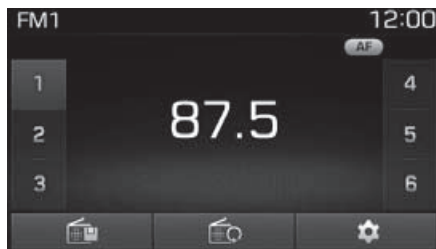

Selecting/Saving Presets

Press the [1] ~ [6] buttons to play the desired preset.

Press the [Preset] button to display the broadcast information for the frequency saved to each button.

While listening to a frequency you want to save as a preset, press and hold one of the [1] ~ [6] preset buttons to save the current frequency to the selected preset.

Auto Store

Press the [Auto store] button to automatically save receivable frequencies to Preset buttons.

While Auto Store is operating, pressing the [Auto store] button again will cancel Auto Store and restore the previous frequency.



RDS Menu

Press the [RDS Menu] button to set the AF (Alternative Frequency), Region and News features.

The RDS Menu is not supported within AM or AMA mode.

Scan

Press the [TA/SCAN] button :
Previews each broadcast for 5 seconds each

Once scan is complete, the previous frequency will be restored.

While Scan is operating, pressing and holding the [TA/SCAN] button will cancel the scan operation.

TA (Traffic Announcement)

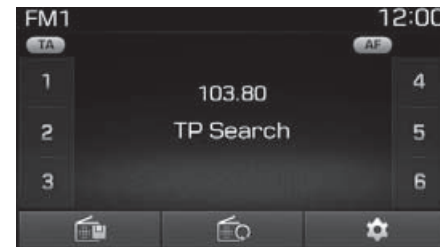

Press the [TA/SCAN] button to turn the TA (Traffic Announcement) feature On/Off.

Radio Mode (Type B-5, Type B-6)

Radio Mode Display Controls

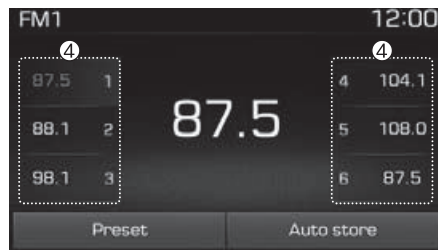
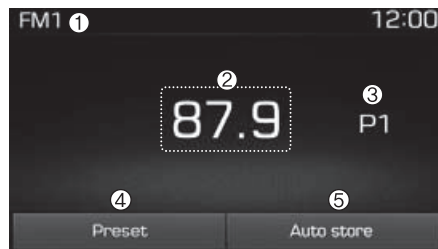

(1) Mode Display
Displays currently operating mode.

(2) Frequency
Displays the current frequency.

(3) Preset
Displays current preset number [1] ~ [6].

(4) Preset Display
Displays preset buttons.

(5) Auto store
Automatically saves frequencies with superior reception to Preset buttons.

With the Radio Mode Button

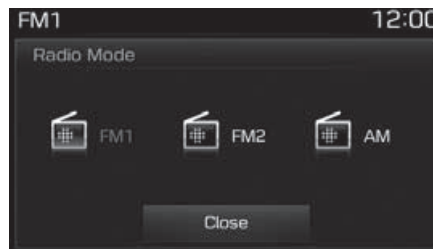

Pressing the **[RADIO]** button will change the operating mode in order of FM1 → FM2 → AM.

If [Mode Pop-up] is turned on within **[SETUP] ► [Display]**, then pressing the **[RADIO]** button will display the Radio Mode Pop-up screen.

Turn the **TUNE** knob to move the focus. Press the knob to select.

SEEK

Press the **[SEEK TRACK]** button to play the previous/next frequency.

TUNE

Turn the **TUNE** knob to select the desired frequency.



Selecting /Saving Presets

Press the **[Preset]** button to display the broadcast information for the frequency saved to each button.

Press the [1] ~ [6] buttons to play the desired preset.

While listening to a frequency you want to save as a preset, press and hold one of the [1] ~ [6] preset buttons to save the current frequency to the selected preset.

Auto Store

Press the [Auto store] button to automatically save receivable frequencies to Preset buttons.

Scan

Press the [**SCAN**] button to preview frequencies with superior reception for 5 seconds each.

Press and hold the [**SCAN**] button to preview presets for 5 seconds each.

Once scan is complete, the previous frequency will be restored.

While Scan is operating, pressing the [**SCAN**] button will cancel the scan operation.

Media Mode

Media Mode Screen

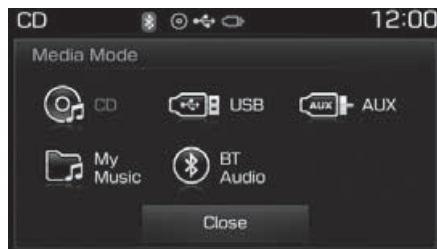

Pressing the [**MEDIA**] button will change the operating mode in order of CD → USB(iPod®) → AUX → My Music → BT Audio.

If [Pop-up Mode] / [Mode Pop-up] is turned on within [**SETUP**] ► [Display], then pressing the [**MEDIA**] button will display the Media Pop-up Mode screen.

Turn the **TUNE** knob to move the focus. Press the knob to select.

The media mode pop up screen can be displayed only when there are two or more media modes turned on.

Mode Display on the Status Bar



When a *Bluetooth®* Wireless Technology, iPod®, USB or AUX device is connected or a CD is inserted, the corresponding mode icon will be displayed.

Icon	Title
	<i>Bluetooth®</i> Wireless Technology
	CD
	iPod®
	USB
	AUX

MENU : Audio CD

Audio CD Mode Display Controls

■ Type B-1, Type B-2, Type B-3, Type B-4

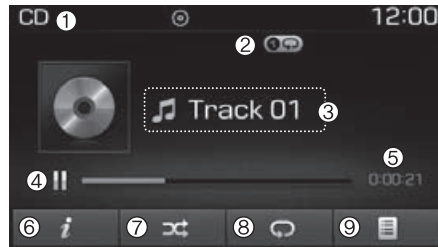

■ Type B-5, Type B-6



(1) Mode

Displays currently operating mode.

(2) Operation State

From Repeat/Random(Shuffle)/Scan, displays the currently operating function.

(3) Track Info

Displays information about the current track.

(4) Play/Pause

Changes the play/pause state.

(5) Play Time

Displays the current play time.

(6) Info

Shows detailed information about the current track.

(7) Random(Shuffle)

Turns the Random(Shuffle) feature on/off.

(8) Repeat

Turns the Repeat feature on/off.

(9) List

Moves to the list screen.

Turn the **TUNE** knob left/right to search for tracks. Once the desired track is displayed, press the knob to select and play.

With the Audio CD Mode

Playing/Pausing CD Tracks

Once an audio CD is inserted, the mode will automatically start and begin playing.

While playing, press the [II] button to pause and press [▶] button to play.

Only genuine audio CDs are supported. Other discs may result in recognition failure (e.g. copy CD-R, CDs with labels)

The artist and title information are displayed on the screen if track information is included within the audio CD.

Changing Tracks

Press the [SEEK TRACK] button to move to the previous or next track.

Pressing the [SEEK TRACK √] button after the track has been playing for 2 seconds will start the current track from the beginning.

Pressing the [SEEK TRACK √] button before the track has been playing for 1 second will start the previous track.

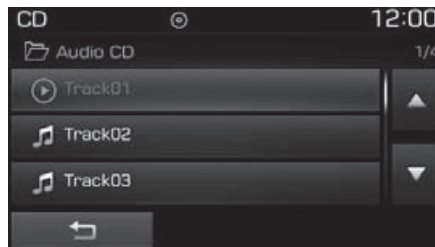

Selecting from the List

Turn the **TUNE** knob left/right to search for the desired track.

Once you find the desired track, press the **TUNE** knob to start playing.

Rewinding / Fast-forwarding Tracks

While playing, press and hold the [SEEK TRACK] button to rewind or fast-forward the current track.

Scan (With RDS)

Press and hold the [TA/SCAN] button to play the file 10 seconds of each file.

Press and hold the [TA/SCAN] button again to turn off.

Scan (Without RDS)

Press the [SCAN] button to play the first 10 seconds of each file.

Press and hold the [SCAN] button again to turn off.

MENU : MP3 CD

MP3 CD Mode Display Controls

■ Type B-1, Type B-2, Type B-3, Type B-4

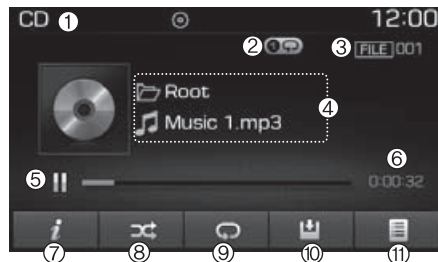

■ Type B-5, Type B-6

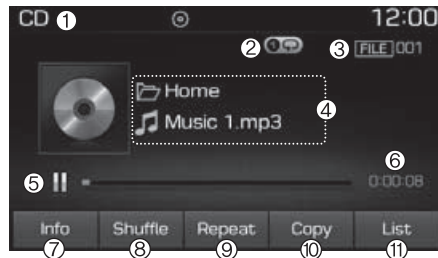

(1) Mode

Displays currently operating mode.

(2) Operation State

From Repeat/Random(Shuffle)/Scan, displays the currently operating function.

(3) File Index

Displays the current file number.

(4) File Info

Displays information about the current file.

(5) Play/Pause

Changes the play/pause state.

(6) Play Time

Displays the current play time.

(7) Info

Shows detailed information about the current file.

When the 'Folder File' option is set as the default display within Display setup, the album/artist/file information are displayed as detailed file information.

When the 'Album Artist Song' option is set as the default display, the folder name/file name are displayed as detailed file information.

The title, artist and album info are displayed only when such information are recorded within the MP3 file ID3 tag.

(8) Random(Shuffle)

Turns the Random(Shuffle) feature on/off.

Each time the button is pressed, the feature changes in order of Random (Shuffle) Folder → Random (Shuffle) All → Off.

- Random(Shuffle) Folder : Plays all files within the current folder in Random (Shuffle) order.
- Random(Shuffle) All : Plays all files in Random(Shuffle) order.

(9) Repeat

Turns the Repeat feature on/off.

Each time the button is pressed, the feature changes in order of Repeat → Repeat Folder → Off.

- Repeat : Repeats the current file.
- Repeat Folder : Repeats all files within the current Folder.

(10) Copy

Copies the current file into My Music.

Selecting another feature during copying will display a pop-up asking whether you wish to cancel copying. To cancel, select “Yes”.

(11) List

Moves to the list screen.

Turn the **TUNE** knob left/right to search for files. Once the desired file is displayed, press the knob to select and play.

With the MP3 CD Mode

Playing/Pausing MP3 Files

Once an MP3 disc is inserted the mode will automatically start and begin playing.

While playing, press the [II] button to pause and press [▶] button to play.

If there are numerous files and folders within the disc, reading time could take more than 10 seconds and the list may not be displayed or song searches may not operate. Once loading is complete, try again.

Changing Files

Press the [**SEEK TRACK**] button to move to the previous or next file.

Pressing the [**SEEK TRACK** √] button after the file has been playing for 2 seconds will start the current file from the beginning.

Pressing the [**SEEK TRACK** √] button before the file has been playing for 1 second will start the previous file.

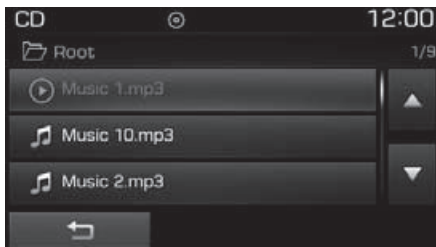

Selecting from the List

Turn the **TUNE** knob left/right to search for the desired file.

Once you find the desired file, press the **TUNE** knob to start playing.

Rewinding / Fast-forwarding Files

While playing, press and hold the **[SEEK TRACK]** button to rewind or fast-forward the current file.

Scan (With RDS)

Press and hold the **[TA/SCAN]** button to play the file 10 seconds of each file.

Press and hold the **[TA/SCAN]** button again to turn off.

Scan (Without RDS)

Press the **[SCAN]** button to play the first 10 seconds of each file.

Press the **[SCAN]** button again to turn off.

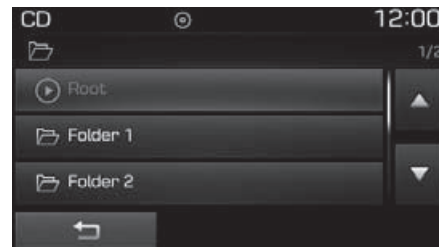

Searching Folders

Press the **[FOLDER]** button to select and search folders.

Once the desired folder is displayed, press the **TUNE** knob to select.

The first file within the selected folder will begin playing.

MENU : USB

USB Mode Display Controls

■ Type B-1, Type B-2, Type B-3, Type B-4

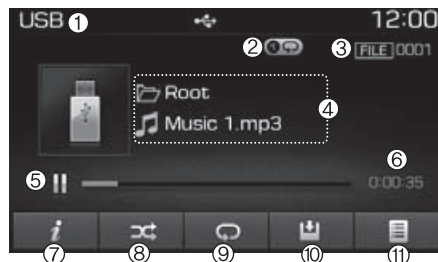

■ Type B-5, Type B-6

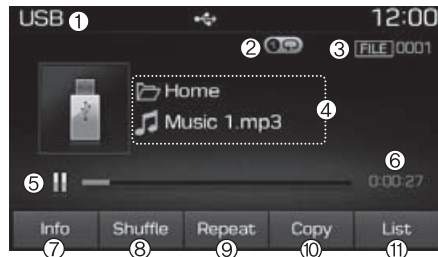

(1) Mode

Displays currently operating mode.

(2) Operation State

From Repeat/Random(Shuffle)/Scan, displays the currently operating function.

(3) File Index

Displays the current file number.

(4) File Info

Displays information about the current file.

(5) Play/Pause

Changes the play/pause state.

(6) Play Time

Displays the current play time.

(7) Info

Displays detailed information for the current file.

When the 'Folder File' option is set as the default display within Display setup, the album/artist/file information are displayed as detailed file information.

When the 'Album Artist Song' option is set as the default display, the folder name/file name are displayed as detailed file information.

The title, artist and album info are displayed only when such information are recorded within the MP3 file ID3 tag.

(8) Random(Shuffle)

Turns the Random(Shuffle) feature on/off.

Each time the button is pressed, the feature changes in order of Random(Shuffle) Folder → Random(Shuffle) All → Off.

- Random(Shuffle) Folder : Plays the files in the current folder in random(Shuffle) order.
- Random(Shuffle) All : Plays all files in random(Shuffle) order.

(9) Repeat

Turns the Repeat feature on/off.

Each time the button is pressed, the feature changes in order of Repeat → Repeat Folder → Off.

- Repeat : Repeats the current file.
- Repeat Folder : Repeats all files within the current folder.

(10) Copy

Copies the current file into My Music.

Selecting another feature during copying will display a pop-up asking whether you wish to cancel copying. To cancel, select “Yes”.

(11) List

Moves to the list screen.

Turn the **TUNE** knob left/right to search for files. Once the desired file is displayed, press the knob to select and play.

With the USB Mode

Playing/Pausing USB Files

Once a USB is connected, the mode will automatically start and begin playing a USB file.

While playing, press the [II] button to pause and press [▶] button to play.

Loading may require additional time if there are many files and folders within the USB and result in faulty list display or file searching. Normal operations will resume once loading is complete.

The device may not support normal operation when using a USB memory type besides (Metal Cover Type) USB Memory.

Changing Files

Press the **[SEEK TRACK]** button to move to the previous or next file.

Pressing the **[SEEK TRACK ∇]** button after the file has been playing for 2 seconds will start the current file from the beginning.

Pressing the **[SEEK TRACK ∇]** button before the file has been playing for 1 second will start the previous file.

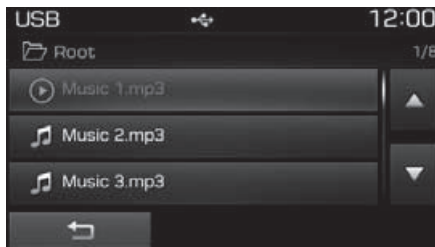

Selecting from the List

Turn the **TUNE** knob left/right to search for the desired file.

Once you find the desired file, press the **TUNE** knob to start playing.

Rewinding / Fast-forwarding Files

While playing, press and hold the **[SEEK TRACK]** button to rewind or fast-forward the current file.

Scan (With RDS)

Press and hold the **[TA/SCAN]** button to play the file 10 seconds of each file.

Press and hold the **[TA/SCAN]** button again to turn off.

Scan (Without RDS)

Press the **[SCAN]** button to play the first 10 seconds of each file.

Press the **[SCAN]** button again to turn off.

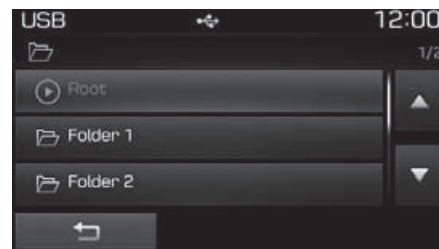

Searching Folders

Press the **[FOLDER]** button to select and search folders.

Once the desired folder is displayed, press the **TUNE** knob to select.

The first file within the selected folder will begin playing.

MENU : iPod®

iPod® Mode Display Controls

■ Type B-1, Type B-2, Type B-3, Type B-4

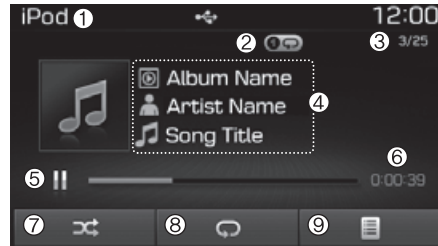

■ Type B-5, Type B-6

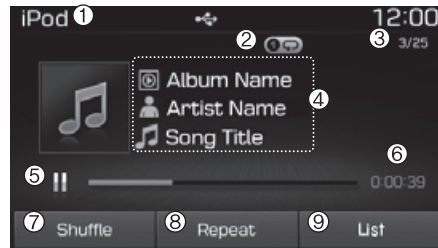

(1) Mode

Displays currently operating mode.

(2) Operation State

From Repeat/Random(Shuffle), displays the currently operating function.

(3) Song Index

Displays the current song/total number of songs.

(4) Song Info

Displays information about the current song.

(5) Play/Pause

Changes the play/pause state.

(6) Play Time

Displays the current play time.

(7) Random(Shuffle)

Turns the Random(Shuffle) feature on/off.

- Random(Shuffle) All : Plays all songs in Random(Shuffle) order.

(8) Repeat

Turns the Repeat feature on/off.

- Repeat : Repeats the current song

(9) List

Moves to the list screen.

Turn the **TUNE** knob left/right to search for the desired category.

Once you find the desired category, press the **TUNE** knob to select and play.

With the iPod® Mode

Playing/Pausing iPod® Songs

Once an iPod® is connected, the mode will automatically start and begin playing an iPod® song.

While playing, press the [||] button to pause and press [▶] button to play.

iPod®s with unsupported communication protocols may not properly operate in the audio system.

Changing Songs

Press the [SEEK TRACK] button to move to the previous or next song.

Pressing the [SEEK TRACK ∇] button after the song has been playing for 2 seconds will start the current song from the beginning.

Pressing the [SEEK TRACK ∇] button before the song has been playing for 1 second will start the previous song.

Slight time differences may exist depending your iPod® product.

Rewinding / Fast-forwarding Songs

While playing, press and hold the [SEEK TRACK] button to rewind or fast-forward the current song.

■ Type B-1, Type B-2, Type B-3, Type B-4

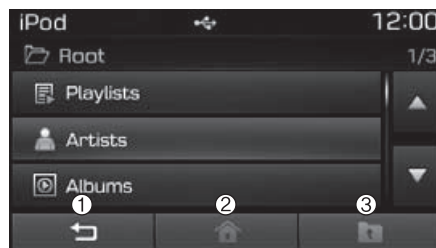

■ Type B-5, Type B-6

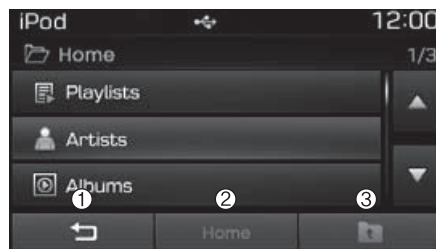

Searching Categories

Turn the **TUNE** knob left/right to search for the desired category.

Once you find the desired category, press the **TUNE** knob to select and play.

There are eight categories that can be searched, including Playlists, Artists, Albums, Genres, Songs, Composers, Audiobooks and Podcasts.

Category Menu

- (1) Displays the play screen.
- (2) Moves to the iPod® root category screen.
- (3) Moves to the previous category.

If the search mode is accessed while playing a song, the most recently searched category is displayed.

Search steps upon initial connection may differ depending on the type of iPod® device.

MENU : AUX

AUX Mode Display Controls

■ Type B-1, Type B-2, Type B-3, Type B-4

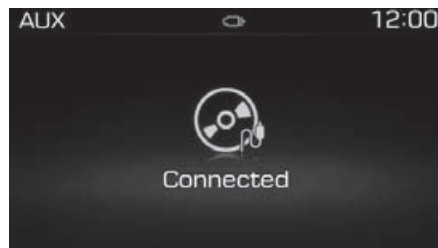

■ Type B-5, Type B-6

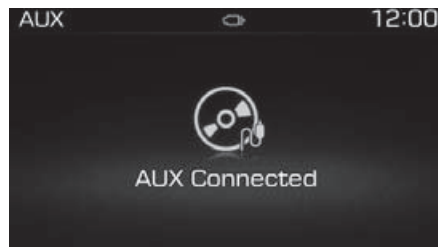

Press the **[MEDIA]** button ► Select **[AUX]**

An external device can be connected to play music.

Connecting an External Device

External audio players (Camcorders, Car VCR, etc.) can be played through a dedicated cable.

If an external device connector is connected with the AUX terminal, then AUX mode will automatically operate. Once the connector is disconnected, the previous mode will be restored.

AUX mode can be used only when an external audio player (Camcorder, Car VCR, etc.) has been connected.

The AUX volume can be controlled separately from other audio modes.

Connecting a connector jack to the AUX terminal without an external device will convert the system to AUX mode, but only output noise. When an external device is not being used, also remove the connector jack.

When the external device power is connected to the power jack, playing the external device may output noise. In such cases, disconnect the power connection before use.

Fully insert the AUX cable to the AUX jack upon use.

MENU : My Music Mode

My Music Mode Display Controls

■ Type B-1, Type B-2, Type B-3, Type B-4



■ Type B-5, Type B-6

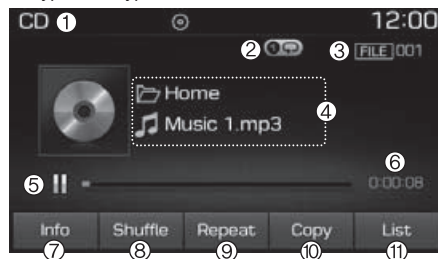

(1) Mode

Displays currently operating mode.

(2) Operation State

From Repeat/Random(Shuffle)/Scan, displays the currently operating function.

(3) File Index

Displays the current file/total number of files.

(4) File Info

Displays information about the current file.

(5) Play/Pause

Changes the play/pause state.

(6) Play Time

Displays the current play time.

(7) Info

Displays detailed information for the current file.

The title, artist and album info are displayed only when such information is recorded within the MP3 file ID3 tag.

(8) Random(Shuffle)

Turns the Random(Shuffle) feature on/off.

(9) Repeat

Turns the Repeat feature on/off.

(10) Delete

Deletes the current file.

(11) List

Moves to the list screen.

Turn the **TUNE** knob left/right to search for files. Once the desired file is displayed, press the knob to select and play.

With the My Music Mode

Playing/Pausing My Music Files

While playing, press the [II] button to pause and press [▶] button to play.

If there are no files saved within My Music, the [My Music] button will be disabled.

Changing Files

Press the [SEEK TRACK] button to move to the previous or next file.

Pressing the [SEEK TRACK V] button 2 seconds after the file has been playing for 2 seconds will start the current file from the beginning.

Pressing the [SEEK TRACK V] button before the file has been playing for 1 second will start the previous file.

■ Type B-1, Type B-2, Type B-3, Type B-4

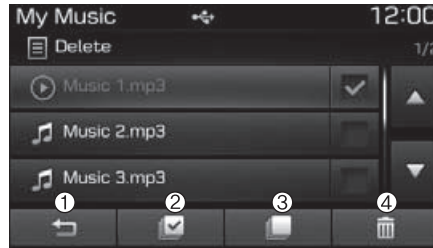

■ Type B-5, Type B-6

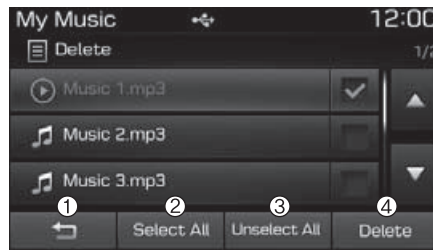

Selecting from the List

Turn the **TUNE** knob left/right to search for the desired file.

Once you find the desired file, press the **TUNE** knob to start playing.

From the List screen, it is possible to delete files you previously saved into My Music.

List Menu

- (1) Moves to the previous screen.
- (2) Selects all files.
- (3) Deselects all selected files.
- (4) Deletes selected files.

After selecting the files you want to delete, press the [Delete] button to delete the selected files.

If there is memory available, up to 6,000 files can be saved. Identical files cannot be copied more than 1,000 times.

To check memory information, go to [SETUP] ▶ [System] ▶ [Memory Information]

Rewinding / Fast-forwarding Files

While playing, press and hold the [SEEK TRACK] button to rewind or fast-forward the current file.

Scan (With RDS)

Press and hold the **[TA/SCAN]** button to play the file 10 seconds of each file.

Press and hold the **[TA/SCAN]** button again to turn off.

Scan (Without RDS)

Press the **[SCAN]** button to play the first 10 seconds of each file.

Press the **[SCAN]** button again to turn off.

MENU : *Bluetooth*[®] Wireless Technology Audio

Using *Bluetooth*[®] Wireless Technology Audio Mode

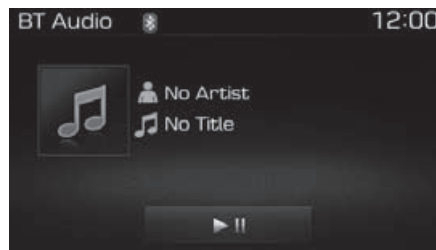

Playing/Pausing *Bluetooth*[®] Wireless Technology Audio

Once a *Bluetooth*[®] Wireless Technology device is connected, the mode will automatically start.

While playing, press the **[▶||]** button to pause and press **[▶||]** button to play.

The play/pause feature may operate differently depending on the mobile phone.

Changing Files

Press the **[SEEK TRACK]** button to move to the previous or next file.

Setting Connection

If a *Bluetooth*[®] Wireless Technology device has not been connected, press the **[SETUP]** button ▶ **[Phone]** button to display the *Bluetooth*[®] Wireless Technology connection screen.

It is possible to use the pair phone, connect/disconnect and delete features from your *Bluetooth*[®] Wireless Technology phone.

If music is not yet playing from your mobile device after converting to *Bluetooth*[®] Wireless Technology Audio mode, pressing the play button once may start playing the mode. Check to see that music is playing from the *Bluetooth*[®] Wireless Technology device after converting to *Bluetooth*[®] Wireless Technology Audio Mode.

Phone Mode

Making a call using the Steering wheel controls

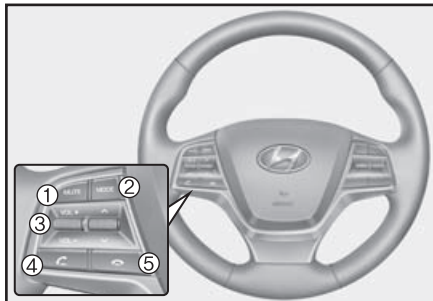

* The actual features in the vehicle may differ from the illustration.

- (1) Mutes audio volume.
- (2) Press the button to change audio source.

(With RDS)

FM1 → FM2 → FMA → AM →
AMA → CD → USB(iPod®) → AUX
→ My Music → BT Audio.

(Without RDS)

FM1 → FM2 → AM → CD →
USB(iPod®) → AUX → My Music
→ BT Audio.

- (3) Used to control volume.
- (4) When pressed shortly
 - When pressed in the phone screen, displays call history screen
 - When pressed in the dial screen, makes a call
 - When pressed in the incoming call screen, answers the call
 - When pressed during call waiting, switches to waiting call (Call Waiting)

When pressed and held

- When pressed in the *Bluetooth*® Wireless Technology Handsfree wait mode, redials the last call
- When pressed during a *Bluetooth*® Wireless Technology Handsfree call, switches call back to mobile phone (Private)
- When pressed while calling on the mobile phone, switches call back to *Bluetooth*® Wireless Technology Handsfree (Operates only when *Bluetooth*® Wireless Technology Handsfree is connected)

- (5) Ends phone call

Bluetooth® Wireless Technology (Type B-1, Type B-2, Type B-3, Type B-4)

When No Devices have been Paired



- ① Press the **[PHONE]** button or the **[CALL]** button on the steering wheel controls. The following screen is displayed.
- ② Press the **[OK]** button to enter the Pair Phone screen.



- Device : Name of device as shown when searching from your *Bluetooth*® Wireless Technology device
 - Passkey : Passkey used to pair the device
- ③ From your *Bluetooth*® Wireless Technology device (i.e. Mobile Phone), search and select your car audio system.

* SSP : Secure Simple Pairing

Non SSP supported device :

- ④ After a few moments, a screen is displayed where the passkey is entered.
Enter the passkey “0000” to pair your *Bluetooth*® Wireless Technology device with the car audio system.



SSP supported device :

- ④ After a few moments, a screen is displayed 6 digits passkey.
Check the passkey on your *Bluetooth*® Wireless Technology device and confirm.
- ⑤ Once pairing is complete, the following screen is displayed.

Some phones (i.e., iPhone®, Android and Blackberry phones) may offer an option to allow acceptance of all future *Bluetooth*® connection requests by default.” and “Visit <http://www.Hyundai.com/#/bluetooth> for additional information on pairing your *Bluetooth*®-enabled mobile phone, and to view a phone compatibility list.

i Information



If *Bluetooth*® Wireless Technology devices are paired but none are currently connected, pressing the [PHONE] button or the [CALL] button on the steering wheel controls displays the following screen. Press the [Pair] button to pair a new device or press the [Connect] to connect a previously paired device.

Pairing through [PHONE] Setup

Press the [SETUP] button ► Select [Phone]

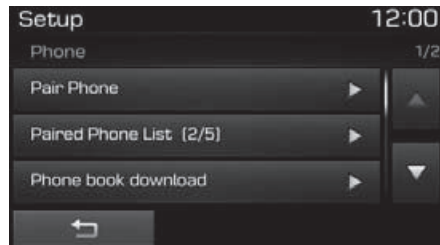

Pair Phone

The following steps are the same as those described in the section “When No Devices have been Paired” on the previous page.

i Information

- The waiting period during phone pairing will last for one minute. The pairing process will fail if the device is not paired within the given time. If the pairing process fails, you must start the process from the beginning.
- Generally, most *Bluetooth*[®] Wireless Technology devices will automatically connect once pairing is complete. However, some devices may require a separate verification process to connect. Check to see whether *Bluetooth*[®] Wireless Technology has been properly connected within your mobile phone.
- List of paired *Bluetooth*[®] Wireless Technology devices can be viewed at [SETUP] ► [Phone] ► [Paired Phone List].

Paired Phone List

Press the [SETUP] button ► Select [Phone] ► Select [Paired Phone List]

- Connected Phone : Device that is currently connected.
- Paired Phone : Device that is paired but not connected.

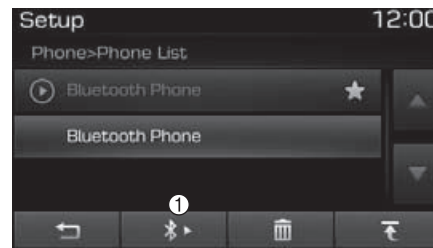

Connecting a Device

From the paired phone list, select the device you want to connect and press the [Connect](1) button.

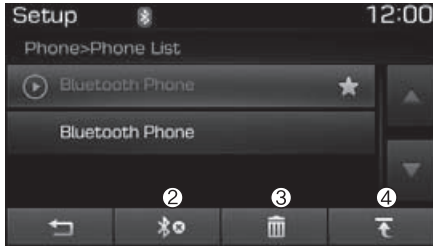

Disconnecting a Device

From the paired phone list, select the currently connected device and press the [Disconnect](2) button.

Deleting a Device

From the paired phone list, select the device you want to delete and press the [Delete](3) button.

i Information

- When deleting the currently connected device, the device will automatically be disconnected to proceed with the deleting process.
- If a paired *Bluetooth*[®] Wireless Technology device is deleted, the device's call history and phone book data will also be deleted.
- To re-use a deleted device, you must pair the device again.

Changing Priority

It is possible to pair up to five *Bluetooth*[®] Wireless Technology devices with the car audio system. The "Change Priority" feature is used to set the connection priority of paired phones. However, the most recently connected phone will always be set as the highest priority.

From the paired phone list, select the phone you want to switch to the highest priority, then press the [Change priority](4) button. The selected device will be changed to the highest priority.

When a device is currently connected, even if you change the priority to a different device, the currently connected phone will always be set as the highest priority.

Phone Menu Screen

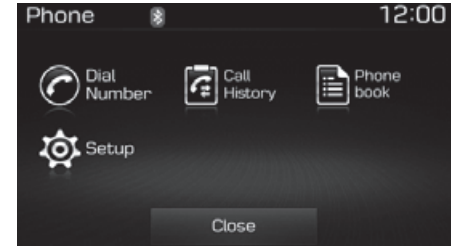

Phone Menus

With a *Bluetooth*[®] Wireless Technology device connected, press the [PHONE] button to display the Phone menu screen.

- Dial Number : Displays the dial screen where numbers can be dialed to make calls.
- Call History : Displays the call history list screen.
- Phone book : Displays the Phone book list screen.
- Setup : Displays Phone related settings.

i Information

- If you press the [Call History] button but there is no call history data, a prompt is displayed which asks whether to download call history data.
- If you press the [Phone book] button but there is no phone book data, a prompt is displayed which asks whether to download phone book data.
- This feature may not be supported in some mobile phones. For more information on download support, refer to your mobile phone user's manual.

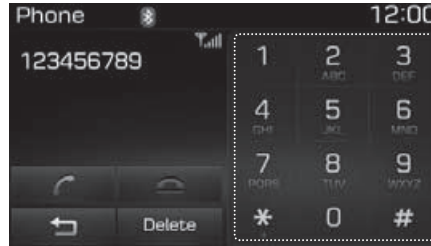

Calling by Dialing a Number

- Dial Pad : Used to enter phone number.
- Call : If a number has been entered, calls the number. If no number has been entered, switches to call history screen.
- End : Deletes the entered phone number.
- Delete : Deletes entered numbers one digit at a time.

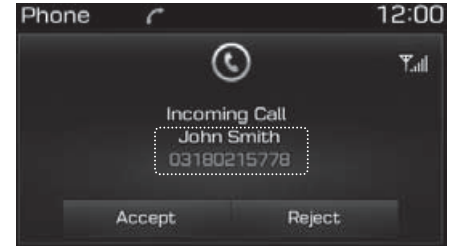

Answering a Call

Answering a call with a *Bluetooth®* Wireless Technology device connected will display the following screen.

- Caller : Displays the other party's name when the incoming caller is saved within your phone book.
- Incoming Number : Displays the incoming number.
- Accept : Accepts the incoming call.
- Reject : Rejects the incoming call.

i Information

- When an incoming call pop-up is displayed, most Audio and SETUP mode features are disabled. Only the call volume will operate.
- The telephone number may not be properly displayed in some mobile phones.
- When a call is answered with the mobile phone, the call mode will automatically revert to Private mode.

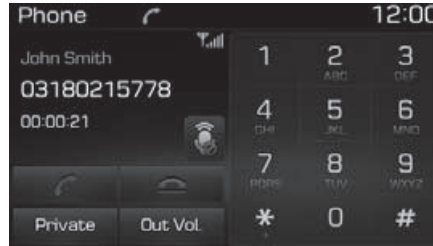

During a Handsfree Call

- Caller : Displays the other party's name if the incoming caller is saved within your phone book.
- Incoming Number : Displays the incoming number.
- Call time : Displays the call time.
- End : Ends call.
- Private : Converts to Private mode.
- Out Vol. : Sets call volume as heard by the other party.
- Mute : Turns Mic Mute On/Off.

i Information

If the mic is muted, the other party will not be able to hear your voice.



Call History

A list of incoming, outgoing and missed calls is displayed.

Press the [Download] button to download the call history.

- Call History :
 - Displays recent calls (call history).
 - Connects call upon selection.
- Download : Download Recent Call History.

i Information

- The call history list will display up to 50 outgoing, incoming, and missed calls.
- Upon downloading call histories, previously saved histories are deleted.
- Incoming calls with hidden caller IDs will not be saved in the call history list.
- Previously saved phone book entries are stored even if a device is disconnected and re-connected.
- The download feature may not be supported in some mobile phones. Check to see that the *Bluetooth*[®] Wireless Technology device supports the download feature.

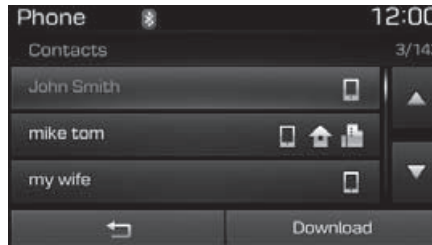

Phone Book

The list of saved phone book entries is displayed. Press the [Download] button to download the call history.

- Contact List :
 - Displays downloaded phone book entries.
 - Connects call upon selection.
- Download : Download phone book entries.

i Information

- Up to 1,000 phone book entries can be copied into car phone book.
- Upon downloading phone book data, previously saved phone book data will be deleted.
- Downloading is not possible if the phone book download feature is turned off within the *Bluetooth*[®] Wireless Technology device. Also, some devices may require device authorization upon attempting to download. If downloading cannot be normally conducted, check the *Bluetooth*[®] Wireless Technology device setting or the screen state.
- Caller ID information will not be displayed for unsaved callers.
- The download feature may not be supported in some mobile phones. Check to see that the *Bluetooth*[®] Wireless Technology device supports the download feature.

Bluetooth® Wireless Technology (Type B-5, Type B-6)

When No Devices have been Paired

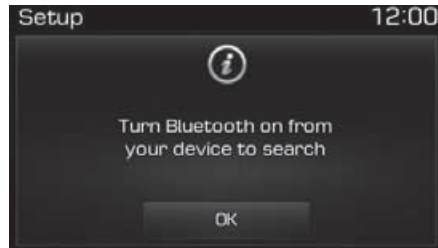

- ① Press the **[PHONE]** button or the **[CALL]** button on the steering wheel controls. The following screen is displayed.
- ② Press the [OK] button to enter the Pair Phone screen.

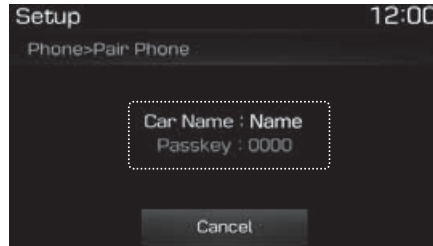

- Car Name : Name of device as shown when searching from your Bluetooth® Wireless Technology device
 - Passkey : Passkey used to pair the device
- ③ From your Bluetooth® Wireless Technology device (i.e. Mobile Phone), search and select your car audio system.

※ SSP : Secure Simple Pairing

Non SSP supported device :

- ④ After a few moments, a screen is displayed where the passkey is entered.
Enter the passkey “0000” to pair your Bluetooth® Wireless Technology device with the car audio system.

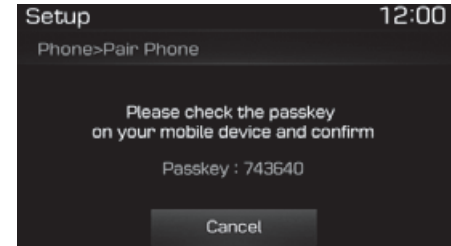

SSP supported device :

- ④ After a few moments, a screen is displayed 6 digits passkey.
Check the passkey on your Bluetooth® Wireless Technology device and confirm.
- ⑤ Once pairing is complete, the following screen is displayed.

Some phones (i.e., iPhone®, Android and Blackberry phones) may offer an option to allow acceptance of all future Bluetooth® connection requests by default." and "Visit <http://www.Hyundai.com/#/bluetooth> for additional information on pairing your Bluetooth®-enabled mobile phone, and to view a phone compatibility list.

i Information

If *Bluetooth*® Wireless Technology devices are paired but none are currently connected, pressing the [PHONE] button or the [CALL] button on the steering wheel controls displays the following screen. Press the [Pair] button to pair a new device or press the [Connect] to connect a previously paired device.

Pairing through [PHONE] Setup

Press the [SETUP] button ► Select [Phone]

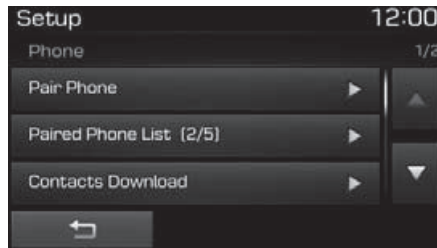
**Pair Phone**

The following steps are the same as those described in the section “When No Devices have been Paired” on the previous page.

i Information

- The waiting period during phone pairing will last for one minute. The pairing process will fail if the device is not paired within the given time. If the pairing process fails, you must start the process from the beginning.
- Generally, most *Bluetooth*® Wireless Technology devices will automatically connect once pairing is complete. However, some devices may require a separate verification process to connect. Check to see whether *Bluetooth*® Wireless Technology has been properly connected within your mobile phone.
- List of paired *Bluetooth*® Wireless Technology devices can be viewed at [SETUP] ► [Phone] ► [Paired Phone List].

Paired Phone List

Press the [SETUP] button ► Select [Phone] ► Select [Paired Phone List]

- Connected Phone : Device that is currently connected.
- Paired Phone : Device that is paired but not connected.

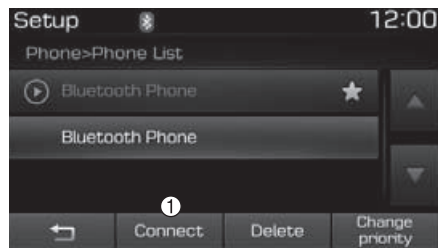

Connecting a Device

From the paired phone list, select the device you want to connect and press the [Connect](1) button.

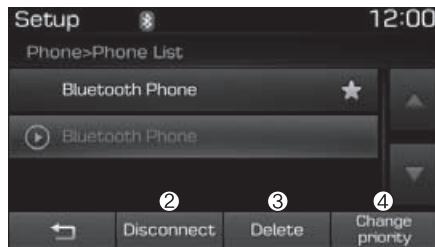

Disconnecting a Device

From the paired phone list, select the currently connected device and press the [Disconnect](2) button.

Deleting a Device

From the paired phone list, select the device you want to delete and press the [Delete](3) button.

i Information

- **When deleting the currently connected device, the device will automatically be disconnected to proceed with the deleting process.**
- **If a paired *Bluetooth*[®] Wireless Technology device is deleted, the device's call history and contacts data will also be deleted.**
- **To re-use a deleted device, you must pair the device again.**

Changing Priority

It is possible to pair up to five *Bluetooth*[®] Wireless Technology devices with the car audio system. The "Change Priority" feature is used to set the connection priority of paired phones. However, the most recently connected phone will always be set as the highest priority.

From the paired phone list, select the phone you want to switch to the highest priority, then press the [Change priority](4) button. The selected device will be changed to the highest priority.

When a device is currently connected, even if you change the priority to a different device, the currently connected phone will always be set as the highest priority.

Phone Menu Screen



Phone Menus

With a *Bluetooth*® Wireless Technology device connected, press the **[PHONE]** button to display the Phone menu screen.

- **Dial Number** : Displays the dial screen where numbers can be dialed to make calls.
- **Call History** : Displays the call history list screen.
- **Contacts** : Displays the Contacts list screen.
- **Setup** : Displays Phone related settings.

i Information

- If you press the **[Call History]** button but there is no call history data, a prompt is displayed which asks whether to download call history data.
- If you press the **[Contacts]** button but there is no contacts data stored, a prompt is displayed which asks whether to download contacts data.
- This feature may not be supported in some mobile phones. For more information on download support, refer to your mobile phone user's manual.

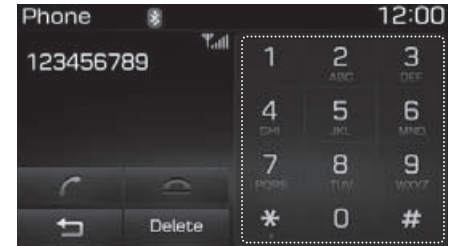

Calling by Dialing a Number

- **Dial Pad** : Used to enter phone number.
- **Call** : If a number has been entered, calls the number. If no number has been entered, switches to call history screen.
- **End** : Deletes the entered phone number.
- **Delete** : Deletes entered numbers one digit at a time.

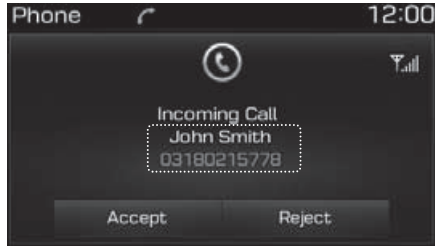

Answering a Call

Answering a call with a *Bluetooth*® Wireless Technology device connected will display the following screen.

- Caller : Displays the other party's name when the incoming caller is saved within your contacts.
- Incoming Number : Displays the incoming number.
- Accept : Accepts the incoming call.
- Reject : Rejects the incoming call.

i Information

- When an incoming call pop-up is displayed, most Audio and SETUP mode features are disabled. Only the call volume will operate.
- The telephone number may not be properly displayed in some mobile phones.
- When a call is answered with the mobile phone, the call mode will automatically revert to Private mode.

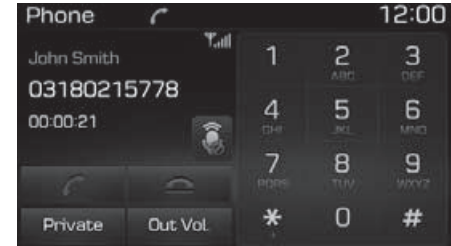

During a Handsfree Call

- Caller : Displays the other party's name if the incoming caller is saved within your contacts.
- Incoming Number : Displays the incoming number.
- Call time : Displays the call time.
- End : Ends call.
- Private : Converts to Private mode.
- Out Vol. : Sets call volume as heard by the other party.
- Mute : Turns Mic Mute On/Off.

i Information

If the mic is muted, the other party will not be able to hear your voice.

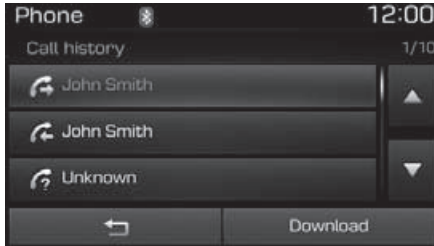

Call History

A list of incoming, outgoing and missed calls is displayed.

Press the [Download] button to download the call history.

- Call History :
 - Displays recent calls (call history).
 - Connects call upon selection.
- Download : Download Recent Call History.

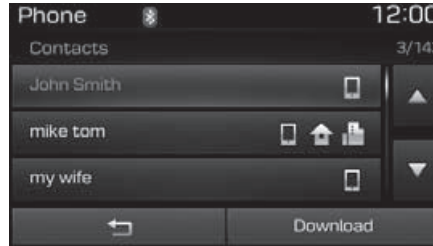

Contacts

The list of saved phone book entries is displayed. Press the [Download] button to download the call history.

- Contacts List :
 - Displays downloaded contacts entries.
 - Connects call upon selection.
- Download : Download contacts entries.

i Information

- Up to 1,000 contacts entries can be copied into car contacts.
- Upon downloading contacts data, previously saved contacts data will be deleted.
- Downloading is not possible if the contacts download feature is turned off within the *Bluetooth*[®] Wireless Technology device. Also, some devices may require device authorization upon attempting to download. If downloading cannot be normally conducted, check the *Bluetooth*[®] Wireless Technology device setting or the screen state.
- Caller ID information will not be displayed for unsaved callers.
- The download feature may not be supported in some mobile phones. Check to see that the *Bluetooth*[®] Wireless Technology device supports the download feature.

Setup Mode (Type B-1, Type B-2, Type B-3, Type B-4)

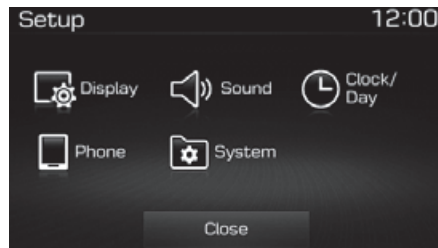

Press the **[SETUP]** button to display the Setup screen.

You can select and control options related to [Display], [Sound], [Clock/Day], [Phone] and [System].

With the Display Button

Press the **[SETUP]** button ► Select [Display]

You can select and control options related to [Brightness], [Pop-up Mode], [Scroll text] and [Song Info].

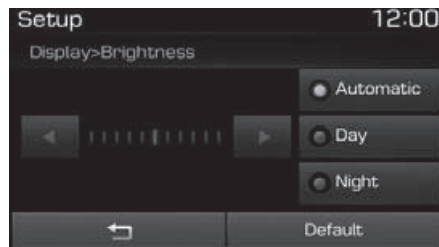

Adjusting the Brightness

Use the [Left/Right] buttons to adjust the screen brightness or set the Brightness on Automatic, Day or Night mode.

Press the [Default] button to reset.

- Automatic : Adjusts the brightness automatically.
- Day : Always maintains the brightness on high.
- Night : Always maintains the brightness on low.

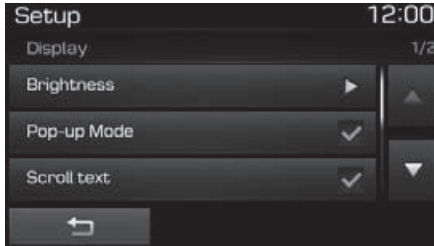

Pop-up Mode

This feature is used to display the Pop-up Mode screen when entering radio and media modes.

When this feature is turned on, pressing the **[RADIO]** or **[MEDIA]** button will display the Pop-up Mode screen.

Information

The media Pop-up Mode screen can be displayed only when two or more media modes have been connected.

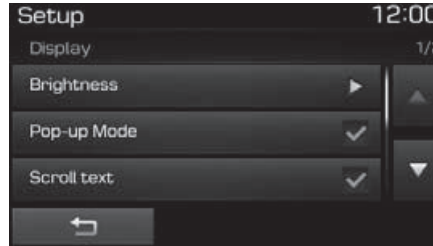

Scroll Text

This feature is used to scroll text displayed on the screen when it is too long to be displayed at once.

When turned on, the text is repeatedly scrolled. When turned off, the text is scrolled just once.

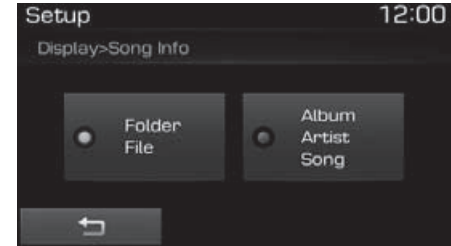

Song Info

This feature is used to change the information displayed within USB and MP3 CD modes.

- Folder File : Displays file name and folder name.
- Album Artist Song : Displays album name/artist name/song.

With the Sound Button

Press the [SETUP] button ► Select [Sound]

You can select and control options related to [Audio Settings], [Speed Dependent Vol.] and [Touch Screen Beep].



Audio Settings

Use the [Up/Down/Left/Right] buttons to adjust the Fader/Balance settings.

Use the [Left/Right] buttons to adjust the Bass/Middle/Treble settings.

Press the [Default] button to reset.

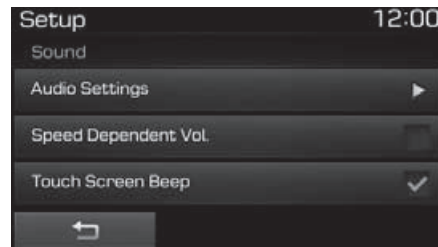

SDVC (Speed Dependent Volume Control)

The volume level is controlled automatically according to the vehicle speed. SDVC can be set by selecting from On/Off.

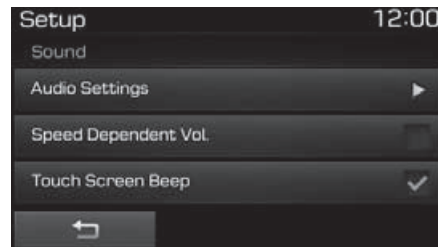

Touch Screen Beep

This feature is used to turn the touch screen beep on/off.

With the Clock/Day Button

Press the **[SETUP]** button ► Select [Clock/Day]

You can select and control options related to [Clock Settings], [Day Settings], [Time Format], [Clock Display(Power off)] and [Automatic RDS Time].



Clock Settings

Use the [Up/Down] buttons to set the Hour, Minutes and AM/PM setting.

Press and hold the **[CLOCK]** button to display the Clock/Day screen.

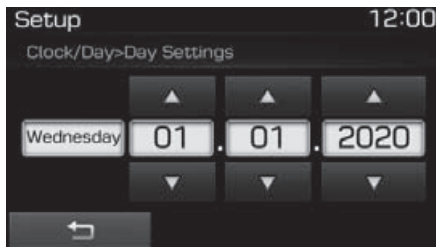

Day Settings

Use the [Up/Down] buttons to set the Day, Month and Year setting.

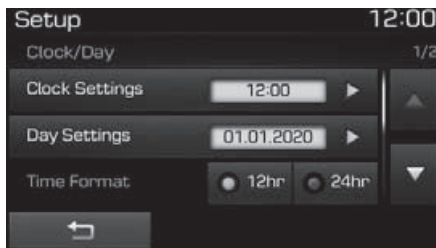

Time Format

This feature is used to change the clock format between 12hr or 24hr.

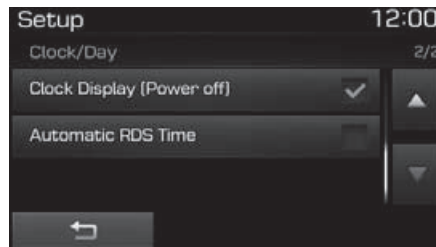

Clock Display (Power Off)

This feature is used to display a clock on the screen when the audio system is turned off.

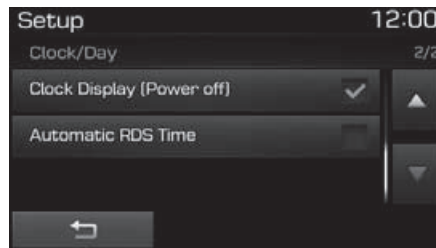

Automatic RDS Time

This feature is used to set time automatically by synchronizing with RDS.

With the Phone Button

Press the [SETUP] button ► Select [Phone]

You can select and control options related to [Pair Phone], [Paired Phone List], [Phone book Download], [Auto Download], [Outgoing Volume] and [Bluetooth System Off].

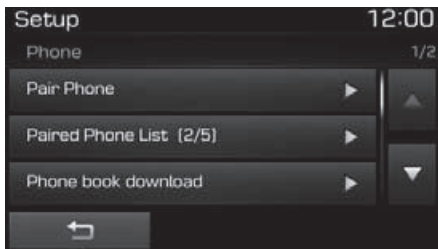

Pairing a New Device

Bluetooth® Wireless Technology devices can be paired with the audio system.

For more information, refer to the “Pairing through Phone Setup” section within Bluetooth® Wireless Technology.

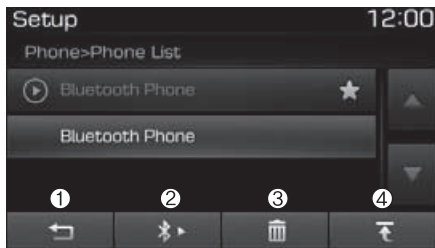

Viewing Paired Phone List

Press the [SETUP] button ► Select [Phone] ► Select [Paired Phone List]

This feature is used to view mobile phones that have been paired with the audio system. Upon selecting a paired phone, the setup menu is displayed.

For more information, refer to the “Setting Bluetooth® Wireless Technology Connection” section within Bluetooth® Wireless Technology.

- (1) Moves to the previous screen.
- (2) Connect/Disconnects currently selected phone.
- (3) Deletes the currently selected phone.
- (4) Sets currently selected phone to highest connection priority.

i Information

- Before Downloading Phone Books

- Only phone books within connected phones can be downloaded. Also check to see that your mobile phone supports the download feature.
- To learn more about whether your mobile phone supports phone book downloads, refer to your mobile phone user’s manual.
- The Phone book for only the connected phone can be downloaded. Before downloading, check to see whether your phone supports the download feature.

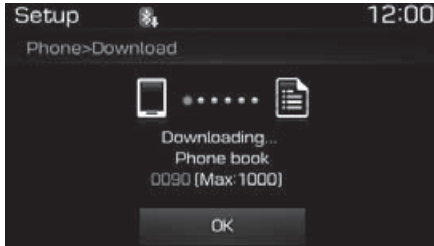

Downloading Phone books

As the Phone book is downloaded from the mobile phone, downloading Phone book number is displayed.

- Up to 1,000 phone book entries can be copied into car phone book.
- Up to 1,000 phone book entries can be saved for each paired device.
- Upon downloading phone book data, previously saved phone book data will be deleted. However, Phone book entries saved to other paired phones are not deleted.

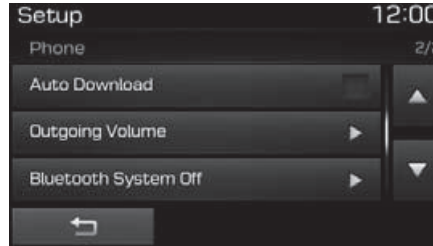

Auto Download (Phone Book)

This feature is used to automatically download mobile phone book entries once a *Bluetooth*[®] Wireless Technology phone is connected.

- The Auto Download feature will download mobile phone book entries every time the phone is connected. The download time may differ depending on the number of saved phone book entries and the communication state.
- When downloading a phone book, first check to see that your mobile phone supports the phone book download feature.



Outgoing Volume

Use the [-], [+] buttons to adjust the outgoing volume level.

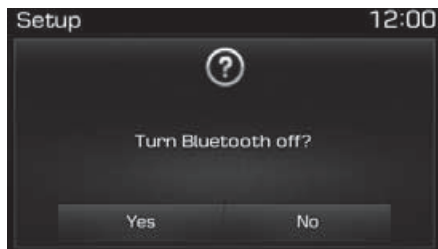
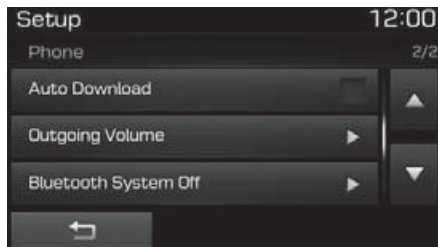

Turning Bluetooth System Off

Once *Bluetooth*® Wireless Technology is turned off, *Bluetooth*® Wireless Technology related features will not be supported within the audio system.

To turn *Bluetooth*® Wireless Technology back on, go to **[SETUP]** ► **[Phone]** and press “Yes”.

NOTICE

***Bluetooth*® Wireless Technology audio streaming may not be supported in some *Bluetooth*® Wireless Technology phones.**

With the System Button

Press the **[SETUP]** button ► Select **[System]**

You can select and control options related to **[Memory Information]** and **[Language]**.

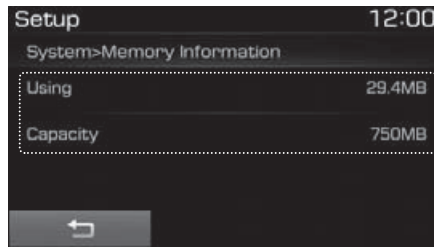

Memory Information

This feature displays information related to system memory.

- Using : Displays capacity currently in use
- Capacity : Displays total capacity

* May differ depending on the selected audio.

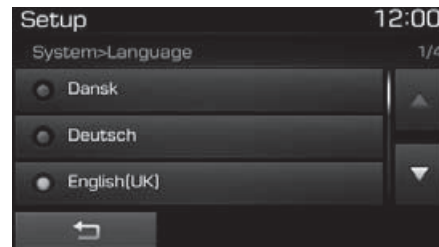

Language

This feature is used to change the system and voice recognition language.

If the language is changed, the system will restart and apply the selected language.

- Language support by region
Dansk, Deutsch, English(UK), Español, Français, Italiano, Nederlands, Русский, Polski, Svenska, Türkçe.

Setup Mode (Type B-5, Type B-6)



Press the **[SETUP]** button to display the Setup screen.

You can select and control options related to [Display], [Sound], [Clock/Calendar], [Phone] and [System].

With the Display Button

Press the **[SETUP]** button ► Select [Display]

You can select and control options related to [Brightness], [Mode Pop up], [Text Scroll] and [Media Display].

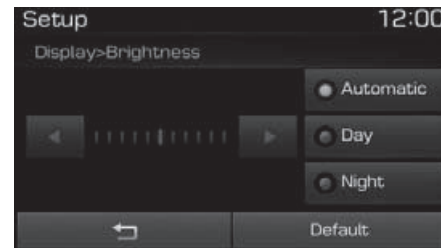

Adjusting the Brightness

Use the [Left/Right] buttons to adjust the screen brightness or set the Brightness on Automatic, Day or Night mode.

Press the [Default] button to reset.

- Automatic : Adjusts the brightness automatically.
- Day : Always maintains the brightness on high.
- Night : Always maintains the brightness on low.

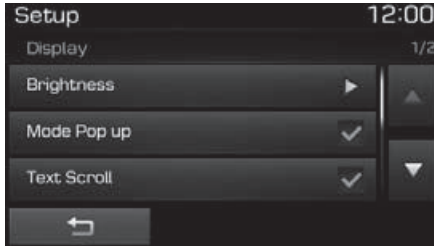

Mode Pop up

This feature is used to display the Mode Pop up screen when entering radio and media modes.

When this feature is turned on, pressing the **[RADIO]** or **[MEDIA]** button will display the Mode Pop up screen.

Information

The media Mode Pop up screen can be displayed only when two or more media modes have been connected.

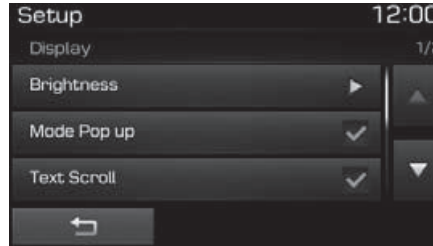

Text Scroll

This feature is used to scroll text displayed on the screen when it is too long to be displayed at once.

When turned on, the text is repeatedly scrolled. When turned off, the text is scrolled just once.



Media Display

This feature is used to change the information displayed within USB and MP3 CD modes.

- Folder File : Displays file name and folder name.
- Album Artist Song : Displays album name/artist name/song.

With the Sound Button

Press the **[SETUP]** button ► Select **[Sound]**

You can select and control options related to **[Sound Setting]**, **[Speed Dependent Vol.]** and **[Touch Screen Beep]**.



Sound Setting

Use the **[Up/Down/Left/Right]** buttons to adjust the **Fader/Balance** settings.

Use the **[Left/Right]** buttons to adjust the **Bass/Middle/Treble** settings.

Press the **[Default]** button to reset.

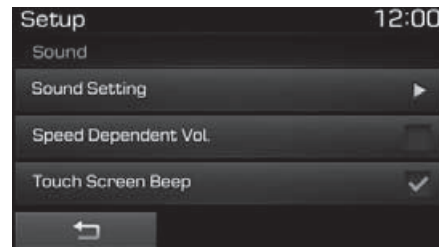

SDVC (Speed Dependent Volume Control)

The volume level is controlled automatically according to the vehicle speed. SDVC can be set by selecting from **On/Off**.

Touch Screen Beep

This feature is used to turn the touch screen beep on/off.

With the Clock/Calendar Button

Press the **[SETUP]** button ► Select [Clock/Calendar]

You can select and control options related to [Clock Settings], [Calendar Settings] and [Clock Display(Power off)].



Clock Settings

Use the [Up/Down] buttons to set the Hour, Minutes and AM/PM setting.

Press and hold the **[CLOCK]** button to display the Clock/Calendar screen.

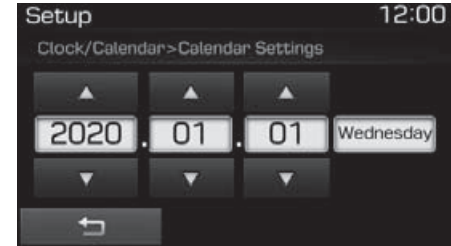

Calendar Settings

Use the [Up/Down] buttons to set the Year, Month and Day setting.

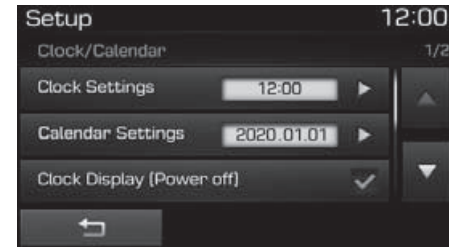

Clock Display(Power off)

This feature is used to display a clock on the screen when the audio system is turned off.

With the Phone Button

Press the **[SETUP]** button ► Select [Phone]

You can select and control options related to [Pair Phone], [Paired Phone List], [Contacts Download], [Auto Download], [Outgoing Volume] and [Bluetooth System Off].

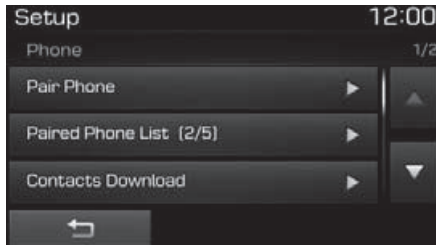

Pairing a New Device

Bluetooth[®] Wireless Technology devices can be paired with the audio system.

For more information, refer to the "Pairing through Phone Setup" section within *Bluetooth*[®] Wireless Technology.

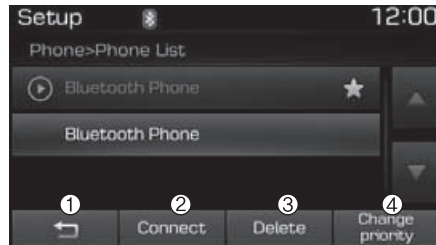

Viewing Paired Phone List

This feature is used to view mobile phones that have been paired with the audio system. Upon selecting a paired phone, the setup menu is displayed.

For more information, refer to the "Setting *Bluetooth*[®] Wireless Technology Connection" section within *Bluetooth*[®] Wireless Technology.

- (1) Moves to the previous screen.
- (2) Connect/disconnects currently selected phone.
- (3) Deletes the currently selected phone.
- (4) Sets currently selected phone to highest connection priority.

i **Information**
**- Before Downloading
Contacts**

- To learn more about whether your mobile phone supports contacts downloads, refer to your mobile phone user's manual.
- The contacts for only the connected phone can be downloaded.



Downloading Contacts

As the contacts are downloaded from the mobile phone, downloading contacts number is displayed.

- Up to 1,000 contacts entries can be copied into car contacts.
- Up to 1,000 contacts entries can be saved for each paired device.
- Upon downloading contacts data, previously saved contacts data will be deleted. However, contacts entries saved to other paired phones are not deleted.

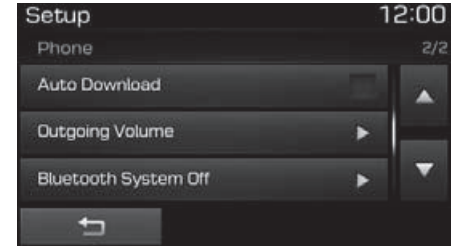

Auto Download (Contacts)

This feature is used to automatically download mobile contacts entries once a *Bluetooth®* Wireless Technology phone is connected.

- The Auto Download feature will download mobile contacts entries every time the phone is connected. The download time may differ depending on the number of saved contacts entries and the communication state.
- When downloading a contacts, first check to see that your mobile phone supports the contacts download feature.

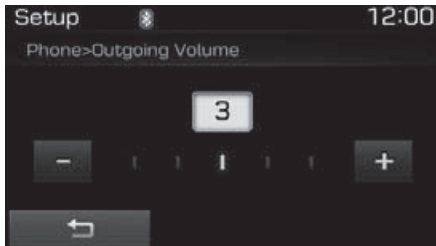

Outgoing Volume

Use the [-], [+] buttons to adjust the outgoing volume level.

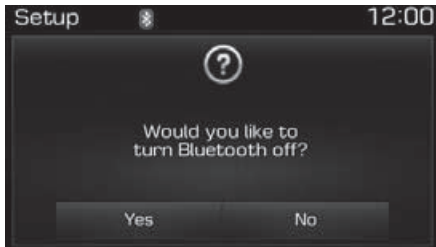

Turning Bluetooth System Off

Once *Bluetooth*® Wireless Technology is turned off, *Bluetooth*® Wireless Technology related features will not be supported within the audio system.

To turn *Bluetooth*® Wireless Technology back on, go to [SETUP] ► [Phone] and press “Yes”.

With the System Button

Press the [SETUP] button ► Select [System]

You can select and control options related to [Memory Information] and [Language].

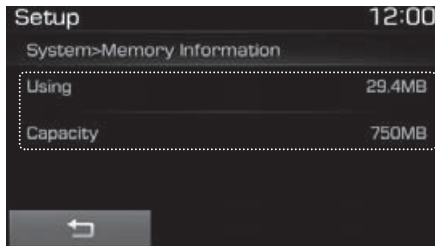

Memory Information

This feature displays information related to system memory.

- Using : Displays capacity currently in use
- Capacity : Displays total capacity

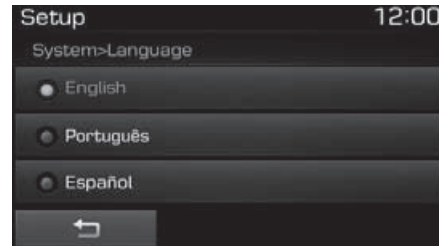

Language

This feature is used to change the system language.

If the language is changed, the system will restart and apply the selected language.

- Language support by region.
English, Português, Español.

Declaration of Conformity

FCC

This equipment has been tested and found to comply with the limits for a Class B digital device, pursuant to part 15 of the FCC Rules. These limits are designed to provide reasonable protection against harmful interference in a residential installation.

This equipment generates, uses and can radiate radio frequency energy and, if not installed and used in accordance with the instructions, may cause harmful interference to radio communications. However, there is no guarantee that interference will not occur in a particular installation. If this equipment does cause harmful interference to radio or television reception, which can be determined by turning the equipment off and on, the user is encouraged to try to correct the interference by one or more of the following measures :

- Reorient or relocate the receiving antenna.
- Increase the separation between the equipment and receiver.
- Connect the equipment into an outlet on a circuit different from that to which the receiver is connected.
- Consult the dealer or an experienced radio/TV technician for help.

Caution : Any changes or modifications to this device not explicitly approved by manufacturer could void your authority to operate this equipment.

This device complies with part 15 of the FCC Rules. Operation is subject to the following two conditions :

(1) This device may not cause harmful interference, and (2) this device must accept any interference received, including interference that may cause undesired operation.

This equipment complies with FCC radiation exposure limits set forth for an uncontrolled environment.

This equipment should be installed and operated with minimum 20cm between the and your body. This transmitter must not be collocated or operating in conjunction with any other antenna or transmitter unless authorized to do so by the FCC.

CE for EU

Declaration of Conformity

We, manufacturer, hereby declare that the product

Model: AC112F2EE, AC110F2GG, AC110F2GN, AC110F2GE, AC110F2GL, AC111F2GG,
AC111F2GE, AC110F2EE
Type: DIGITAL CAR AUDIO SYSTEM

satisfies all the technical regulations applicable to the product within the scope of Council Directives 2006/95/EC, 2004/108/EC and 99/5/EC:

Radio: EN 300 328 V.1 & 1/(2012-06)
EMC: EN 55013 - 2013
EN 55020 - 2007 / A11 - 2011
ETSI EN 301 489-1 V.1.9.2
ETSI EN 301 489-17 V.2.2.1
Safety: EN 60065:2002 + A1:2006 + A11:2008 + A2:2010 + A12:2011

All essential radio test suites have been carried out.

Testing laboratory: DT&C Co., Ltd.

42, Yurim-ro, 154beon-gil, Cheoin-gu, Yongsin-si, Gyeonggi-do, Korea, 449-935
Tel. +82 31 321 2664 / Fax. +82 31 321 1964

Authorized representative or manufacturer:

HYUNDAI MOBIS Co., Ltd.
203, Teheran-ro, Gangnam-gu, Seoul, 135-977, Korea.
Tel. 82-31-260-0098 / Fax. 82-31-899-1788

This declaration is issued under the sole responsibility of the manufacturer and, if applicable, his authorized Representative, and is marked in accordance with the CE marking directive 93/68/EEC.

Point of contact :

HYUNDAI MOBIS Co., Ltd. Tel. 82-31-260-0098 / Fax. 82-31-899-1788

Seoul, Korea March 31, 2015



최능훈

/ S. H. Choe
/ Director

Declaration of Conformity

We, manufacturer, hereby declare that the product

Model: AM112F2EE, AM110F2GG, AM110F2GN, AM110F2GE, AM110F2GL, AM111F2GG,
AM111F2GE, AM110F2EE
Type: DIGITAL CAR AUDIO SYSTEM

satisfies all the technical regulations applicable to the product within the scope of Council Directives 2006/95/EC, 2004/108/EC and 99/5/EC:

Radio: EN 300 328 V.1 & 1/(2012-06)
EMC: EN 55013 - 2013
EN 55020 - 2007 / A11 - 2011
ETSI EN 301 489-1 V.1.9.2
ETSI EN 301 489-17 V.2.2.1
Safety: EN 60065:2002 + A1:2006 + A11:2008 + A2:2010 + A12:2011

All essential radio test suites have been carried out.

Testing laboratory: DT&C Co., Ltd.

42, Yurim-ro, 154beon-gil, Cheoin-gu, Yongsin-si, Gyeonggi-do, Korea, 449-935
Tel. +82 31 321 2664 / Fax. +82 31 321 1964

Authorized representative or manufacturer:

HYUNDAI MOBIS Co., Ltd.
203, Teheran-ro, Gangnam-gu, Seoul, 135-977, Korea.
Tel. 82-31-260-0098 / Fax. 82-31-899-1788

This declaration is issued under the sole responsibility of the manufacturer and, if applicable, his authorized Representative, and is marked in accordance with the CE marking directive 93/68/EEC.

Point of contact :

HYUNDAI MOBIS Co., Ltd. Tel. 82-31-260-0098 / Fax. 82-31-899-1788

Seoul, Korea March 31, 2015



최능훈

/ S. H. Choe
/ Director

Declaration of Conformity

We, manufacturer, hereby declare that the product

Model: AM21F2EE, AM210F2GG, AM210F2GN, AM210F2GE, AM210F2GL, AM211F2GG,
AM211F2GE, AM210F2EE
Type: DIGITAL CAR AUDIO SYSTEM

satisfies all the technical regulations applicable to the product within the scope of Council Directives 2006/95/EC, 2004/108/EC and 99/5/EC:

Radio: EN 300 328 V.1 & 1(2012-06)
EMC: EN 55013, 2013
EN 55020 - 2007 / A11 - 2011
ETSI EN 301 489-1 V.1 & 2
ETSI EN 301 489-17 V.2.2.1
Safety: EN 60969:2002 + A1:2006 + A11:2008 + A2:2010 + A12:2011

All essential radio test suites have been carried out.

Testing laboratory: DT&C Co., Ltd.

42, Yurim-ro, 154beon-gil, Cheoin-gu, Yongin-si, Gyeonggi-do, Korea, 449-935
Tel. +82 31 321 2664 / Fax. +82 31 321 1964

Authorized representative or manufacturer:

HYUNDAI MOBIS Co., Ltd.
203, Teheran-ro, Gangnam-gu, Seoul, 135-977, Korea
Tel. 82-31-260-0098 / Fax. 82-31-899-1788

This declaration is issued under the sole responsibility of the manufacturer and, if applicable, his authorized Representative, and is marked in accordance with the CE marking directive 93/68/EEC.

Point of contact :

HYUNDAI MOBIS Co., Ltd. Tel. 82-31-260-0098 / Fax. 82-31-899-1788

Seoul, Korea March 31, 2015



최승훈

/ S. H. Choe
/ Director

NCC for Taiwan

根據交通部低功率電波輻射性電機管理辦法 規定：	
第十二條	經型式認證合格之低功率射頻電機，非經許可，公司、商號或使用者均不得擅自變更頻率、加大功率或變更原設計之特性及功能。
第十四條	低功率射頻電機之使用不得影響飛航安全及干擾合法通信；經發現有干擾現象時，應立即停用，並改善至無干擾時方得繼續使用。 前項合法通信，指依電信法規定作業之無線電通信。 低功率射頻電機須忍受合法通信或工業、科學及醫療用電波輻射性電機設備之干擾。

ACMA for Australia

Declaration of Conformity

We, manufacturer, hereby declare that the product

Model: AC112F2EE, AC100F2GG, AC110F2GN, AC100F2GN, AC100F2GG,
AC110F2GE, AC100F2GL, AC110F2GL, AC101F2GG, AC111F2GG, AC101F2GE, AC111F2GE,
AC100F2EE, AC110F2EE, AC102F2EE
Type: DIGITAL CAR AUDIO SYSTEM

satisfies all the technical regulation applicable to the product within the standards of Australia and New Zealand :

Radio: AS/NZS 4771:2000
EMC: AS/NZS CISPR13:2012



All essential test suites have been carried out.

Testing laboratory: D&C Co., Ltd.
42, Yurim-ro, 154beon-gil, Cheoin-gu, Yongin-si, Gyeonggi-do, Korea, 449-935
Tel. +82 31 321 2664 / Fax. +82 31 321 1664

Authorized representative or manufacturer:
Hyundai Mobis Co., Ltd.
203, Teheran-ro, Gangnam-gu, Seoul, 135-977, Korea
Jincheon plant 95, Sayang 2-Gil, Munsan-Myeon, Jincheon-Gun, Chungcheongbuk-Do 365-862 Korea
Tel. 82-31-260-0098 / Fax. 82-31-899-1788

This declaration is issued under the sole responsibility of the manufacturer and, if applicable, his authorised representative.

Point of contact:
Hyundai Mobis Co., Ltd. Tel. 82-31-260-0098 / Fax. 82-31-899-1788
Seoul, Korea May 07, 2015.

 
/ S. H. Choe
/ Director

NXXX

Declaration of Conformity

We, manufacturer, hereby declare that the product

Model: AM112F2EE, AM110F2GG, AM110F2GN, AM110F2GE, AM110F2GL, AM111F2GG,
AM111F2GE, AM110F2EE
Type: DIGITAL CAR AUDIO SYSTEM

satisfies all the technical regulation applicable to the product within the standards of Australia and New Zealand :

Radio: AS/NZS 4771:2000
EMC: AS/NZS CISPR13:2012



All essential test suites have been carried out.

Testing laboratory: D&C Co., Ltd.
42, Yurim-ro, 154beon-gil, Cheoin-gu, Yongin-si, Gyeonggi-do, Korea, 449-935
Tel. +82 31 321 2664 / Fax. +82 31 321 1664

Authorized representative or manufacturer:
Hyundai Mobis Co., Ltd.
203, Teheran-ro, Gangnam-gu, Seoul, 135-977, Korea
Jincheon plant 95, Sayang 2-Gil, Munsan-Myeon, Jincheon-Gun, Chungcheongbuk-Do 365-862 Korea
Tel. 82-31-260-0098 / Fax. 82-31-899-1788

This declaration is issued under the sole responsibility of the manufacturer and, if applicable, his authorised representative.

Point of contact:
Hyundai Mobis Co., Ltd. Tel. 82-31-260-0098 / Fax. 82-31-899-1788
Seoul, Korea May 07, 2015.

 
/ S. H. Choe
/ Director

NXXX

Declaration of Conformity

We, manufacturer, hereby declare that the product

Model: AM212F2EE, AM210F2GG, AM210F2GN, AM210F2GE, AM210F2GL, AM211F2GG,
AM211F2GE, AM210F2EE
 Type: DIGITAL CAR AUDIO SYSTEM

satisfies all the technical regulation applicable to the product within the standards of Australia and New Zealand :

Radio: AS/NZS 4771:2000

EMC: AS/NZS CISPR13:2012

All essential test suites have been carried out.

Testing laboratory: DT&C Co., Ltd.

42, Yurim-ro, 154beon-gil, Cheoin-gu, Yonoin-si, Gyeonggi-do, Korea, 449-935
Tel. +82 31 321 2664 / Fax. +82 31 321 1864

Authorized representative or manufacturer:

Hyundai Mobis Co., Ltd.
200, Tahwang-ro, Gajigam-gu, Seoul, 135-877, Korea
Incheon plant 95, Sayang 2-Gil, Munbaek-Myeon, Incheon-Gun, Chungcheongbuk-Do 365-862 Korea
Tel. 82-31-260-0099 / Fax. 82-31-899-1788

This declaration is issued under the sole responsibility of the manufacturer and, if applicable, his authorised representative.

Point of contact:

Hyundai Mobis Co., Ltd. Tel. 82-31-260-0099 / Fax. 82-31-899-1788
Seoul, Korea May 07, 2015.



NXXX

최승훈

/ S. H. Cho
 / Director

ANATEL for Brazil

ANATEL Homologation

Hyundai MOBIS Co., Ltd.
AC110F2GN

“Este produto está homologado pela ANATEL, de acordo com os procedimentos regulamentados pela resolução nº . 242/2000 e atende aos requisitos técnicos e aplicados”

“Este equipamento opera em caráter secundário, isto é, não tem direito a proteção contra interferência prejudicial, mesmo de estações do mesmo tipo, e não pode causar interferência a sistemas operando em caráter primário.”

Para maiores informações, consulte o site da ANATEL
www.anatel.gov.br

Modelo : **AC110F2GN**



ANATEL Homologation

Hyundai MOBIS Co., Ltd.
AM110F2GN

“Este produto está homologado pela ANATEL, de acordo com os procedimentos regulamentados pela resolução nº . 242/2000 e atende aos requisitos técnicos e aplicados”

“Este equipamento opera em caráter secundário, isto é, não tem direito a proteção contra interferência prejudicial, mesmo de estações do mesmo tipo, e não pode causar interferência a sistemas operando em caráter primário.”

Para maiores informações, consulte o site da ANATEL
www.anatel.gov.br

Modelo : **AM110F2GN**



ANATEL Homologation

Hyundai MOBIS Co., Ltd.
AM210F2GN

“Este produto está homologado pela ANATEL, de acordo com os procedimentos regulamentados pela resolução nº . 242/2000 e atende aos requisitos técnicos e aplicados”

“Este equipamento opera em caráter secundário, isto é, não tem direito a proteção contra interferência prejudicial, mesmo de estações do mesmo tipo, e não pode causar interferência a sistemas operando em caráter primário.”

Para maiores informações, consulte o site da ANATEL
www.anatel.gov.br

Modelo : **AM210F2GN**



SMA for Jamaica

This product has been Type Approved by Jamaica : SMA-AM210F2GN

This product has been Type Approved by Jamaica : SMA-AM110F2GN

This product has been Type Approved by Jamaica : SMA-AC110F2GN

IFETEL for Mexico

<IFETEL Operation Guide>

“La operación de este equipo está sujeta a las siguientes dos condiciones :
(1) es posible que este equipo o dispositivo no cause interferencia perjudicial y
(2) este equipo o dispositivo debe aceptar cualquier interferencia, incluyendo la que pueda causar su operación no deseada.”

MOC for Israel

מספר אישור אלחוטי של משרד התקשורת הוא 51-48522
אסור להחליף את האנטנה המקורית של המכשיר,
ולא לעשות בו כל שינוי טכני אחר.

מספר אישור אלחוטי של משרד התקשורת הוא 51-48818
אסור להחליף את האנטנה המקורית של המכשיר,
ולא לעשות בו כל שינוי טכני אחר.

Driving your vehicle

Before driving	5-4
Before entering the vehicle	5-4
Before starting.....	5-4
Ignition switch	5-5
Key ignition switch.....	5-6
Engine Start/Stop button.....	5-11
Manual transmission	5-20
Manual transmission operation	5-20
Good driving practices.....	5-22
Automatic transmission	5-24
Automatic transmission operation	5-24
Parking.....	5-29
Good driving practices.....	5-29
Dual clutch transmission	5-31
Dual clutch transmission operation.....	5-31
Parking.....	5-39
Good driving practices.....	5-39
Braking system	5-41
Power brakes	5-41
Disc brakes wear indicator	5-42
Rear drum brakes	5-42
Parking brake	5-42
Anti-lock Brake System (ABS)	5-45
Electronic Stability Control (ESC).....	5-47
Vehicle Stability Management (VSM).....	5-50
Hill-start Assist Control (HAC)	5-52
Emergency Stop Signal (ESS)	5-52
Good braking practices.....	5-53
ISG (Idle Stop and Go) system	5-54
To activate the ISG system.....	5-54
To deactivate the ISG system	5-57
ISG system malfunction.....	5-57
The battery sensor deactivation	5-59
Drive mode integrated control system	5-60
Blind Spot Detection system (BSD)	5-62
BSD (Blind Spot Detection) /	
LCA (Lane Change Assist).....	5-63
RCTA (Rear Cross Traffic Alert)	5-66
Limitations of the system	5-69
Cruise control	5-71
Cruise Control operation	5-71
Special driving conditions	5-78
Hazardous driving conditions.....	5-78
Rocking the vehicle	5-78
Smooth cornering	5-79
Driving at night.....	5-79
Driving in the rain	5-79
Driving in flooded areas.....	5-80
Highway driving.....	5-80

Winter driving	5-81
Snow or icy conditions.....	5-81
Winter Precautions.....	5-83
Trailer towing	5-86
If you decide to pull a trailer	5-87
Trailer towing equipment	5-91
Driving with a trailer	5-92
Maintenance when towing a trailer	5-96
Vehicle weight	5-97
Overloading.....	5-97

WARNING

Carbon monoxide (CO) gas is toxic. Breathing CO can cause unconsciousness and death.

Engine exhaust contains carbon monoxide which cannot be seen or smelled.

Do not inhale engine exhaust.

If at any time you smell engine exhaust inside the vehicle, open the windows immediately. Exposure to CO can cause unconsciousness and death by asphyxiation.

Be sure the exhaust system does not leak.

The exhaust system should be checked whenever the vehicle is raised to change the oil or for any other purpose. If you hear a change in the sound of the exhaust or if you drive over something that strikes the underneath side of the vehicle, we recommend that the exhaust system be checked as soon as possible by an authorized HYUNDAI dealer.

Do not run the engine in an enclosed area.

Letting the engine idle in your garage, even with the garage door open, is a hazardous practice. Run the engine only long enough to start the engine and to move the vehicle out of the garage.

Avoid idling the engine for prolonged periods with people inside the vehicle.

If it is necessary to idle the engine for a prolonged period with people inside the vehicle, be sure to do so only in an open area with the air intake set at "Fresh" and fan control set to high so fresh air is drawn into the interior.

Keep the air intakes clear.

To assure proper operation of the ventilation system, keep the ventilation air intakes located in front of the windshield clear of snow, ice, leaves, or other obstructions.

If you must drive with the trunk open:

Close all windows.

Open instrument panel air vents.

Set the air intake control at "Fresh", the air flow control at "Floor" or "Face", and the fan control set to high.

BEFORE DRIVING

Before entering the vehicle

- Be sure all windows, outside mirror(s), and outside lights are clean and unobstructed.
- Remove frost, snow, or ice.
- Visually check the tires for uneven wear and damage.
- Check under the vehicle for any sign of leaks.
- Be sure there are no obstacles behind you if you intend to back up.

Before starting

- Make sure the hood, the trunk, and the doors are securely closed and locked.
- Adjust the position of the seat and steering wheel.
- Adjust the inside and outside rearview mirrors.
- Verify all the lights work.
- Fasten your seatbelt. Check that all passengers have fastened their seatbelts.
- Check the gauges and indicators in the instrument panel and the messages on the instrument display when the ignition switch is in the ON position.
- Check that any items you are carrying are stored properly or fastened down securely.

WARNING

To reduce the risk of **SERIOUS INJURY** or **DEATH**, take the following precautions:

- **ALWAYS wear your seat belt. All passengers must be properly belted whenever the vehicle is moving. For more information, refer to "Seat Belts" in chapter 2.**
- **Always drive defensively. Assume other drivers or pedestrians may be careless and make mistakes.**
- **Stay focused on the task of driving. Driver distraction can cause accidents.**
- **Leave plenty of space between you and the vehicle in front of you.**

WARNING

NEVER drink or take drugs and drive.

Drinking or taking drugs and driving is dangerous and may result in an accident and **SERIOUS INJURY** or **DEATH**.

Drunk driving is the number one contributor to the highway death toll each year. Even a small amount of alcohol will affect your reflexes, perceptions and judgment. Just one drink can reduce your ability to respond to changing conditions and emergencies and your reaction time gets worse with each additional drink.

Driving while under the influence of drugs is as dangerous or more dangerous than driving under the influence of alcohol.

(Continued)

(Continued)

You are much more likely to have a serious accident if you drink or take drugs and drive. If you are drinking or taking drugs, don't drive. Do not ride with a driver who has been drinking or taking drugs. Choose a designated driver or call a taxi.

IGNITION SWITCH

WARNING

To reduce the risk of **SERIOUS INJURY** or **DEATH**, take the following precautions:

- **NEVER** allow children or any person who is unfamiliar with the vehicle to touch the ignition switch or related parts. Unexpected and sudden vehicle movement can occur.
- **NEVER** reach through the steering wheel for the ignition switch, or any other control, while the vehicle is in motion. The presence of your hand or arm in this area may cause a loss of vehicle control resulting in an accident.

Key ignition switch



OAD055082L

Whenever the front door is opened, the ignition switch will illuminate, provided the ignition switch is not in the ON position. The light will go off immediately when the ignition switch is turned on or go off after about 30 seconds when the door is closed. (if equipped)



OYF059016

WARNING

- **NEVER** turn the ignition switch to the **LOCK** or **ACC** position while the vehicle is in motion except in an emergency. This will result in the engine turning off and loss of power assist for the steering and brake systems. This may lead to loss of directional control and braking function, which could cause an accident.

(Continued)

(Continued)

- Before leaving the driver's seat, always make sure the shift lever is in 1st gear (for manual transmission vehicle) or P (Park, for automatic transmission/dual clutch transmission vehicle) position, apply the parking brake, and turn ignition switch to the **LOCK** position.

Unexpected vehicle movement may occur if these precautions are not followed.

Key ignition switch positions

Switch Position	Action	Notes
LOCK	<p>To turn the ignition switch to the LOCK position, put the key in at the ACC position and turn the key towards the LOCK position.</p> <p>The ignition key can be removed in the LOCK position.</p> <p>The steering wheel locks to protect the vehicle from theft. (if equipped)</p>	
ACC	<p>Electrical accessories are usable.</p> <p>The steering wheel unlocks.</p>	<p>If difficulty is experienced turning the ignition switch to the ACC position, turn the key while turning the steering wheel right and left to release tension.</p>
ON	<p>This is the normal key position when the engine has started.</p> <p>All features and accessories are usable.</p> <p>The warning lights can be checked when you turn the ignition switch from ACC to ON.</p>	<p>Do not leave the ignition switch in the ON position when the engine is not running to prevent the battery from discharging.</p>
START	<p>To start the engine, turn the ignition switch to the START position.</p> <p>The switch returns to the ON position when you let go of the key.</p>	<p>The engine will crank until you release the key.</p>

Starting the engine

WARNING

- **Always wear appropriate shoes when operating your vehicle. Unsuitable shoes, such as high heels, ski boots, sandals, flip-flops, etc., may interfere with your ability to use the brake, accelerator and clutch pedals.**
- **Do not start the vehicle with the accelerator pedal depressed. The vehicle can move and lead to an accident.**
- **Wait until the engine rpm is normal. The vehicle may suddenly move if the brake pedal is released when the rpm is high.**

Starting the gasoline engine

Vehicle with manual transmission:

1. Make sure the parking brake is applied.
2. Make sure the shift lever is in neutral.
3. Depress the clutch and brake pedals.
4. Turn the ignition switch to the START position. Hold the key (maximum of 10 seconds) until the engine starts and release it.

Vehicle with automatic transmission/dual clutch transmission:

1. Make sure the parking brake is applied.
2. Make sure the shift lever is in P (Park).
3. Depress the brake pedal.
4. Turn the ignition switch to the START position. Hold the key (maximum of 10 seconds) until the engine starts and release it.



i Information

- It is best to maintain a moderate engine speed until the vehicle engine comes up to normal operating temperature. Avoid harsh or abrupt acceleration or deceleration while the engine is still cold.
- Always start the vehicle with your foot on the brake pedal. Do not depress the accelerator while starting the vehicle. Do not race the engine while warming it up.



Starting the diesel engine

To start the diesel engine when the engine is cold, it has to be pre-heated before starting the engine and then have to be warmed up before starting to drive.

Vehicle with manual transmission:

1. Make sure the parking brake is applied.
2. Make sure the shift lever is in neutral.
3. Depress the clutch and brake pedals.
4. Turn the ignition switch to the ON position to pre-heat the engine. The glow indicator light () will illuminate.
5. When the glow indicator light () goes out, turn the key ignition switch to the START position. Hold the key (maximum of 10 seconds) until the engine starts and release it.

Vehicle with dual clutch transmission:

1. Make sure the parking brake is applied.
2. Make sure the shift lever is in P (Park).
3. Depress the brake pedal.
4. Turn the ignition switch to the ON position to pre-heat the engine. The glow indicator light () will illuminate.
5. When the glow indicator light () goes out, turn the key ignition switch to the START position. Hold the key (maximum of 10 seconds) until the engine starts and release it.

NOTICE

If the engine does not start within 10 seconds after preheating is completed, turn the ignition switch once more to the LOCK position and wait for 10 seconds. Then turn the ignition switch to the ON position in order to pre-heat the engine again.

Starting and stopping the engine for turbocharger intercooler

1. Do not race or accelerate the engine immediately after starting the engine.

If the engine is cold, idle for several seconds before sufficient lubrication is ensured in the turbo charger unit.

2. After high speed or extended driving that requires heavy engine load, idle the engine about 1 minute before turning the engine off.

This idle time will allow the turbocharger to cool prior to shutting the engine off.

NOTICE

Do not turn off the engine immediately after it has been subjected to a heavy load. Doing so may cause severe damage to the engine or turbo charger unit.

NOTICE

To prevent damage to the vehicle:

- Do not hold the ignition key in the START position for more than 10 seconds. Wait 5 to 10 seconds before trying again.
- Do not turn the ignition switch to the START position with the engine running. It may damage the starter.
- If traffic and road conditions permit, you may put the shift lever in the N (Neutral) position while the vehicle is still moving and turn the ignition switch to the START position in an attempt to restart the engine.
- Do not push or tow your vehicle to start the engine.

Engine Start/Stop button

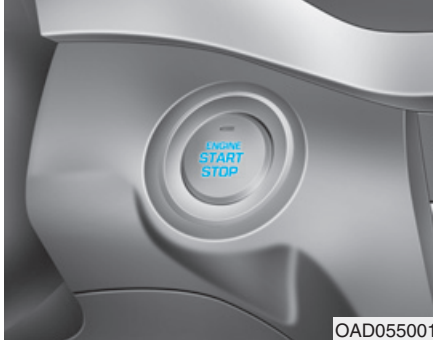

OAD055001

Whenever the front door is opened, the Engine Start/Stop button will illuminate and will go off 30 seconds after the door is closed. (if equipped)

WARNING

To turn the engine off in an emergency:

Press and hold the Engine Start/Stop button for more than two seconds OR rapidly press and release the Engine Start/Stop button three times (within three seconds).



If the vehicle is still moving, you can restart the engine without depressing the brake pedal by pressing the Engine Start/Stop button with the shift lever in the N (Neutral) position.

WARNING



- NEVER press the Engine Start/Stop button while the vehicle is in motion except in an emergency. This will result in the engine turning off and loss of power assist for the steering and brake systems. This may lead to loss of directional control and braking function, which could cause an accident.
- Before leaving the driver's seat, always make sure the shift lever is in the P (Park) position, set the parking brake, press the Engine Start/Stop button to the OFF position, and take the Smart Key with you. Unexpected vehicle movement may occur if these precautions are not followed.

Engine Stop/Start button positions

- Vehicle with manual transmission



Button Position	Action	Notes
<p>OFF</p>  <p>Not illuminated</p>	<p>To turn off the engine, stop the vehicle and then press the Engine Start/Stop button. The steering wheel locks to protect the vehicle from theft. (if equipped)</p>	<p>If the steering wheel is not locked properly when you open the driver's door, the warning chime will sound.</p>
<p>ACC</p>  <p>Orange indicator</p>	<p>Press the Engine Start/Stop button when the button is in the OFF position without depressing the clutch pedal. Electrical accessories are usable. The steering wheel unlocks.</p>	<p>If you leave the Engine Start/Stop button in the ACC position for more than one hour, the battery power will turn off automatically to prevent the battery from discharging. If the steering wheel doesn't unlock properly, the Engine Start/Stop button will not work. Press the Engine Start/Stop button while turning the steering wheel right and left to release tension.</p>

- Vehicle with manual transmission



Button Position	Action	Notes
<p data-bbox="220 255 261 281">ON</p>  <p data-bbox="173 561 308 580">Blue indicator</p>	<p data-bbox="384 262 895 344">Press the Engine Start/Stop button while it is in the ACC position without depressing the clutch pedal.</p> <p data-bbox="384 356 884 407">The warning lights can be checked before the engine is started.</p>	<p data-bbox="935 262 1461 344">Do not leave the Engine Start/Stop button in the ON position when the engine is not running to prevent the battery from discharging.</p>
<p data-bbox="196 598 285 623">START</p>  <p data-bbox="169 900 312 919">Not illuminated</p>	<p data-bbox="384 601 895 684">To start the engine, depress the clutch and brake pedals and press the Engine Start/Stop button with the shift lever in neutral.</p>	<p data-bbox="935 601 1422 713">If you press the Engine Start/Stop button without depressing the clutch pedal, the engine does not start and the Engine Start/Stop button changes as follows: OFF → ACC → ON → OFF or ACC</p>

Engine Stop/Start button positions

- Vehicle with automatic transmission/dual clutch transmission

Button Position	Action	Notes
<p>OFF</p>  <p>Not illuminated</p>	<p>To turn off the engine, press the Engine Start/Stop button with shift lever in P (Park). When you press the Engine Start/Stop button without the shift lever in P (Park), the Engine Start/Stop button does not turn to the OFF position, but turns to the ACC position.</p> <p>The steering wheel locks to protect the vehicle from theft. (if equipped)</p>	<p>If the steering wheel is not locked properly when you open the driver's door, the warning chime will sound.</p>
<p>ACC</p>  <p>Orange indicator</p>	<p>Press the Engine Start/Stop button when the button is in the OFF position without depressing the brake pedal.</p> <p>Electrical accessories are usable.</p> <p>The steering wheel unlocks.</p>	<p>If you leave the Engine Start/Stop button in the ACC position for more than one hour, the battery power will turn off automatically to prevent the battery from discharging.</p> <p>If the steering wheel doesn't unlock properly, the Engine Start/Stop button will not work. Press the Engine Start/Stop button while turning the steering wheel right and left to release tension.</p>

- Vehicle with automatic transmission/dual clutch transmission

Button Position	Action	Notes
<p data-bbox="220 255 261 280">ON</p>  <p data-bbox="173 561 304 580">Blue indicator</p>	<p data-bbox="384 262 895 344">Press the Engine Start/Stop button while it is in the ACC position without depressing the brake pedal.</p> <p data-bbox="384 356 884 407">The warning lights can be checked before the engine is started.</p>	<p data-bbox="935 262 1461 344">Do not leave the Engine Start/Stop button in the ON position when the engine is not running to prevent the battery from discharging.</p>
<p data-bbox="196 598 285 622">START</p>  <p data-bbox="169 897 312 916">Not illuminated</p>	<p data-bbox="384 602 908 712">To start the engine, depress the brake pedal and press the Engine Start/Stop button with the shift lever in the P (Park) or in the N (Neutral) position.</p> <p data-bbox="384 723 863 775">For your safety, start the engine with the shift lever in the P (Park) position.</p>	<p data-bbox="935 602 1422 712">If you press the Engine Start/Stop button without depressing the brake pedal, the engine does not start and the Engine Start/Stop button changes as follows:</p> <p data-bbox="935 723 1366 748">OFF → ACC → ON → OFF or ACC</p>

Starting the engine

WARNING

- Always wear appropriate shoes when operating your vehicle. Unsuitable shoes, such as high heels, ski boots, sandals, flip-flops, etc., may interfere with your ability to use the brake, accelerator and clutch pedals.
- Do not start the vehicle with the accelerator pedal depressed. The vehicle can move and lead to an accident.
- Wait until the engine rpm is normal. The vehicle may suddenly move if the brake pedal is released when the rpm is high.

Information

- The engine will start by pressing the Engine Start/Stop button, only when the smart key is in the vehicle.
- Even if the smart key is in the vehicle, if it is far away from the driver, the engine may not start.
- When the Engine Start/Stop button is in the ACC or ON position, if any door is open, the system checks for the smart key. If the smart key is not in the vehicle, the " " indicator will blink and the warning "Key not in vehicle" will come on, and if all doors are closed, the chime will also sound for about 5 seconds. Keep the smart key in the vehicle when using the ACC position or if the vehicle engine is ON.

Starting the gasoline engine

Vehicle with manual transmission:

1. Always carry the smart key with you.
2. Make sure the parking brake is applied.
3. Make sure the shift lever is in neutral.
4. Depress the clutch and brake pedals.
5. Press the Engine Start/Stop button.

Vehicle with automatic transmission/dual clutch transmission:

1. Always carry the smart key with you.
2. Make sure the parking brake is applied.
3. Make sure the shift lever is in P (Park).
4. Depress the brake pedal.
5. Press the Engine Start/Stop button.



i Information

- It is best to maintain a moderate engine speed until the vehicle engine comes up to normal operating temperature. Avoid harsh or abrupt acceleration or deceleration while the engine is still cold.
- Always start the vehicle with your foot on the brake pedal. Do not depress the accelerator while starting the vehicle. Do not race the engine while warming it up.



Starting the diesel engine

To start the diesel engine when the engine is cold, it has to be pre-heated before starting the engine and then have to be warmed up before starting to drive.

Vehicle with manual transmission:

1. Always carry the smart key with you.
2. Make sure the parking brake is applied.
3. Make sure the shift lever is in neutral.
4. Depress the clutch and brake pedal.
5. Press the Engine Start/Stop button.
6. Continue depressing the brake pedal until the glow indicator light () goes out.
7. When the glow indicator light () goes out, the engine will start.

Vehicle with dual clutch transmission:

1. Always carry the smart key with you.
2. Make sure the parking brake is applied.
3. Make sure the shift lever is in P (Park).
4. Depress the brake pedal.
5. Press the Engine Start/Stop button.
6. Continue depressing the brake pedal until the glow indicator light () goes out.
7. When the glow indicator light () goes out, the engine will start.

NOTICE

If the Engine Start/Stop button is pressed while the engine is pre-heating, the engine may start.

Starting and stopping the engine for turbocharger intercooler

1. Do not race or accelerate the engine immediately after starting the engine.

If the engine is cold, idle for several seconds before sufficient lubrication is ensured in the turbo charger unit.

2. After high speed or extended driving that requires heavy engine load, idle the engine about 1 minute before turning the engine off. This idle time will allow the turbocharger to cool prior to shutting the engine off.

NOTICE

Do not turn off the engine immediately after it has been subjected to a heavy load. Doing so may cause severe damage to the engine or turbo charger unit.

NOTICE

To prevent damage to the vehicle:

- **If the engine stalls while you are in motion, do not attempt to move the shift lever to the P (Park) position.**

If traffic and road conditions permit, you may put the shift lever in the N (Neutral) position while the vehicle is still moving and press the Engine Start/Stop button in an attempt to restart the engine.

- **Do not push or tow your vehicle to start the engine.**

NOTICE

To prevent damage to the vehicle:

Do not press the Engine Start/Stop button for more than 10 seconds except when the stop lamp fuse is blown.

When the stop lamp fuse is blown, you can't start the engine normally. Replace the fuse with a new one. If you are not able to replace the fuse, you can start the engine by pressing and holding the Engine Start/Stop button for 10 seconds with the Engine Start/Stop button in the ACC position.

For your safety always depress the brake and/or clutch pedal before starting the engine.

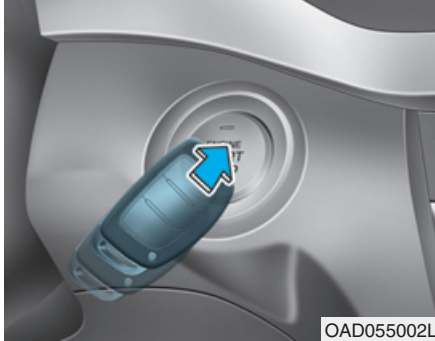

i Information

If the smart key battery is weak or the smart key does not work correctly, you can start the engine by pressing the Engine Start/Stop button with the smart key in the direction of the picture above.

MANUAL TRANSMISSION (IF EQUIPPED)

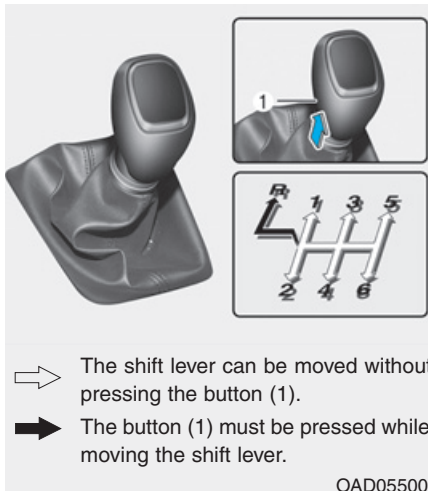

Manual transmission operation

The manual transmission has 6 forward gears. The transmission is fully synchronized in all forward gears so shifting to either a higher or a lower gear is easily accomplished.

⚠ WARNING

Before leaving the driver's seat, always make sure the shift lever is in 1st gear when the vehicle is parked on a uphill and in R (Reverse) on a downhill, set the parking brake, and place the ignition switch in the LOCK/OFF position. Unexpected vehicle movement may occur if these precautions are not followed.

To shift to R (Reverse), make sure the vehicle has completely stopped, and then move the shift lever to neutral before moving into R (Reverse).

When you've come to a complete stop and it's hard to shift into 1st gear or R (Reverse):

1. Put the shift lever in neutral and release the clutch pedal.
2. Depress the clutch pedal, and then shift into first or R (Reverse) gear.

i Information

During cold weather, shifting may be difficult until the transmission lubricant has warmed up.

Using the clutch

The clutch pedal should be depressed all the way before:

- Starting the engine

The engine will not start without depressing the clutch pedal.

- Shifting into gear, up shifting to the next higher gear, or down shifting to the next low gear.

When releasing the clutch pedal, release it slowly. The clutch pedal should always be released while driving.

NOTICE

To prevent unnecessary wear or damage to the clutch:

- **Do not rest your foot on the clutch pedal while driving.**
- **Do not hold the vehicle with the clutch on an incline, while waiting for the traffic light, etc.**
- **Always depress the clutch pedal down fully to prevent noise or damage.**
- **Do not start with the 2nd (second) gear engaged except when you start on a slippery road.**

Downshifting

Down shift to a lower gear when slowing down in heavy traffic or driving up a steep hill to prevent high engine loads.

Also, downshifting reduces the chance of stalling help reaccelerate the vehicle when you need to increase your speed.

When the vehicle is going downhill, downshifting helps maintain safe speed by providing brake power from the engine and results in less wear on the brakes.

NOTICE

To prevent damage to the engine, clutch and transmission:

- **When downshifting from 5th gear to 4th gear, be careful not to inadvertently push the shift lever sideways engaging the 2nd gear. A drastic downshift may cause the engine speed to increase to the point the tachometer will enter the red-zone and may cause engine damage.**
- **Do not downshift more than two gear at a time or downshift the gear when the engine is running at high speed (5,000 RPM or higher). Such downshifting may damage the engine, clutch and the transmission.**

Good driving practices

- Never take the vehicle out of gear and coast down a hill. This is extremely dangerous.
- Don't "ride" the brakes. This can cause the brakes and related parts to overheat and malfunction.

When you are driving down a long hill, slow down and shift to a lower gear. Engine braking will help slow down the vehicle.

- Slow down before shifting to a lower gear. This will help avoid over-revving the engine, which can cause damage.
- Slow down when you encounter cross winds. This gives you much better control of your vehicle.
- Be sure the vehicle is completely stopped before you shift into R (Reverse) to prevent damage to the transmission.

- Exercise extreme caution when driving on a slippery surface. Be especially careful when braking, accelerating or shifting gears. On a slippery surface, an abrupt change in vehicle speed can cause the drive wheels to lose traction and may cause loss of vehicle control resulting in an accident

WARNING

Do not use the engine brake (shifting from a higher gear to lower gear) rapidly on slippery roads. The vehicle may slip causing an accident.

⚠ WARNING

To reduce the risk of **SERIOUS INJURY** or **DEATH**:

- **ALWAYS** wear your seatbelt. In a collision, an unbelted occupant is significantly more likely to be seriously injured or killed than a properly belted occupant.
- Avoid high speeds when cornering or turning.
- Do not make quick steering wheel movements, such as sharp lane changes or fast, sharp turns.
- The risk of rollover is greatly increased if you lose control of your vehicle at highway speeds.
- Loss of control often occurs if two or more wheels drop off the roadway and the driver over steers to reenter the roadway.

(Continued)

(Continued)

- In the event your vehicle leaves the roadway, do not steer sharply. Instead, slow down before pulling back into the travel lanes.
- **HYUNDAI** recommends you follow all posted speed limits.

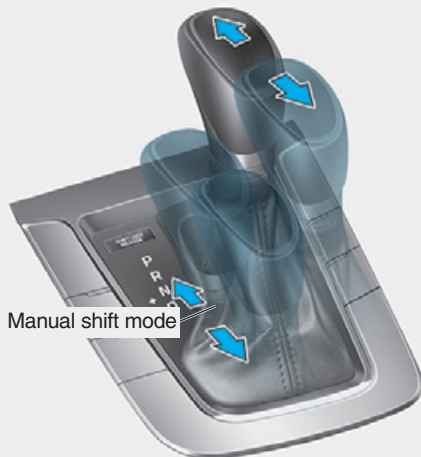
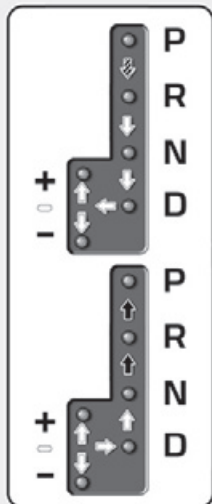

AUTOMATIC TRANSMISSION (IF EQUIPPED)

■ Left-hand drive

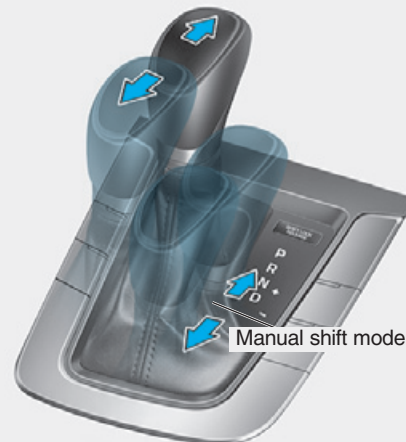
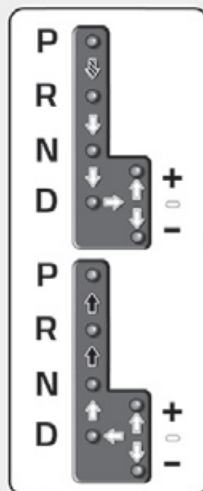

■ Right-hand drive



-  Depress the brake pedal and press the shift button while moving the shift lever.
-  Press the shift button while moving the shift lever.
-  The shift lever can freely operate.

OAD055005/OAD055005R

Automatic transmission operation

The automatic transmission has six forward speeds and one reverse speed. The individual speeds are selected automatically in the D (Drive) position.

WARNING

To reduce the risk of serious injury or death:

- **ALWAYS** check the surrounding areas near your vehicle for people, especially children, before shifting a vehicle into D (Drive) or R (Reverse).
- Before leaving the driver's seat, always make sure the shift lever is in the P (Park) position, then set the parking brake, and place the ignition switch in the LOCK/OFF position. Unexpected and sudden vehicle movement can occur if these precautions are not followed.
- When using Manual Shift Mode, do not use engine braking (shifting from a high gear to lower gear) rapidly on slippery roads. The vehicle may slip causing an accident.

Shift lever position

The indicator in the instrument cluster displays the shift lever position when the ignition switch is in the ON position.

P (Park)

Always come to a complete stop before shifting into P (Park).

To shift from P (Park), you must depress firmly on the brake pedal and make sure your foot is off the accelerator pedal.

If you have done all of the above and still cannot shift the lever out of P (Park), see "Shift-Lock Release" in this chapter.

The shift lever must be in P (Park) before turning the engine off.

WARNING

- **Shifting into P (Park) while the vehicle is in motion may cause you to lose control of the vehicle.**
- **After the vehicle has stopped, always make sure the shift lever is in P (Park), apply the parking brake, and turn the engine off.**
- **Do not use the P (Park) position in place of the parking brake.**

R (Reverse)

Use this position to drive the vehicle backward.

NOTICE

Always come to a complete stop before shifting into or out of R (Reverse); you may damage the transmission if you shift into R (Reverse) while the vehicle is in motion.

N (Neutral)

The wheels and transmission are not engaged.

Use N (Neutral) if you need to restart a stalled engine, or if it is necessary to stop with the engine ON. Shift into P (Park) if you need to leave your vehicle for any reason.

Always depress the brake pedal when you are shifting from N (Neutral) to another gear.

WARNING

Do not shift into gear unless your foot is firmly on the brake pedal. Shifting into gear when the engine is running at high speed can cause the vehicle to move very rapidly. You could lose control of the vehicle and hit people or objects.

D (Drive)

This is the normal driving position. The transmission will automatically shift through a 6-gear sequence, providing the best fuel economy and power.

For extra power when passing another vehicle or driving uphill, depress the accelerator fully. The transmission will automatically downshift to the next lower gear (or gears, as appropriate).

The DRIVE MODE switch, located on the shift lever console, allows the driver to switch from NORMAL mode to ECO or SPORT mode. (if equipped)

For more information, refer to "Drive Mode Integrated Control System" later in this chapter.

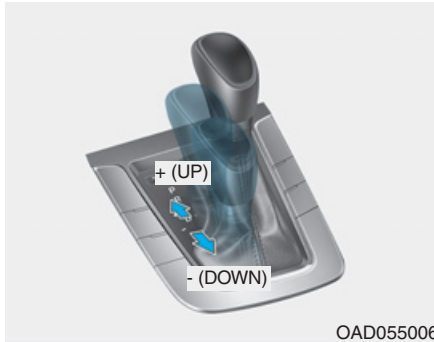

Manual shift mode

Whether the vehicle is stationary or in motion, manual shift mode is selected by pushing the shift lever from the D (Drive) position into the manual gate. To return to D (Drive) range operation, push the shift lever back into the main gate.

In manual shift mode, moving the shift lever backwards and forwards will allow you to select the desired range of gears for the current driving conditions.

- + (Up) : Push the lever forward once to shift up one gear.
- (Down) : Pull the lever backwards once to shift down one gear.

i Information

- Only the six forward gears can be selected. To reverse or park the vehicle, move the shift lever to the R (Reverse) or P (Park) position as required.
- Downshifts are made automatically when the vehicle slows down. When the vehicle stops, 1st gear is automatically selected.
- When the engine rpm approaches the red zone the transmission will upshift automatically.

(Continued)

(Continued)

- If the driver presses the lever to + (Up) or - (Down) position, the transmission may not make the requested gear change if the next gear is outside of the allowable engine rpm range. The driver must execute upshifts in accordance with road conditions, taking care to keep the engine rpms below the red zone.
- When driving on a slippery road, push the shift lever forward into the + (Up) position. This causes the transmission to shift into the 2nd gear which is better for smooth driving on a slippery road. Push the shift lever to the - (Down) side to shift back to the 1st gear.
- When driving in manual shift mode, slow down before shifting to a lower gear. Otherwise, the lower gear may not be engaged if the engine rpms are outside of the allowable range.

Shift-lock system

For your safety, the automatic transmission has a shift-lock system which prevents shifting the transmission from P (Park) into R (Reverse) unless the brake pedal is depressed. To shift the transmission from P (Park) into R (Reverse):

1. Depress and hold the brake pedal.
2. Start the engine or place the ignition switch in the ON position.
3. Move the shift lever.

Shift-lock release

If the shift lever cannot be moved from the P (Park) position into R (Reverse) position with the brake pedal depressed, continue depressing the brake, and then do the following:

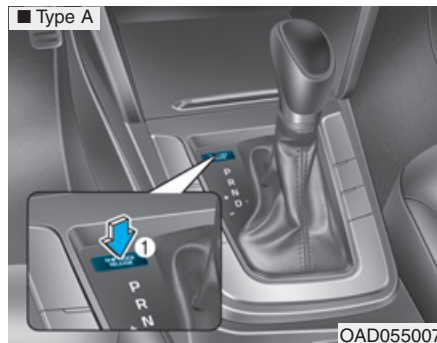

1. Place the ignition switch in the LOCK/OFF position.
2. Apply the parking brake.
3. Push the shift-lock release button.
4. Move the shift lever while pushing the shift-lock release button.
5. Stop pushing the shift-lock release button.
6. Depress the brake pedal, and then restart the engine.

If you need to use the shift-lock release, we recommend that the system be inspected by an authorized HYUNDAI dealer immediately.

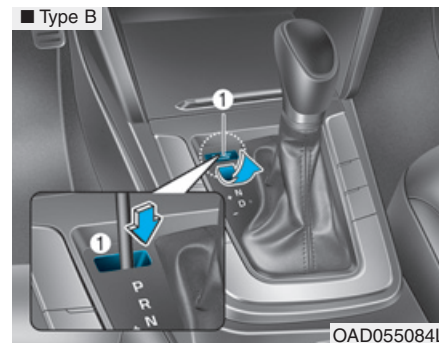

1. Place the ignition switch in the LOCK/OFF position.
2. Apply the parking brake.
3. Carefully remove the cap (1) covering the shift-lock access hole.
4. Insert a tool (e.g. flathead screwdriver) into the access hole and press down on the tool.
5. Move the shift lever while holding down the screwdriver.
6. Remove the tool from the shiftlock release access hole then install the cap.
7. Depress the brake pedal, and then restart the engine.

If you need to use the shift-lock release, we recommend that the system be inspected by an authorized HYUNDAI dealer immediately.

Ignition key interlock system (if equipped)

The ignition key cannot be removed unless the shift lever is in the P (Park) position.

Parking

Always come to a complete stop and continue to depress the brake pedal. Move the shift lever into the P (Park) position, apply the parking brake, and place the ignition switch in the LOCK/OFF position. Take the Key with you when exiting the vehicle.

WARNING

When you stay in the vehicle with the engine running, be careful not to depress the accelerator pedal for a long period of time. The engine or exhaust system may overheat and start a fire.

The exhaust gas and the exhaust system are very hot. Keep away from the exhaust system components.

Do not stop or park over flammable materials, such as dry grass, paper or leaves. They may ignite and cause a fire.

Good driving practices

- Never move the shift lever from P (Park) or N (Neutral) to any other position with the accelerator pedal depressed.
- Never move the shift lever into P (Park) when the vehicle is in motion.

Be sure the vehicle is completely stopped before you attempt to shift into R (Reverse) or D (Drive).

- Do not move the shift lever to N (Neutral) when driving. Doing so may result in an accident because of a loss of engine braking and the transmission could be damaged.
- Do not drive with your foot resting on the brake pedal. Even light, but consistent pedal pressure can result in the brakes overheating, brake wear and possibly even brake failure.

- Always apply the parking brake when leaving the vehicle. Do not depend on placing the transmission in P (Park) to keep the vehicle from moving.
- Exercise extreme caution when driving on a slippery surface. Be especially careful when braking, accelerating or shifting gears. On a slippery surface, an abrupt change in vehicle speed can cause the drive wheels to lose traction and may cause loss of vehicle control resulting in an accident
- Optimum vehicle performance and economy is obtained by smoothly depressing and releasing the accelerator.

WARNING

To reduce the risk of SERIOUS INJURY or DEATH:

- **ALWAYS wear your seatbelt. In a collision, an unbelted occupant is significantly more likely to be seriously injured or killed than a properly belted occupant.**
- **Avoid high speeds when cornering or turning.**
- **Do not make quick steering wheel movements, such as sharp lane changes or fast, sharp turns.**
- **The risk of rollover is greatly increased if you lose control of your vehicle at highway speeds.**
- **Loss of control often occurs if two or more wheels drop off the roadway and the driver over steers to reenter the roadway.**

(Continued)

(Continued)

- **In the event your vehicle leaves the roadway, do not steer sharply. Instead, slow down before pulling back into the travel lanes.**
- **HYUNDAI recommends you follow all posted speed limits.**

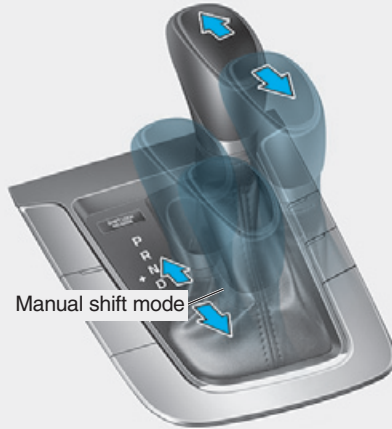
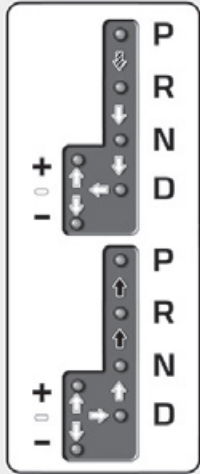

DUAL CLUTCH TRANSMISSION (IF EQUIPPED)

■ Left-hand drive

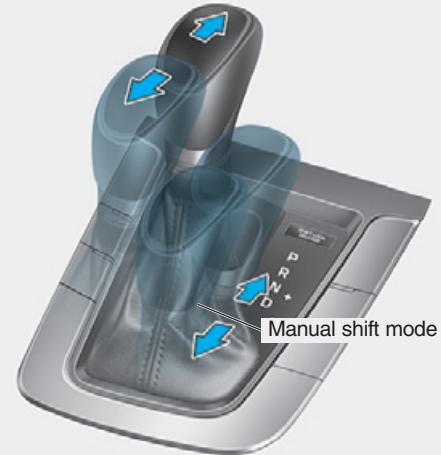
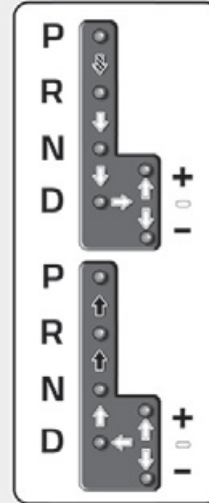

■ Right-hand drive



-  Depress the brake pedal and press the shift button while moving the shift lever.
-  Press the shift button while moving the shift lever.
-  The shift lever can freely operate.

OAD055005/OAD055005R

Dual clutch transmission operation

The dual clutch transmission has seven forward speeds and one reverse speed. The individual speeds are selected automatically in the D (Drive) position.

⚠ WARNING

To reduce the risk of serious injury or death:

- **ALWAYS** check the surrounding areas near your vehicle for people, especially children, before shifting a vehicle into D (Drive) or R (Reverse).
- **Before leaving the driver's seat, always make sure the shift lever is in the P (Park) position, then set the parking brake, and place the ignition switch in the LOCK/OFF position. Unexpected and sudden vehicle movement can occur if these precautions are not followed.**

(Continued)

(Continued)

- **Do not use the engine brake (shifting from a high gear to lower gear) rapidly on slippery roads. The vehicle may slip causing an accident.**

- The dual clutch transmission gives the driving feel of a manual transmission, yet provides the ease of a fully automatic transmission. Unlike a traditional automatic transmission, the gear shifting can sometimes be felt and heard on the dual clutch transmission, as the actuators engage the clutch and the gear is selected.

The dual clutch transmission can be thought of as an automatically shifting manual transmission. When D (Drive) is selected, the transmission will automatically shift through the gears similar to a conventional automatic transmission.

- The dual clutch transmission incorporates a dry-type dual clutch mechanism, which allows for better acceleration performance and increased fuel efficiency while driving. But it differs from a conventional automatic transmission in that it does not incorporate a torque converter. Instead, the transition from one gear to the next is managed by clutch slip, especially at lower speeds. As a result, shifts are sometimes more noticeable, and a light vibration can be felt as the transmission shaft speed is matched with the engine shaft speed. This is a normal condition of the dual clutch transmission.
- The dry-type clutch transfers torque more directly and provides a direct-drive feeling which may feel different from a conventional automatic transmission. This may be more noticeable when launching the vehicle from a stop or when traveling at low, stop-and-go vehicle speeds.

- When rapidly accelerating from a lower vehicle speed, the engine rpm may increase dramatically as a result of clutch slip as the dual clutch transmission selects the correct gear. This is a normal condition.
- When accelerating from a stop on an incline, press the accelerator smoothly and gradually to avoid any shudder feeling or jerkiness.
- When traveling at a lower vehicle speed, if you release the accelerator pedal quickly, you may feel engine braking before the transmission changes gears. This engine braking feeling is similar to operating a manual transmission at low speed.
- When driving downhill, you may wish to move the gear shift lever to Manual Shift mode and downshift to a lower gear in order to control your speed without using the brake pedal excessively.
- When you turn the engine on and off, you may hear clicking sounds as the system goes through a self test. This is a normal sound for the dual clutch transmission.

NOTICE

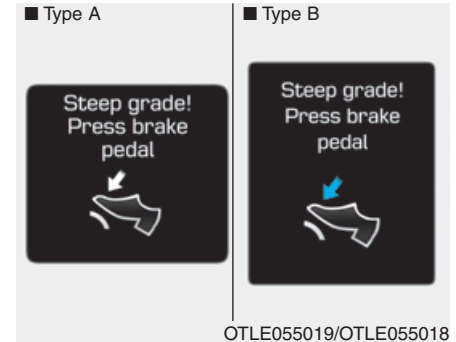

- **To hold the vehicle on a hill use the foot brake or the parking brake. If the vehicle is held by applying the accelerator pedal on a hill the clutch and transmission will be overheated resulting in damage.**

At this time, a warning message will appear on the LCD display and you may feel a vibration.

(Continued)

(Continued)

- If the clutch becomes overheated by excessive use of the clutch to hold on a hill, you may notice a shudder feeling and a blinking display on the instrument cluster. When this occurs, the clutch is disabled until the clutch cools to normal temperatures. If this occurs, pull over to a safe location, shift into P (Park) and apply the foot brake for a few minutes.
- If the LCD warning is active, the foot brake must be applied.
- Ignoring the warnings can lead to damage to the transmission.
- If the display continues to blink, for your safety, we recommend that you contact an authorized HYUNDAI dealer and have the system checked.

(Continued)

(Continued)

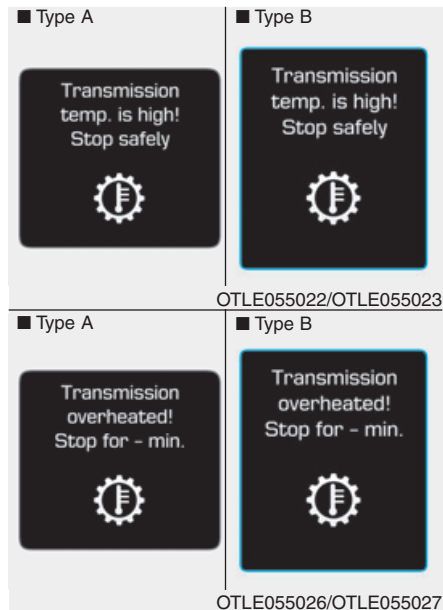

- Under certain conditions, such as repeated stop-and-go launches on steep grades, the transmission clutches may overheat. When the clutches are overheated, the transmission safe protection mode logic is enabled.

(Continued)

(Continued)

If the safe protection mode logic is enabled, the gear position indicator on the cluster blinks with a chime sound. At this time, a warning message will appear on the LCD display and driving may not be smooth.

If you ignore this warning, the driving condition may become worse. To return the normal driving condition, stop the vehicle and apply the foot brake for a few minutes before driving off.

- Gear shifts may be more noticeable than a conventional automatic transmission. This is a normal characteristic of this type of dual clutch transmission.

(Continued)

(Continued)

- During the first 1,500 km (1,000 miles), you may feel that the vehicle may not be smooth when accelerating at low speed. During this break-in period, the shift quality and performance of your new vehicle is continuously optimized.
- Always come to a complete stop before shifting into D (Drive) or R (Reverse).
- Do not put the shift lever in N (Neutral) while driving.

Shift lever position

The indicator in the instrument cluster displays the shift lever position when the ignition switch is in the ON position.

P (Park)

Always come to a complete stop before shifting into P (Park).

To shift from P (Park), you must depress firmly on the brake pedal and make sure your foot is off the accelerator pedal.

If you have done all of the above and still cannot shift the lever out of P (Park), see "Shift-Lock Release" in this chapter.

The shift lever must be in P (Park) before turning the engine off.

WARNING

- Shifting into P (Park) while the vehicle is in motion may cause you to lose control of the vehicle.
- After the vehicle has stopped, always make sure the shift lever is in P (Park), apply the parking brake, and turn the engine off.
- Do not use the P (Park) position in place of the parking brake.

R (Reverse)

Use this position to drive the vehicle backward.

NOTICE

Always come to a complete stop before shifting into or out of R (Reverse); you may damage the transmission if you shift into R (Reverse) while the vehicle is in motion.

N (Neutral)

The wheels and transmission are not engaged.

Use N (Neutral) if you need to restart a stalled engine, or if it is necessary to stop with the engine ON. Shift into P (Park) if you need to leave your vehicle for any reason.

Always depress the brake pedal when you are shifting from N (Neutral) to another gear.

D (Drive)

This is the normal driving position. The transmission will automatically shift through a 7-gear sequence, providing the best fuel economy and power.

For extra power when passing another vehicle or driving uphill, depress the accelerator fully. The transmission will automatically downshift to the next lower gear (or gears, as appropriate).

The DRIVE MODE switch, located on the shift lever console, allows the driver to switch from NORMAL mode to ECO or SPORT mode. (if equipped)

For more information, refer to "Drive Mode Integrated Control System" later in this chapter.

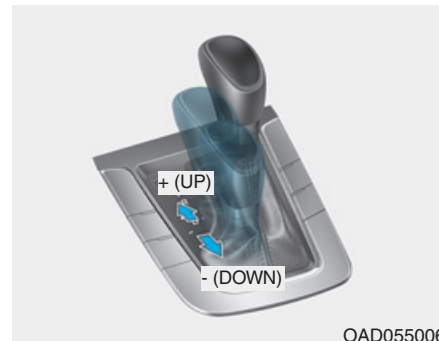

OAD055006

Manual shift mode

Whether the vehicle is stationary or in motion, manual shift mode is selected by pushing the shift lever from the D (Drive) position into the manual gate. To return to D (Drive) range operation, push the shift lever back into the main gate.

In manual shift mode, moving the shift lever backwards and forwards will allow you to make gearshifts rapidly.

Up (+) : Push the lever forward once to shift up one gear.

Down (-) : Pull the lever backwards once to shift down one gear.

i Information

- Only the seven forward gears can be selected. To reverse or park the vehicle, move the shift lever to the R (Reverse) or P (Park) position as required.
- Downshifts are made automatically when the vehicle slows down. When the vehicle stops, 1st gear is automatically selected.
- When the engine rpm approaches the red zone the transmission will upshift automatically.
- If the driver presses the lever to + (Up) or - (Down) position, the transmission may not make the requested gear change if the next gear is outside of the allowable engine rpm range. The driver must execute upshifts in accordance with road conditions, taking care to keep the engine rpms below the red zone.

(Continued)

(Continued)

- When driving on a slippery road, push the shift lever forward into the + (Up) position. This causes the transmission to shift into the 2nd gear which is better for smooth driving on a slippery road. Push the shift lever to the - (Down) side to shift back to the 1st gear.
- When driving in manual shift mode, slow down before shifting to a lower gear. Otherwise, the lower gear may not be engaged if the engine rpms are outside of the allowable range.

Shift-lock system

For your safety, the dual clutch transmission has a shift-lock system which prevents shifting the transmission from P (Park) into R (Reverse) unless the brake pedal is depressed.

To shift the transmission from P (Park) into R (Reverse):

1. Depress and hold the brake pedal.
2. Start the engine or place the ignition switch in the ON position.
3. Move the shift lever.

Shift-lock release

If the shift lever cannot be moved from the P (Park) position into R (Reverse) position with the brake pedal depressed, continue depressing the brake, and then do the following:

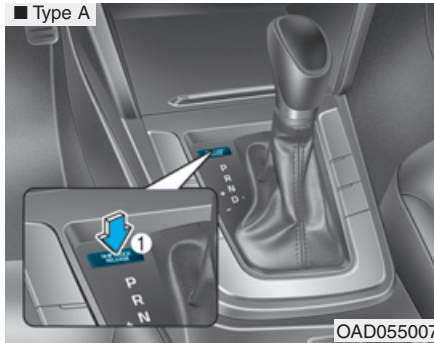

1. Place the ignition switch in the LOCK/OFF position.
2. Apply the parking brake.
3. Push the shift-lock release button.
4. Move the shift lever while pushing the shift-lock release button.
5. Stop pushing the shift-lock release button.
6. Depress the brake pedal, and then restart the engine.

If you need to use the shift-lock release, we recommend that the system be inspected by an authorized HYUNDAI dealer immediately.

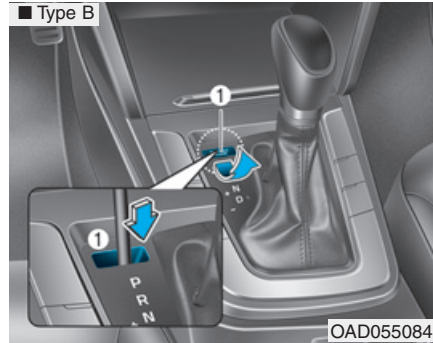

1. Place the ignition switch in the LOCK/OFF position.
2. Apply the parking brake.
3. Carefully remove the cap (1) covering the shift-lock access hole.
4. Insert a tool (e.g. flathead screwdriver) into the access hole and press down on the tool.
5. Move the shift lever while holding down the screwdriver.
6. Remove the tool from the shiftlock release access hole then install the cap.
7. Depress the brake pedal, and then restart the engine.

If you need to use the shift-lock release, we recommend that the system be inspected by an authorized HYUNDAI dealer immediately.

Ignition key interlock system (if equipped)

The ignition key cannot be removed unless the shift lever is in the P (Park) position.

Parking

Always come to a complete stop and continue to depress the brake pedal. Move the shift lever into the P (Park) position, apply the parking brake, and place the ignition switch in the LOCK/OFF position. Take the Key with you when exiting the vehicle.

WARNING

When you stay in the vehicle with the engine running, be careful not to depress the accelerator pedal for a long period of time. The engine or exhaust system may overheat and start a fire.

The exhaust gas and the exhaust system are very hot. Keep away from the exhaust system components.

Do not stop or park over flammable materials, such as dry grass, paper or leaves. They may ignite and cause a fire.

Good driving practices

- Never move the shift lever from P (Park) or N (Neutral) to any other position with the accelerator pedal depressed.
- Never move the shift lever into P (Park) when the vehicle is in motion.

Be sure the vehicle is completely stopped before you attempt to shift into R (Reverse) or D (Drive).

- Do not move the shift lever to N (Neutral) when driving. Doing so may result in an accident because of a loss of engine braking and the transmission could be damaged.
- Do not drive with your foot resting on the brake pedal. Even light, but consistent pedal pressure can result in the brakes overheating, brake wear and possibly even brake failure.
- Always apply the parking brake when leaving the vehicle. Do not depend on placing the transmission in P (Park) to keep the vehicle from moving.

- Exercise extreme caution when driving on a slippery surface. Be especially careful when braking, accelerating or shifting gears. On a slippery surface, an abrupt change in vehicle speed can cause the drive wheels to lose traction and may cause loss of vehicle control resulting in an accident
- Optimum vehicle performance and economy is obtained by smoothly depressing and releasing the accelerator.

 **WARNING**

To reduce the risk of **SERIOUS INJURY** or **DEATH**:

- **ALWAYS** wear your seatbelt. In a collision, an unbelted occupant is significantly more likely to be seriously injured or killed than a properly belted occupant.
- Avoid high speeds when cornering or turning.
- Do not make quick steering wheel movements, such as sharp lane changes or fast, sharp turns.
- The risk of rollover is greatly increased if you lose control of your vehicle at highway speeds.
- Loss of control often occurs if two or more wheels drop off the roadway and the driver over steers to reenter the roadway.

(Continued)

(Continued)

- In the event your vehicle leaves the roadway, do not steer sharply. Instead, slow down before pulling back into the travel lanes.
- **HYUNDAI** recommends you follow all posted speed limits.

BRAKING SYSTEM

Power brakes

Your vehicle has power-assisted brakes that adjust automatically through normal usage.

If the engine is not running or is turned off while driving, the power assist for the brakes will not work. You can still stop your vehicle by applying greater force to the brake pedal than typical. The stopping distance, however, will be longer than with power brakes.

When the engine is not running, the reserve brake power is partially depleted each time the brake pedal is applied. Do not pump the brake pedal when the power assist has been interrupted.

Pump the brake pedal only when necessary to maintain steering control on slippery surfaces.

WARNING

Take the following precautions:

- **Do not drive with your foot resting on the brake pedal. This will create abnormal high brake temperatures, excessive brake lining and pad wear, and increased stopping distances.**
- **When descending down a long or steep hill, move the shift lever to Manual Shift mode and manually downshift to a lower gear in order to control your speed without using the brake pedal excessively. Applying the brakes continuously will cause the brakes to overheat and could result in a temporary loss of braking performance.**

(Continued)

(Continued)

- **Wet brakes may impair the vehicle's ability to safely slow down; the vehicle may also pull to one side when the brakes are applied. Applying the brakes lightly will indicate whether they have been affected in this way. Always test your brakes in this fashion after driving through deep water. To dry the brakes, lightly tap the brake pedal to heat up the brakes while maintaining a safe forward speed until brake performance returns to normal. Avoid driving at high speeds until the brakes function correctly.**

Disc brakes wear indicator

When your brake pads are worn and new pads are required, you will hear a high pitched warning sound from your front or rear brakes. You may hear this sound come and go or it may occur whenever you depress the brake pedal.

Note that some driving conditions or climates may cause a brake squeal when you first apply (or lightly apply) the brakes. This is normal and does not indicate a problem with your brakes.

NOTICE

To avoid costly brake repairs, do not continue to drive with worn brake pads.

i Information

Always replace brake pads as complete front or rear axle sets.

Rear drum brakes (if equipped)

Your rear drum brakes do not have wear indicators. Therefore, have the rear brake linings inspected if you hear a rear brake rubbing noise. Also have your rear brakes inspected each time you change or rotate your tires and when you have the front brakes replaced.

Parking brake

Applying the parking brake

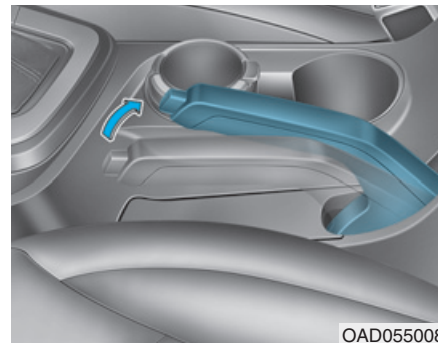

Always set the parking brake before leaving the vehicle, to apply: Firmly depress the brake pedal. Pull up the parking brake lever as far as possible.

⚠ WARNING

To reduce the risk of **SERIOUS INJURY** or **DEATH**, do not operate the parking brake while the vehicle is moving except in an emergency situation. It could damage the brake system and lead to an accident.

Releasing the parking brake

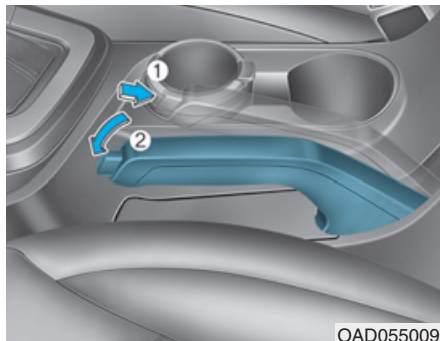

To release:

Firmly depress the brake pedal.

While pressing the release button (1), slightly pull up on the parking brake lever then lower the parking brake lever (2).

⚠ WARNING

- Whenever leaving the vehicle or parking, always come to a complete stop and continue to depress the brake pedal. Move the shift lever into the 1st gear (for manual transmission vehicle) or P (Park, for automatic transmission/dual clutch transmission vehicle) position, then apply the parking brake, and place the ignition switch in the LOCK/OFF position.

Vehicles with the parking brake not fully engaged are at risk for moving inadvertently and causing injury to yourself or others.

- **NEVER** allow anyone who is unfamiliar with the vehicle to touch the parking brake. If the parking brake is released unintentionally, serious injury may occur.
- Only release the parking brake when you are seated inside the vehicle with your foot firmly on the brake pedal.

NOTICE

- **Do not apply the accelerator pedal while the parking brake is engaged. If you depress the accelerator pedal with the parking brake engaged, warning will sound. Damage to the parking brake may occur.**
- **Driving with the parking brake on can overheat the braking system and cause premature wear or damage to brake parts. Make sure the parking brake is released and the Brake Warning Light is off before driving.**



Check the Parking Brake Warning Light by placing the ignition switch to the ON position (do not start the engine).

This light will be illuminated when the parking brake is applied with the ignition switch in the START or ON position.

Before driving, be sure the parking brake is released and the Brake Warning Light is OFF.

If the Parking Brake Warning Light remains on after the parking brake is released while engine is running, there may be a malfunction in the brake system. Immediate attention is necessary.

If at all possible, cease driving the vehicle immediately. If that is not possible, use extreme caution while operating the vehicle and only continue to drive the vehicle until you can reach a safe location.

Anti-lock Brake System (ABS)

WARNING

An Anti-Lock Braking System (ABS) or an Electronic Stability Control (ESC) system will not prevent accidents due to improper or dangerous driving maneuvers. Even though vehicle control is improved during emergency braking, always maintain a safe distance between you and objects ahead of you. Vehicle speeds should always be reduced during extreme road conditions. The braking distance for cars equipped with ABS or ESC may be longer than for those without these systems in the following road conditions.

Drive your vehicle at reduced speeds during the following conditions:

- Rough, gravel or snow-covered roads.

(Continued)

(Continued)

- On roads where the road surface is pitted or has different surface height.
- Tire chains are installed on your vehicle.

The safety features of an ABS or ESC equipped vehicle should not be tested by high speed driving or cornering. This could endanger the safety of yourself or others.

ABS is an electronic braking system that helps prevent a braking skid. ABS allows the driver to steer and brake at the same time.

Using ABS

To obtain the maximum benefit from your ABS in an emergency situation, do not attempt to modulate your brake pressure and do not try to pump your brakes. Depress your brake pedal as hard as possible.

When you apply your brakes under conditions which may lock the wheels, you may hear sounds from the brakes, or feel a corresponding sensation in the brake pedal. This is normal and it means your ABS is active.

ABS does not reduce the time or distance it takes to stop the vehicle.

Always maintain a safe distance from the vehicle in front of you.

ABS will not prevent a skid that results from sudden changes in direction, such as trying to take a corner too fast or making a sudden lane change. Always drive at a safe speed for the road and weather conditions.

ABS cannot prevent a loss of stability. Always steer moderately when braking hard. Severe or sharp steering wheel movement can still cause your vehicle to veer into oncoming traffic or off the road.

On loose or uneven road surfaces, operation of the anti-lock brake system may result in a longer stopping distance than for vehicles equipped with a conventional brake system.

The ABS warning light () will stay on for several seconds after the Engine Start/Stop button is in the ON position. During that time, the ABS will go through self-diagnosis and the light will go off if everything is normal. If the light stays on, you may have a problem with your ABS. We recommend that you contact an authorized HYUNDAI dealer as soon as possible.

WARNING

If the ABS warning light () is on and stays on, you may have a problem with the ABS. Your power brakes will work normally. To reduce the risk of serious injury or death, we recommend that you contact your HYUNDAI dealer as soon as possible.

NOTICE

When you drive on a road having poor traction, such as an icy road, and apply your brakes continuously, the ABS will be active continuously and the ABS warning light () may illuminate. Pull your car over to a safe place and turn the engine off.

Restart the engine. If the ABS warning light is off, then your ABS system is normal.

Otherwise, you may have a problem with your ABS system. We recommend that you contact an authorized HYUNDAI dealer as soon as possible.

Information

When you jump start your vehicle because of a drained battery, the ABS warning light () may turn on at the same time. This happens because of the low battery voltage. It does not mean your ABS is malfunctioning. Have the battery recharged before driving the vehicle.

Electronic Stability Control (ESC) (if equipped)

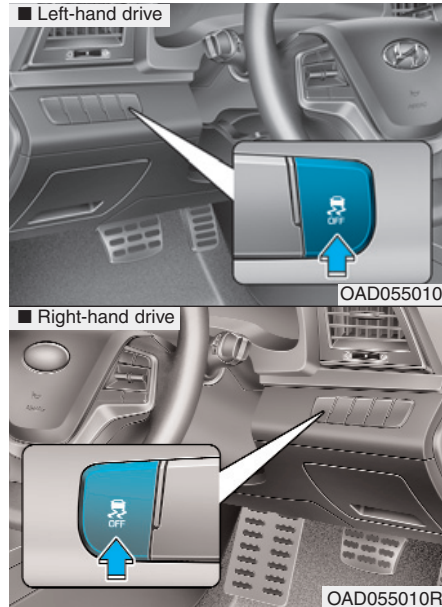

The Electronic Stability Control (ESC) system helps to stabilize the vehicle during cornering maneuvers.

ESC checks where you are steering and where the vehicle is actually going. ESC applies braking pressure to any one of the vehicle's brakes and intervenes in the engine management system to assist the driver with keeping the vehicle on the intended path. It is not a substitute for safe driving practices. Always adjust your speed and driving to the road conditions.

WARNING

Never drive too fast for the road conditions or too quickly when cornering. The ESC system will not prevent accidents.

Excessive speed in turns, abrupt maneuvers, and hydroplaning on wet surfaces can result in severe accidents.

ESC operation

ESC ON condition

When the ignition switch is in the ON position, the ESC and the ESC OFF indicator lights illuminate for approximately three seconds. After both lights go off, the ESC is enabled.

When operating



When the ESC is in operation, the ESC indicator light blinks:

- When you apply your brakes under conditions which may lock the wheels, you may hear sounds from the brakes, or feel a corresponding sensation in the brake pedal. This is normal and it means your ESC is active.
- When the ESC activates, the engine may not respond to the accelerator as it does under routine conditions.
- If the Cruise Control was in use when the ESC activates, the Cruise Control automatically disengages. The Cruise Control can be reengaged when the road conditions allow. **See "Cruise Control System" later in this chapter.** (if equipped)
- When moving out of the mud or driving on a slippery road, the engine rpm (revolutions per minute) may not increase even if you press the accelerator pedal deeply. This is to maintain the stability and traction of the vehicle and does not indicate a problem.

ESC OFF condition



To cancel ESC operation :

• State 1

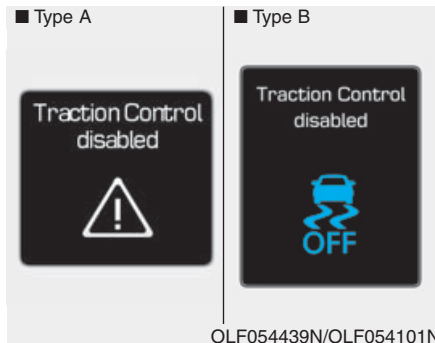

Press the ESC OFF button briefly. The ESC OFF indicator light and message (vehicles equipped with a supervision cluster) will illuminate. In this state, the traction control function of ESC (engine management) is disabled, but the brake control function of ESC (braking management) still operates.

• State 2

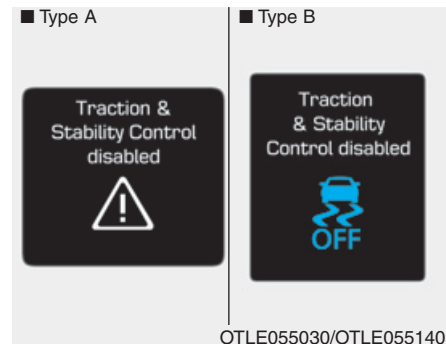

Press and hold the ESC OFF button continuously for more than 3 seconds. The ESC OFF indicator light and message (vehicles equipped with a supervision cluster) illuminates and a warning chime sounds. In this state, both the traction control function of ESC (engine management) and the brake control function of ESC (braking management) are disabled.

If the ignition switch is placed to the LOCK/OFF position when ESC is off, ESC remains off. Upon restarting the engine, the ESC will automatically turn on again.

Indicator lights

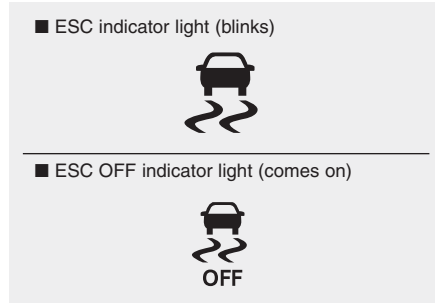

When the ignition switch is pressed to the ON position, the ESC indicator light illuminates, then goes off if the ESC system is operating normally.

The ESC indicator light blinks whenever the ESC is operating.

If the ESC indicator light stays on, your vehicle may have a malfunction with the ESC system. When this warning light illuminates, we recommend that the vehicle be checked by an authorized HYUNDAI dealer as soon as possible.

The ESC OFF indicator light comes on when the ESC is turned off with the button.

WARNING

When the ESC is blinking, this indicates the ESC is active:

Drive slowly and NEVER attempt to accelerate. NEVER turn the ESC off while the ESC indicator light is blinking or you may lose control of the vehicle resulting in an accident.

NOTICE

Driving with wheels and tires with different sizes may cause the ESC system to malfunction. Before replacing tires, make sure all four tires and wheels are the same size. Never drive the vehicle with different sized wheels and tires installed.

ESC OFF usage

When Driving

The ESC OFF mode should only be used briefly to help free the vehicle if stuck in snow or mud by temporarily stopping operation of the ESC to maintain wheel torque.

To turn ESC off while driving, press the ESC OFF button while driving on a flat road surface.

NOTICE

To prevent damage to the transmission:

- **Do not allow wheel(s) of one axle to spin excessively while the ESC, ABS, and parking brake warning lights are displayed. The repairs would not be covered by the vehicle warranty. Reduce engine power and do not spin the wheel(s) excessively while these lights are displayed.**
- **When operating the vehicle on a dynamometer, make sure the ESC is turned off (ESC OFF light illuminated).**

Information

Turning the ESC off does not affect ABS or standard brake system operation.

Vehicle Stability Management (VSM) (if equipped)

The Vehicle Stability Management (VSM) is a function of the Electronic Stability Control (ESC) system. It helps ensure the vehicle stays stable when accelerating or braking suddenly on wet, slippery and rough roads where traction over the four tires can suddenly become uneven.

WARNING

Take the following precautions when using the Vehicle Stability Management (VSM):

- **ALWAYS check the speed and the distance to the vehicle ahead. The VSM is not a substitute for safe driving practices.**
- **Never drive too fast for the road conditions. The VSM system will not prevent accidents. Excessive speed in bad weather, slippery and uneven roads can result in severe accidents.**

VSM operation

VSM ON condition

The VSM operates when:

- The Electronic Stability Control (ESC) is on.
- Vehicle speed is approximately above 15 km/h (9 mph) on curve roads.
- Vehicle speed is approximately above 20 km/h (12 mph) when the vehicle is braking on rough roads.

When operating

When you apply your brakes under conditions which may activate the ESC, you may hear sounds from the brakes, or feel a corresponding sensation in the brake pedal. This is normal and it means your VSM is active.

i Information

The VSM does not operate when:



- Driving on a banked road such as gradient or incline
- Driving rearward.
- ESC OFF indicator light is on.
- EPS (Electric Power Steering) warning light () is on.

VSM OFF condition

To cancel VSM operation, press the ESC OFF button. ESC OFF indicator light () will illuminate.

To turn on VSM, press the ESC OFF button again. The ESC OFF indicator light will go out.

WARNING

If ESC indicator light () or EPS warning light () stays on, your vehicle may have a malfunction with the VSM system. When the warning light illuminates we recommend that the vehicle be checked by an authorized HYUNDAI dealer as soon as possible.

NOTICE

Driving with wheels and tires with different sizes may cause the ESC system to malfunction. Before replacing tires, make sure all four tires and wheels are the same size. Never drive the vehicle with different sized tires and wheels installed.

Hill-Start Assist Control (HAC) (if equipped)

helps prevent has the tendency to slide backwards on a steep slope, before depressing the accelerator after a stop. The HAC prevents the vehicle from sliding backwards and releases the brake after 2 seconds or when the accelerator pedal is depressed.

WARNING

The HAC is activated only for about 2 seconds, so always depress the accelerator pedal to begin driving upwards after a stop.

Information

- **The HAC does not operate when the shift lever is in P (Park) or N (Neutral).**
- **The HAC activates even when the ESC (Electronic Stability Control) is off. However, it does not activate, when the ESC does not normally operate.**

Emergency Stop Signal (ESS) (if equipped)

The Emergency Stop Signal system alerts the driver behind by blinking the stop lights, while sharply and severely braking.

The system is activated when:

- The vehicle suddenly stops. (The deceleration power exceeds 7 m/s^2 , and the driving speed exceeds 55 km/h (34 mph).)
- The ABS is activated.

The hazard warning flasher automatically turns ON after blinking the stop lights, when the driving speeds is decelerated under 40 km/h (25 mph), when the ABS is deactivated, and when the sudden braking situation is over.

The hazard warning flasher turns OFF, when the driving speed exceeds 10 km/h (6 mph) after a complete stop. The hazard warning flasher turns OFF, when the vehicle drives at a low speed for a certain period of time. The driver can manually turn OFF the hazard warning flasher by pressing the button.

i Information

The Emergency Stop Signal (ESS) system will not work if the hazard warning flasher already blinks.

Good braking practices

⚠ WARNING

Whenever leaving the vehicle or parking, always come to a complete stop and continue to depress the brake pedal. Move the shift lever into the P (Park) position, then apply the parking brake, and place the Engine Start/Stop button in the OFF position.

Vehicles parked with the parking brake not applied or not fully engaged may roll inadvertently and may cause injury to the driver and others. ALWAYS apply the parking brake before exiting the vehicle.

Wet brakes can be dangerous! The brakes may get wet if the vehicle is driven through standing water or if it is washed. Your vehicle will not stop as quickly if the brakes are wet. Wet brakes may cause the vehicle to pull to one side.

To dry the brakes, apply the brakes lightly until the braking action returns to normal, taking care to keep the vehicle under control at all times. If the braking action does not return to normal, stop as soon as it is safe to do so and we recommend that you call an authorized HYUNDAI dealer for assistance.

DO NOT drive with your foot resting on the brake pedal. Even light, but constant pedal pressure can result in the brakes overheating, brake wear, and possibly even brake failure.

If a tire goes flat while you are driving, apply the brakes gently and keep the vehicle pointed straight ahead while you slow down. When you are moving slowly enough for it to be safe to do so, pull off the road and stop in a safe location.

Keep your foot firmly on the brake pedal when the vehicle is stopped to prevent the vehicle from rolling forward.

ISG (IDLE STOP AND GO) SYSTEM (IF EQUIPPED)

The ISG system is to reduce the fuel consumption by automatically shutting down the engine, when the vehicle is at a standstill (i.e. red stop light, stop sign, and traffic jam).

The engine is automatically started upon satisfying the starting conditions.

The ISG system is always active, when the engine is running.

i Information

When the engine is automatically started by the ISG system, some warning lights (i.e. ABS, ESC, ESC OFF, EPS, and parking brake warning light) may illuminate for a few seconds due to the low battery voltage. However, it does not indicate a malfunction with the ISG system.

To activate the ISG system

Auto stop



To stop the engine in idle stop mode

1. Decrease the vehicle speed to 0km/h.
2. Shift to D (Drive) or N (Neutral).
3. Press the brake pedal.

The auto stop indicator ((A)) illuminates in green on the instrument cluster, when the engine stops.

i Information

The driving speed must reach at least 8 km/h after an idle stop.

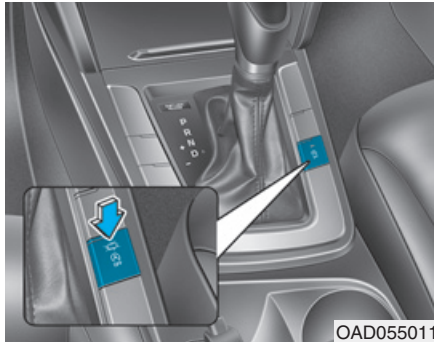

OAD055011

When the driver unfastens the seatbelt or open the driver's door (or the hood) in the auto stop mode, you will experience the followings.

- The ISG system is deactivated. (The ISG OFF button indicator illuminates.)

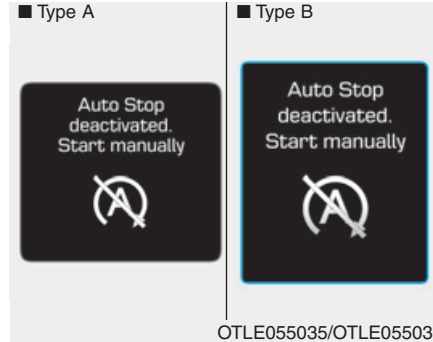

OTLE055035/OTLE055036

- If equipped with a supervision cluster the message, 'Auto Stop deactivated. Start manually', appears on the LCD display.

Auto start

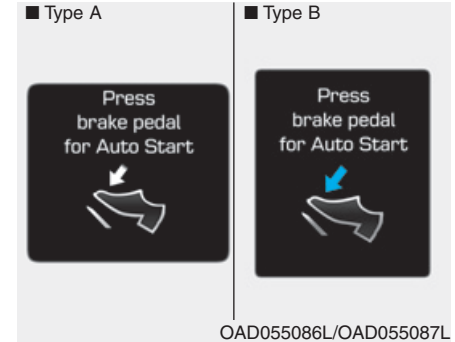

OAD055086L/OAD055087L

To restart the engine in the auto stop mode

- Release the brake pedal.
- If equipped with a supervision cluster the message, "Press brake pedal for Auto Start", appears on the LCD display.
- The auto stop indicator ((A)) goes OFF on the instrument cluster, when the engine is restarted.

The engine is automatically restarted in the following situations.

- The fan speed of the manual climate control system is set above the 3rd position, with the air condition ON.
- The fan speed of the automatic climate control system is set above the 6th position, with the air condition ON.
- A certain period of time has been elapsed with the air condition ON.
- The defroster is activated.
- The brake vacuum pressure is low.
- The battery is weak.
- The driving speed exceeds 2 km/h.

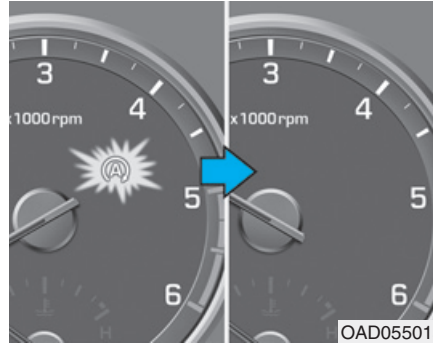

The auto stop indicator ((A)) blinks in green for 5 seconds on the instrument cluster,

Prerequisite for activation

The ISG system operates in the following situations.

- The driver's seatbelt is fastened.
- The driver's door and the hood are closed.
- The brake vacuum pressure is adequate.
- The battery is sufficiently charged.
- The outside temperature is between -2 °C and 35 °C (28.4 °F and 95 °F).
- The engine coolant temperature is not too low.

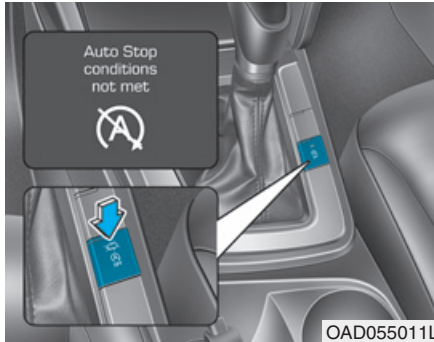

i Information

- The ISG system is not activated, when the prerequisites to activate the ISG system are unsatisfied. In this case, the ISG OFF button indicator illuminates, and if equipped with a supervision cluster the message, "Auto Stop conditions not met", appears on the LCD display.
- When the above indicator remains ON, or when the above message remains displayed, we recommend you to have the IGS system checked by an authorized HYUNDAI dealer.

To deactivate the ISG system

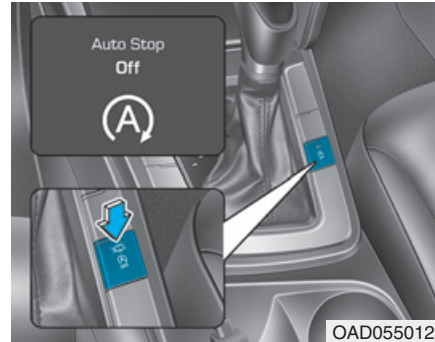

- Press the ISG OFF button to deactivate the ISG system. Then, the ISG OFF button indicator illuminates, and if equipped with a supervision cluster the message, "Auto Stop Off", appears on the LCD display.
- Press the ISG OFF button again to reactivate the ISG system. Then, the ISG OFF button indicator turns OFF.

ISG system malfunction

The ISG system may not operate: When there is a malfunction with the ISG sensors or the ISG system.

The followings occur, when there is a malfunction with the ISG system:

- The auto stop indicator ((A)) will blink in yellow.

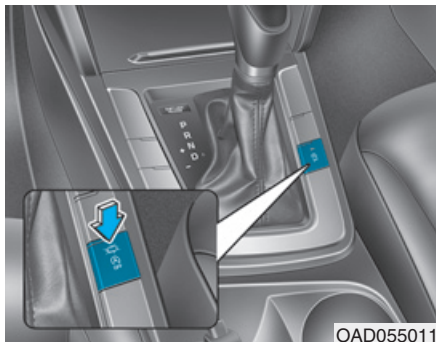

- The light on the ISG OFF button will illuminate.

i Information

- When you cannot turn off the ISG OFF button indicator by pressing the ISG OFF button, or when the malfunction with the ISG system persists, we recommend you to contact an authorized HYUNDAI dealer.
- You can turn off the ISG OFF button indicator by driving over 80 km/h (50 mph) for up to 2 hours with the fan speed below the 2nd position. If the ISG OFF button indicator remains ON, we recommend you to contact an authorized HYUNDAI dealer.

⚠ WARNING

When the engine is in auto stop mode, the engine may restart. Before leaving the vehicle or checking the engine compartment, stop the engine by placing the ignition switch to the LOCK/OFF position or removing the ignition key.

The battery sensor deactivation

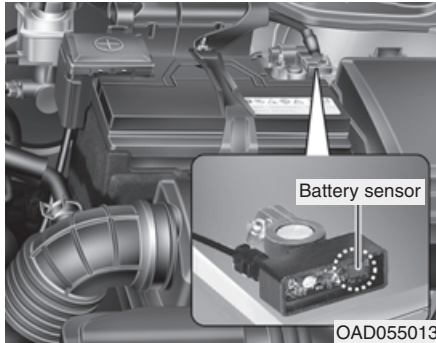

The battery sensor is deactivated, when the battery is disconnected from the negative pole for maintenance purpose.

In this case, the ISG system is limitedly operated due to the battery sensor deactivation. Thus, the driver needs to take the following procedures to reactivate the battery sensor after disconnecting the battery.

Prerequisites to reactivate the battery sensor

Keep the engine in the OFF status for 4 hours, and attempt to restart the engine 3 to 4 times for the battery-sensor reactivation.

Pay extreme caution not to connect any accessories (i.e. navigation and black box) to the vehicle with the engine in the OFF status. If not, the battery sensor may not be reactivated.

***i* Information**

The ISG system may not operate in the following situations.

- There is a malfunction with the IGS system.
- The battery is weak.
- The brake vacuum pressure is low.

In those cases, we recommend you to have the ISG system checked by an authorized HYUNDAI dealer.

NOTICE

- **Use only the genuine HYUNDAI ISG battery for replacement. If not, the ISG system may not normally operate.**
- **Do not recharge the ISG battery with a general battery charger. If not, it may damage or explode the ISG battery.**
- **Do not remove the battery cap. If not, the battery electrolyte, which is harmful to the human body, may leak out.**

DRIVE MODE INTEGRATED CONTROL SYSTEM (IF EQUIPPED)

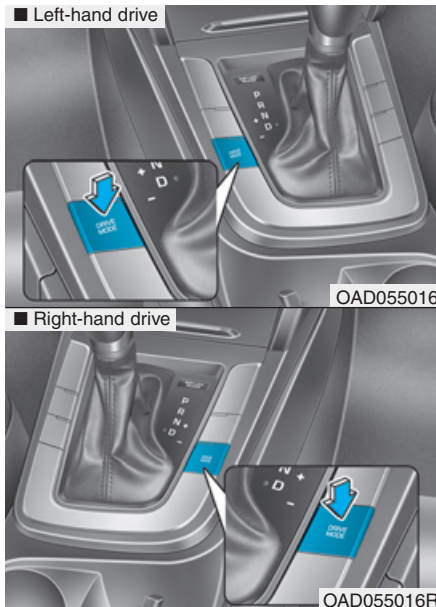

The drive mode may be selected according to the driver's preference or road condition.

The system resets to be in the NORMAL mode (except if it is in ECO mode), when the engine is restarted.

i Information

If there is a problem with the instrument cluster, the drive mode will be in NORMAL mode and may not change to ECO mode or SPORT mode.

The mode changes, as below, whenever the DRIVE MODE button is pressed.



When NORMAL mode is selected, it is not displayed on the instrument cluster.

ECO mode



When the Drive Mode is set to ECO mode, the engine and transmission control logic are changed to maximize fuel efficiency.

- When the ECO mode is selected by pressing the DRIVE MODE button, the ECO indicator (green color) will illuminate.
- If the vehicle is set to ECO mode, when the engine is turned OFF and restarted the Drive Mode setting will remain in ECO mode.

i Information

Fuel efficiency depends on the driver's driving habit and road condition.

When the ECO mode is activated:

- The acceleration response may be slightly reduced as the accelerator pedal is depressed moderately.
- The air conditioner performance may be limited.
- The shift pattern of the automatic transmission may change.
- The engine noise may get louder.

The above situations are normal conditions when the ECO mode is activated to improve fuel efficiency.

Limitation of the ECO mode operation:

If the following conditions occur while the ECO mode is operating, the system operation is limited even though there is no change in the ECO indicator.

- When the coolant temperature is low:
The system will be limited until engine performance becomes normal.
- When driving up a hill:
The system will be limited to gain power when driving uphill because engine torque is restricted.
- When driving the vehicle with the automatic transmission or the dual clutch transmission gear shift lever in manual shift mode:
The system will be limited according to the shift location.
- When the accelerator pedal is deeply depressed for a few seconds:
The system will be limited, judging that the driver wants to speed up.

SPORT mode

 A rectangular icon with the word "SPORT" in a bold, sans-serif font, enclosed in a double-line border.

SPORT mode manages the driving dynamics by automatically adjusting the steering effort, the engine and transmission control logic for enhanced driver performance.

- When SPORT mode is selected by pressing the DRIVE MODE button, the SPORT indicator (orange color) will illuminate.
- Whenever the engine is restarted, the Drive Mode will revert back to NORMAL mode. If SPORT mode is desired, re-select SPORT mode from the DRIVE MODE button.
- When SPORT mode is activated:
 - The engine rpm will tend to remain raised over a certain length of time even after releasing the accelerator
 - Upshifts are delayed when accelerating

***i* Information**

In SPORT mode, the fuel efficiency may decrease.

BLIND SPOT DETECTION SYSTEM (BSD) (IF EQUIPPED)

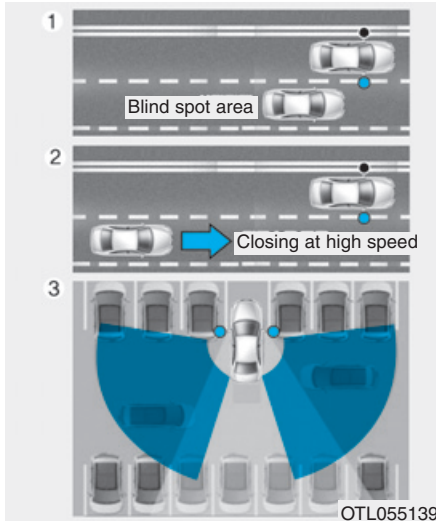

The Blind Spot Detection System (BSD) uses radar sensors in the rear bumper to monitor and warn the driver of an approaching vehicle in the driver's blind spot area.

The system monitors the rear area of the vehicle and provides information to the driver with an audible alert and a indicator on the outside side view mirrors.

(1) BSD (Blind Spot Detection)

The blind spot detection range varies relative to vehicle speed. Note that if your vehicle is traveling much faster than the vehicles around you, the warning will not occur.

(2) LCA (Lane Change Assist)

The Lane Change Assist feature will alert you when a vehicle is approaching in an adjacent lane at a high rate of speed. If the driver activates the turn signal when the system detects an oncoming vehicle, the system sounds an audible alert.

(3) RCTA (Rear Cross Traffic Alert)

The Rear Cross Traffic Alert feature monitors approaching cross traffic from the left and right side of the vehicle when your vehicle is in reverse. The feature will operate when the vehicle is moving in reverse below about 10 km/h (6 mph). If oncoming cross traffic is detected a warning chime will sound.

WARNING

- **Always be aware of road conditions while driving and be alert for unexpected situations even though the Blind Spot Detection System is operating.**
- **The Blind Spot Detection System (BSD) is a supplemental system to assist you. Do not entirely rely on the system. Always pay attention, while driving, for your safety.**
- **The Blind Spot Detection System (BSD) is not a substitute for proper and safe driving. Always drive safely and use caution when changing lanes or backing up the vehicle. The Blind Spot Detection System (BSD) may not detect every object alongside the vehicle.**

BSD (Blind Spot Detection) / LCA (Lane Change Assist)

Operating conditions

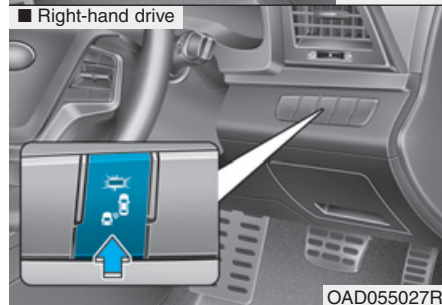
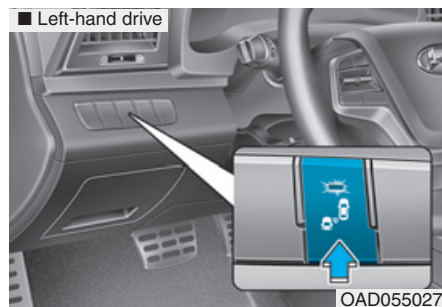

To operate:

Press the BSD switch with the Ignition switch in the ON position.

The indicator on the BSD switch will illuminate. When the vehicle speed exceeds 30 km/h (20 mph), the system will be activated.

To cancel:

Press the BSD switch again. The indicator on the switch will go off.

When the system is not used, turn the system off by turning off the switch.

i Information

- If the engine is turned off then on again, the BSD system returns to the previous state.
- When the system is turned on, the warning light will illuminate for 3 seconds on the outside rearview mirror.

Operating conditions

The system will activate when:

1. The system is on.
2. The vehicle speed is above about 30 km/h (20 mph).
3. An oncoming vehicle is detected in the blind spot area.

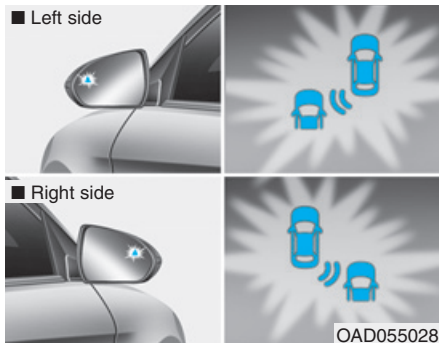

First stage alert

If a vehicle is detected within the boundary of the system, a warning light will illuminate on the outside rearview mirror.

Once the detected vehicle is no longer within the blind spot area, the warning will turn off according to the driving conditions of the vehicle.



Second stage alert

A warning chime to alert the driver will activate when:

1. A vehicle has been detected in the blind spot area by the radar system (the warning light will illuminate on the outside rearview mirror) AND
2. The turn signal is applied (same side as where the vehicle is being detected).

When this alert is activated, the warning light on the outside rearview mirror will also blink.

If you turn off the turn signal indicator, the warning chime will be deactivated.

- The second stage alarm may be deactivated.
 - To activate the warning chime: Go to the User Settings Mode → Sound and select "BSD" on the LCD display.
 - To deactivate the warning chime: Go to the User Settings Mode → Sound and deselect "BSD" on the LCD display.

i Information

The warning chime function helps alert the driver. Deactivate this function only when it is necessary

Detecting sensor



The sensors are located inside the rear bumper.

Always keep the rear bumper clean for proper operation of the system.

Warning message

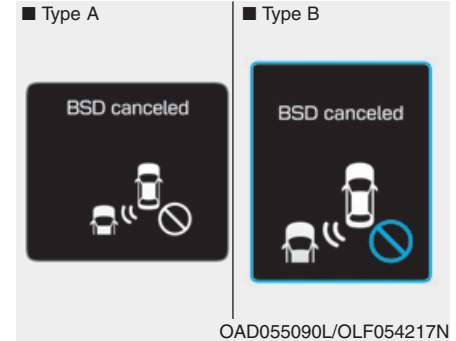

BSD canceled

- This warning message may appear when :
 - One or both of the sensors on the rear bumper is blocked by dirt or snow or a foreign object.
 - Driving in rural areas where the BSD sensor does not detect another vehicle for an extended period of time.
 - When there is inclement weather such as heavy snow or rain.

If any of these conditions occur, the light on the BSD switch and the system will turn off automatically.

When the BSD canceled warning message is displayed in the cluster, check to make sure that the rear bumper is free from any dirt or snow in the areas where the sensor is located. Remove any dirt, snow, or foreign material that could interfere with the radar sensors.

After any dirt or debris is removed, the BSD system should operate normally after about 10 minutes of driving the vehicle.

If the system still does not operate normally have your vehicle inspected by an authorized HYUNDAI dealer.

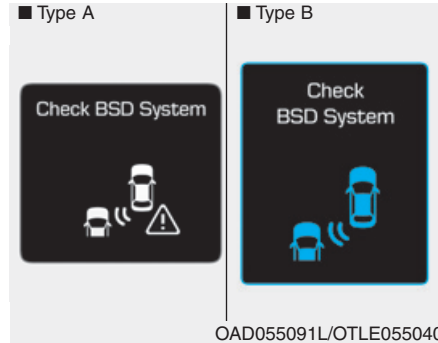

Check BSD system

If there is a problem with the BSD system, a warning message will appear and the light on the switch will turn off. The system will turn off automatically. We recommend that you have your vehicle inspected by an authorized HYUNDAI dealer.

RCTA (Rear Cross Traffic Alert) (if equipped)

The Rear Cross Traffic Alert feature monitors approaching cross traffic from the left and right side of the vehicle when your vehicle is in reverse.

Operating conditions

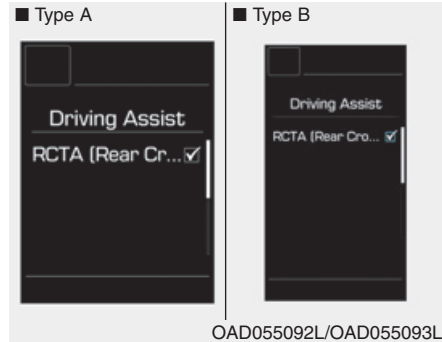

To operate:

Go to the User Settings mode (Driving Assist) and select Rear Cross Traffic Alert on the LCD display (**For more details, refer to "LCD Display" in chapter 3.**). The system will turn on and standby to activate. The system will activate when vehicle speed is below 10 km/h (6.2 mph) and with the shift lever in R (Reverse).

i Information

The Rear Cross Traffic Alert (RCTA) detecting range is approximately 0.5 m ~ 20 m (1 ft ~ 65 ft). An approaching vehicle will be detected if their vehicle speed is within 4 km/h ~ 36 km/h (2.5 ~ 22.5 mph).

Note that the detecting range may vary under certain conditions. As always, use caution and pay close attention to your surroundings when backing up your vehicle.

Warning type

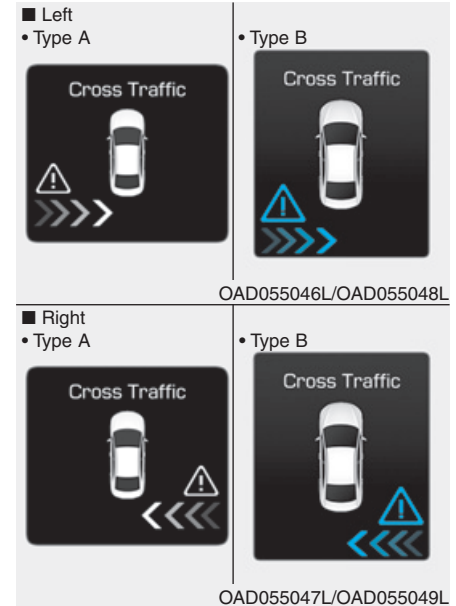

If the vehicle detected by the sensors approaches your vehicle, the warning chime will sound, the warning light on the outside rearview mirror will blink and a message will appear on the LCD display.

i Information

- The warning chime will turn off when the detected vehicle moves out of the sensing area or if your vehicle is moved away from the detected vehicle.
- The system may not operate properly due to other factors or circumstances. Always pay attention to your surrounding.
- If the sensing area near the rear bumper is blocked by either a wall or barrier or by a parked vehicle, the system sensing area may be reduced.

⚠ WARNING

- The warning light on the outside rearview mirror will illuminate whenever a vehicle is detected at the rear side by the system.

To avoid accidents, do not focus only on the warning light and neglect to see the surrounding of the vehicle.

- Drive safely even though the vehicle is equipped with a Blind Spot Detection System (BSD) and Rear Cross Traffic Alert (RCTA). Do not solely rely on the system but check your surrounding before changing lanes or backing the vehicle up.

The system may not alert the driver in some conditions so always check your surroundings while driving.

(Continued)

(Continued)

- The Blind Spot Detection System (BSD) and Rear Cross Traffic Alert (RCTA) are not a substitute for proper and safe driving practices. Always drive safely and use caution when changing lanes or backing up your vehicle. The Blind Spot Detection System (BSD) may not detect every object alongside the vehicle.

NOTICE

- The system may not work properly when the bumper has been damaged, or if the rear bumper has been replaced or repaired.
- The sensing range differs somewhat according to the width of the road. When the road is narrow, the system may detect other vehicles in the next lane.
- The system may turn off due to strong electromagnetic waves.

Non-operating condition

The BSD indicator on the outer side view mirror may not illuminate properly when:

- The outside rearview mirror housing is damaged.
- The mirror is covered with dirt, snow, or debris.
- The window is covered with dirt, snow, or debris.
- The window is tinted.

Limitations of the system

The driver must be cautious in the below situations, because the system may not detect other vehicles or objects in certain circumstances.

- The vehicle drives on a curved road or through a tollgate.
- The sensor is polluted with rain, snow, mud, etc.
- The rear bumper where the sensor is located is covered with a foreign object such as a bumper sticker, a bumper guard, a bike stand, etc.
- The rear bumper is damaged, or the sensor is out of the original default position.
- The vehicle height gets lower or higher due to heavy loading in a trunk, abnormal tire pressure, etc.
- The vehicle drives in inclement weather such as heavy rain or snow.
- There is a fixed object near the vehicle, such as a guardrail.
- A big vehicle is near such as a bus or truck.

- A motorcycle or bicycle is near.
- A flat trailer is near.
- If the vehicle has started at the same time as the vehicle next to you and has accelerated.
- When the other vehicle passes at a very fast speed.
- While changing lanes.
- While going down or up a steep road where the height of the lane is different.
- When the other vehicle approaches very close.
- When a trailer or carrier is installed.
- When the temperature of the rear bumper is high.
- When the sensors are blocked by other vehicles, walls or parking-lot pillars.
- When the detected vehicle also moves back, as your vehicle drives back.
- If there are small objects in the detecting area such as a shopping cart or a baby carriage.
- If there is a low height vehicle such as a sports car.
- When other vehicles are close to your vehicle.
- When the vehicle in the next lane moves two lanes away from you OR when the vehicle two lanes away moves to the next lane from you.

CRUISE CONTROL (IF EQUIPPED)

Cruise Control operation

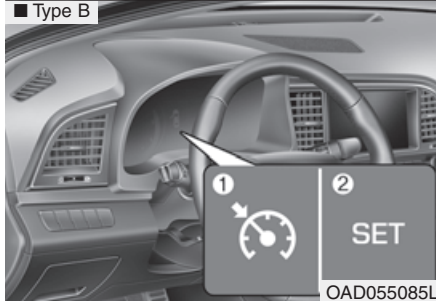
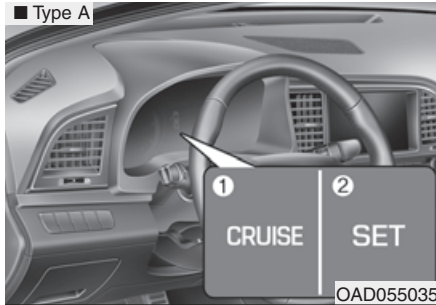

1. CRUISE indicator
2. SET indicator

The Cruise Control system allows you to drive at speeds above 30 km/h (20 mph) without depressing the accelerator pedal.

WARNING

Take the following precautions:

- If the Cruise Control is left on, (CRUISE indicator light in the instrument cluster is illuminated) the Cruise Control can be activated unintentionally. Keep the Cruise Control system off (CRUISE indicator light OFF) when the Cruise Control is not in use, to avoid inadvertently setting a speed.
- Use the Cruise Control system only when traveling on open highways in good weather.

(Continued)

(Continued)

- Do not use the Cruise Control when it may be unsafe to keep the vehicle at a constant speed:
 - When driving in heavy traffic or when traffic conditions make it difficult to drive at a constant speed
 - When driving on rainy, icy, or snow-covered roads
 - When driving on hilly or windy roads
 - When driving in windy areas

NOTICE

During cruise-speed driving of a manual transmission vehicle, do not shift into neutral without depressing the clutch pedal, since the engine will be overrevved. If this happens, depress the clutch pedal or press the cruise control ON / OFF button.

i Information

- During normal cruise control operation, when the SET switch is activated or reactivated after applying the brakes, the cruise control will energize after approximately 3 seconds. This delay is normal.
- Before activating the cruise control function, the system will check to verify that the brake switch is operating normally. Depress the brake pedal at least once after turning ON the ignition or starting the engine.

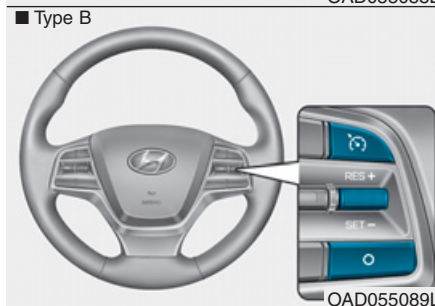
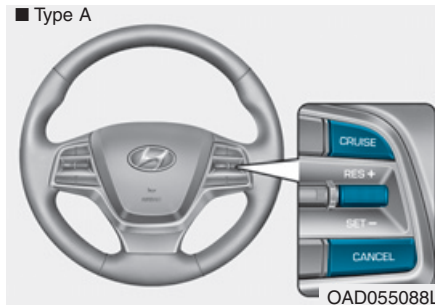

Cruise control switch

CANCEL/O : Cancels cruise control operation.

CRUISE /  : Turns cruise control system on or off.

RES+: Resumes or increases cruise control speed.

SET-: Sets or decreases cruise control speed.

To set Cruise Control speed

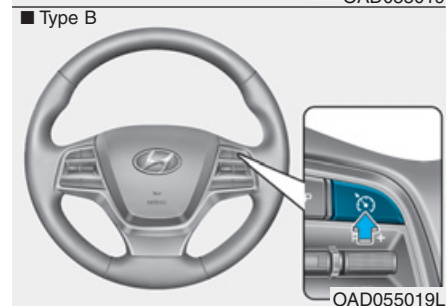
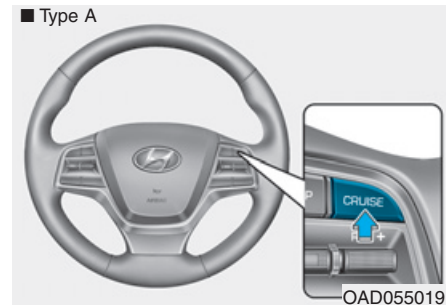

1. Press the CRUISE /  button on the steering wheel to turn the system on. The CRUISE indicator will illuminate.

- Accelerate to the desired speed, which must be more than 30 km/h (20 mph).

i Information - Manual transmission

For manual transmission vehicles, you should depress the brake pedal at least once to set the cruise control after starting the engine.

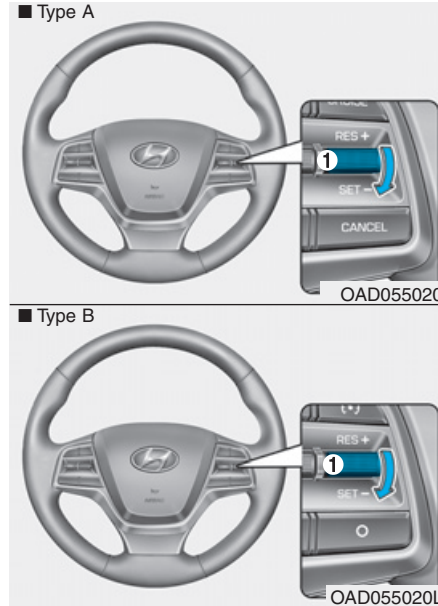

- Push the toggle switch (1) down (SET -), and release it. The SET indicator light will illuminate.
- Release the accelerator pedal.

i Information

On a steep slope, the vehicle may slightly slow down or speed up, while driving uphill or downhill.

To increase Cruise Control speed

■ Type A



■ Type B



- Push the toggle switch (1) up (RES+) and hold it, while monitoring the SET speed on the instrument cluster.

Release the toggle switch when the desired speed is shown and the vehicle will accelerate to that speed.

- Push the toggle switch (1) up (RES+) and release it immediately. The cruising speed will increase 2.0 km/h (1.2 mph) each time the toggle switch is operated in this manner.
- Depress the accelerator pedal. When the vehicle attains the desired speed, push the toggle switch (1) down (SET-).

To decrease Cruise Control speed

■ Type A



■ Type B



- Push the toggle switch (1) down (SET-) and hold it. Your vehicle will gradually slow down. Release the toggle switch at the speed you want to maintain.

- Push the toggle switch (1) down (SET-) and release it immediately. The cruising speed will decrease 2.0 km/h (1.2 mph) each time the toggle switch is operated in this manner.
- Lightly tap the brake pedal. When the vehicle attains the desired speed, push the toggle switch (1) down (SET-).

To temporarily accelerate with the Cruise Control ON

Depress the accelerator pedal. When you take your foot off the accelerator, the vehicle will return to the previously set speed.

If you push the toggle switch down (SET-) at the increased speed, the Cruise Control will maintain the increased speed.

Cruise Control will be canceled when:

■ Type A

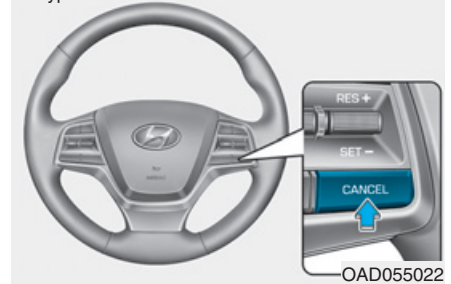

■ Type B



- Depressing the brake pedal.
- Depressing the clutch pedal. (for manual transmission vehicle)

- Pressing the CANCEL / O button located on the steering wheel.
- Pressing the CRUISE /  button. Both the CRUISE indicator and the SET indicator will turn OFF.
- Moving the shift lever into N (Neutral). (for automatic transmission/dual clutch transmission)
- Decreasing the vehicle speed lower than the speed by 20 km/h (12 mph).
- Decreasing the vehicle speed to less than approximately 30 km/h (20 mph).
- The ESC (Electronic Stability Control) is operating.
- Downshifting to 2nd gear when in Manual Shift mode.

Information

Each of the above actions will cancel Cruise Control operation (the SET indicator light in the instrument cluster will go off), but only pressing the CRUISE button will turn the system off. If you wish to resume Cruise Control operation, push the toggle switch up (RES+) located on your steering wheel. You will return to your previously preset speed, unless the system was turned off using the CRUISE button.

To resume preset Cruising speed

■ Type A



■ Type B



Push the toggle switch (1) up (RES+). If the vehicle speed is over 30 km/h (20 mph), the vehicle will resume the preset speed.

To turn Cruise Control off

■ Type A

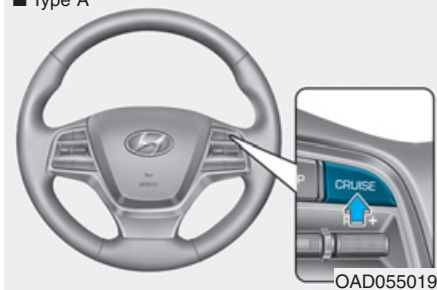

■ Type B

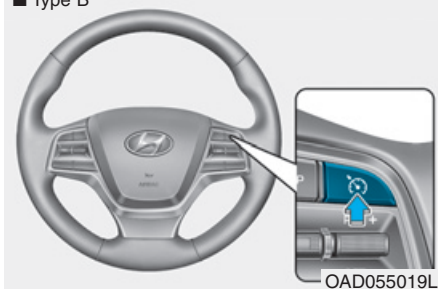

- Press the CRUISE /  button (the CRUISE indicator light will go off).
- Turn the engine OFF.

SPECIAL DRIVING CONDITIONS

Hazardous driving conditions

When hazardous driving elements are encountered such as water, snow, ice, mud and sand, take the bellow suggestions:

- Drive cautiously and keep a longer braking distance.
- Avoid abrupt braking or steering.
- When your vehicle is stuck in snow, mud, or sand, use second gear. Accelerate slowly to avoid unnecessary wheel spin.
- Put sand, rock salt, tire chains or other non-slip materials under the wheels to provide additional traction while the vehicle becomes stuck in ice, snow, or mud.

WARNING

Downshifting with an automatic transmission while driving on slippery surfaces can cause an accident. The sudden change in tire speed could cause the tires to skid. Be careful when downshifting on slippery surfaces.

Rocking the vehicle

If it is necessary to rock the vehicle to free it from snow, sand, or mud, first turn the steering wheel right and left to clear the area around your front wheels. Then, shift back and forth between R (Reverse) and a forward gear.

Try to avoid spinning the wheels, and do not race the engine.

To prevent transmission wear, wait until the wheels stop spinning before shifting gears. Release the accelerator pedal while shifting, and press lightly on the accelerator pedal while the transmission is in gear. Slowly spinning the wheels in forward and reverse directions causes a rocking motion that may free the vehicle.

WARNING

If the vehicle is stuck and excessive wheel spin occurs, the temperature in the tires can increase very quickly. If the tires become damaged, a tire blow out or tire explosion can occur. This condition is dangerous - you and others may be injured. Do not attempt this procedure if people or objects are anywhere near the vehicle.

If you attempt to free the vehicle, the vehicle can overheat quickly, possibly causing an engine compartment fire or other damage. Try to avoid spinning the wheels as much as possible to prevent overheating of either the tires or the engine. DO NOT allow the vehicle to spin the wheels above 56 km/h (35 mph).

i Information

The ESC system (if equipped) must be turned OFF before rocking the vehicle.

NOTICE

If you are still stuck after rocking the vehicle a few times, have the vehicle pulled out by a tow vehicle to avoid engine overheating, possible damage to the transmission, and tire damage. See "Towing" in chapter 6.

Smooth cornering

Avoid braking or gear changing in corners, especially when roads are wet. Ideally, corners should always be taken under gentle acceleration.

Driving at night

Night driving presents more hazards than driving in the daylight. Here are some important tips to remember:

- Slow down and keep more distance between you and other vehicles, as it may be more difficult to see at night, especially in areas where there may not be any street lights.
- Adjust your mirrors to reduce the glare from other driver's headlamps.
- Keep your headlamps clean and properly aimed. Dirty or improperly aimed headlamps will make it much more difficult to see at night.
- Avoid staring directly at the headlamps of oncoming vehicles. You could be temporarily blinded, and it will take several seconds for your eyes to readjust to the darkness.

Driving in the rain

Rain and wet roads can make driving dangerous. Here are a few things to consider when driving in the rain or on slick pavement:

- Slow down and allow extra following distance. A heavy rainfall makes it harder to see and increases the distance needed to stop your vehicle.
- Turn OFF your Cruise Control. (if equipped)
- Replace your windshield wiper blades when they show signs of streaking or missing areas on the windshield.
- Be sure your tires have enough tread. If your tires do not have enough tread, making a quick stop on wet pavement can cause a skid and possibly lead to an accident. **See "Tire Tread" in chapter 7.**
- Turn on your headlamps to make it easier for others to see you.
- Driving too fast through large puddles can affect your brakes. If you must go through puddles, try to drive through them slowly.

- If you believe your brakes may be wet, apply them lightly while driving until normal braking operation returns.

Hydroplaning

If the road is wet enough and you are going fast enough, your vehicle may have little or no contact with the road surface and actually ride on the water. The best advice is SLOW DOWN when the road is wet.

The risk of hydroplaning increases as the depth of tire tread decreases, refer to "Tire Tread" in chapter 7.

Driving in flooded areas

Avoid driving through flooded areas unless you are sure the water is no higher than the bottom of the wheel hub. Drive through any water slowly. Allow adequate stopping distance because brake performance may be reduced.

After driving through water, dry the brakes by gently applying them several times while the vehicle is moving slowly.

Highway driving

Tires

Adjust the tire inflation, as specified. Under-inflation may overheat or damage the tires.

Do not install worn-out or damaged tires, which may reduce traction or fail the braking operation.

Information

Never over-inflate your tires above the maximum inflation pressure, as specified on your tires.

Fuel, engine coolant and engine oil

Driving at higher speeds on the highway consumes more fuel and is less efficient than driving at a slower, more moderate speed. Maintain a moderate speed in order to conserve fuel when driving on the highway.

Be sure to check both the engine coolant level and the engine oil before driving.

Drive belt

A loose or damaged drive belt may overheat the engine.

WINTER DRIVING

The severe weather conditions of winter quickly wear out tires and cause other problems. To minimize winter driving problems, you should take the following suggestions:

Snow or icy conditions

You need to keep sufficient distance between your vehicle and the vehicle in front of you.

Apply the brakes gently. Speeding, rapid acceleration, sudden brake applications, and sharp turns are potentially very hazardous practices. During deceleration, use engine braking to the fullest extent. Sudden brake applications on snowy or icy roads may cause the vehicle to skid.

To drive your vehicle in deep snow, it may be necessary to use snow tires or to install tire chains on your tires.

Always carry emergency equipment. Some of the items you may want to carry include tire chains, tow straps or chains, a flashlight, emergency flares, sand, a shovel, jumper cables, a window scraper, gloves, ground cloth, coveralls, a blanket, etc.

Snow tires

WARNING

Snow tires should be equivalent in size and type to the vehicle's standard tires. Otherwise, the safety and handling of your vehicle may be adversely affected.

If you mount snow tires on your vehicle, make sure to use radial tires of the same size and load range as the original tires. Mount snow tires on all four wheels to balance your vehicle's handling in all weather conditions. The traction provided by snow tires on dry roads may not be as high as your vehicle's original equipment tires. Check with the tire dealer for maximum speed recommendations.

Information

Do not install studded tires without first checking local and municipal regulations for possible restrictions against their use.

Tire chains

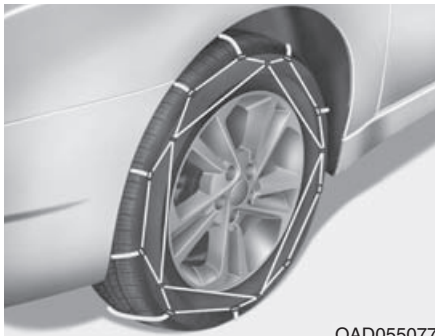

OAD055077

Since the sidewalls of radial tires are thinner than other types of tires, they may be damaged by mounting some types of tire chains on them. Therefore, the use of snow tires is recommended instead of tire chains. Do not mount tire chains on vehicles equipped with aluminum wheels; if unavoidable use a wire type chain. If tire chains must be used, use genuine HYUNDAI parts and install the tire chain after reviewing the instructions provided with the tire chains. Damage to your vehicle caused by improper tire chain use is not covered by your vehicle manufacturer's warranty.

WARNING

The use of tire chains may adversely affect vehicle handling:

- Drive less than 30 km/h (20 mph) or the chain manufacturer's recommended speed limit, whichever is lower.
- Drive carefully and avoid bumps, holes, sharp turns, and other road hazards, which may cause the vehicle to bounce.
- Avoid sharp turns or locked wheel braking.

Information

- Install tire chains on the front tires. It should be noted that installing tire chains on the tires will provide a greater driving force, but will not prevent side skids.
- Do not install studded tires without first checking local and municipal regulations for possible restrictions against their use.

Chain Installation

When installing tire chains, follow the manufacturer's instructions and mount them as tightly possible. Drive slowly (less than 30 km/h (20 mph)) with chains installed. If you hear the chains contacting the body or chassis, stop and tighten them. If they still make contact, slow down until the noise stops. Remove the tire chains as soon as you begin driving on cleared roads.

When mounting snow chains, park the vehicle on level ground away from traffic. Turn on the vehicle Hazard Warning Flasher and place a triangular emergency warning device behind the vehicle (if available). Always place the vehicle in P (Park), apply the parking brake and turn off the engine before installing snow chains.

NOTICE

When using tire chains:

- **Wrong size chains or improperly installed chains can damage your vehicle's brake lines, suspension, body and wheels.**
- **Use SAE "S" class or wire chains.**
- **If you hear noise caused by chains contacting the body, retighten the chain to prevent contact with the vehicle body.**
- **To prevent body damage, retighten the chains after driving 0.5~1.0 km (0.3~0.6 miles).**
- **Do not use tire chains on vehicles equipped with aluminum wheels. If unavoidable, use a wire type chain.**
- **Use wire chains less than 15 mm (0.59 in) wide to prevent damage to the chain's connection.**

Winter Precautions

Use high quality ethylene glycol coolant

Your vehicle is delivered with high quality ethylene glycol coolant in the cooling system. It is the only type of coolant that should be used because it helps prevent corrosion in the cooling system, lubricates the water pump and prevents freezing. Be sure to replace or replenish your coolant in accordance with the maintenance schedule in section 7. Before winter, have your coolant tested to assure that its freezing point is sufficient for the temperatures anticipated during the winter.

Check battery and cables

The winter temperature increases the battery consumption. **Inspect the battery and cables, as specified in the chapter 7.** The battery charging level can be checked by an authorized HYUNDAI dealer or in a service station.

Change to "winter weight" oil if necessary

In some regions during winter, it is recommended to use the "winter weight" oil with lower viscosity. For further information, refer to the chapter 8. When you are not sure about a type of winter weight oil, consult an authorized HYUNDAI dealer.

Check spark plugs and ignition system

Inspect the spark plugs, as specified in the chapter 7. If necessary, replace them. Also check all ignition wirings and components for any cracks, wear-out, and damage.

To prevent locks from freezing

To prevent the locks from being frozen, spray approved de-icing fluid or glycerin into key holes. When a lock opening is already covered with ice, spray approved de-icing fluid over the ice to remove it. When an internal part of a lock freezes, try to thaw it with a heated key. Carefully use the heated key to avoid an injury.

Use approved window washer anti-freeze solution in system

To prevent the window washer from being frozen, add authorized window washer anti-freeze solution, as specified on the window washer container. Window washer anti-freeze solution is available from an authorized HYUNDAI dealer, and so are the most vehicle accessory outlets. Do not use engine coolant or other types of anti-freeze solution to prevent any damage to the vehicle paint.

Do not let your parking brake freeze

Under some conditions your parking brake can freeze in the engaged position. This is most likely to happen when there is an accumulation of snow or ice around or near the rear brakes or if the brakes are wet. When there is the risk that your parking brake may freeze, temporarily apply it with the shift lever in P (Park). Also, block the rear wheels in advance, so the vehicle may not roll. Then, release the parking brake.

Do not let ice and snow accumulate underneath

Under some conditions, snow and ice can build up under the fenders and interfere with the steering. When driving in such conditions during the severe winter, you should check underneath the vehicle on a regular basis, so that moving the front wheels and the steering components is unblocked.

Carry emergency equipment

In accordance with weather conditions, you should carry appropriate emergency equipment, while driving. Some of the items you may want to carry include tire chains, tow straps or chains, flashlight, emergency flares, sand, shovel, jumper cables, window scraper, gloves, ground cloth, coveralls, blanket, etc.

Do not place objects or materials in the engine compartment

Putting objects or materials in the engine compartment may cause an engine failure or combustion, because those may block the engine cooling. Such damage will not be covered by the manufacturer's warranty.

TRAILER TOWING

If you are considering to tow with your vehicle, you should first check with your country's Department of Motor Vehicles to determine legal requirements. Since laws vary the requirements for towing trailers, cars, or other types of vehicles or apparatus may differ. Ask an authorized HYUNDAI dealer for further details before towing.

Remember that trailering is different than just driving your vehicle by itself. Trailering means changes in handling, durability, and fuel economy. Successful, safe trailering requires correct equipment, and it has to be used properly. Damage to your vehicle caused by improper trailer towing is not covered by your vehicle manufacturer's warranty.

This section contains many time-tested, important trailering tips and safety rules. Many of these are important for your safety and that of your passengers. Please read this section carefully before you pull a trailer.

WARNING

Take the following precautions:

- **If you don't use the correct towing equipment, or if you drive improperly while towing, you can lose control of the vehicle when pulling a trailer. For example, if the trailer is too heavy, the braking performance may be reduced. You and your passengers could be seriously or fatally injured. Pull a trailer only if you have followed all the steps in this section.**
- **Before towing, make sure the total trailer weight, GCW (Gross Combination Weight), GVW (Gross Vehicle Weight), GAW (Gross Axle Weight) and trailer tongue load are all within the limits.**

i Information - For Europe

- **The technically permissible maximum load on the rear axle(s) may be exceeded by not more than 15 % and the technically permissible maximum laden mass of the vehicle may be exceeded by not more than 10% or 100 kg (220.4 lbs), whichever value is lower. In this case, do not exceed 100 km/h (62.1 mph) for vehicle of category M1 or 80 km/h (49.7 mph) for vehicle of category N1.**
- **When a vehicle of category M1 is towing a trailer, the additional load imposed at the trailer coupling device may cause the tire maximum load ratings to be exceeded, but not by more than 15%. In this case, do not exceed 100 km/h (62.1 mph) and increase the tire inflation pressure by at least 0.2 bar.**

If you decide to pull a trailer

Here are some important points if you decide to pull a trailer:

- Consider using a sway control. You can ask a trailer hitch dealer about sway control.
 - Do not do any towing with your vehicle during its first 2,000 km (1,200 miles) in order to allow the engine to properly break in. Failure to heed this caution may result in serious engine or transmission damage.
 - When towing a trailer, be sure to consult an authorized HYUNDAI dealer for further information on additional requirements such as a towing kit, etc.
 - Always drive your vehicle at a moderate speed (less than 100 km/h (60 mph)) or posted towing speed limit.
- On a long uphill grade, do not exceed 70 km/h (45 mph) or the posted towing speed limit, whichever is lower.
 - Carefully observe the weight and load limits provided in the following pages.

Trailer weight

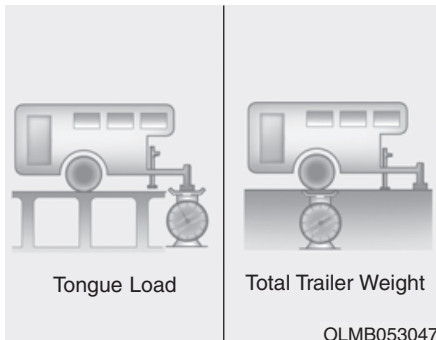

What is the maximum safe weight of a trailer? It should never weigh more than the maximum trailer weight with trailer brakes. But even that can be too heavy. It depends on how you plan to use your trailer. For example, speed, altitude, road grades, outside temperature and how often your vehicle is used to pull a trailer are all important. The ideal trailer weight can also depend on any special equipment that you have on your vehicle.

Tongue load

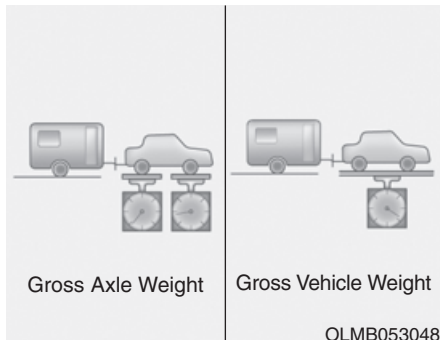

The tongue load is an important weight to measure because it affects the total Gross Vehicle Weight (GVW) of your vehicle. The trailer tongue should weigh a maximum of 10% of the total loaded trailer weight, within the limits of the maximum trailer tongue load permissible.

After you've loaded your trailer, weigh the trailer and then the tongue, separately, to see if the weights are proper. If they aren't, you may be able to correct them simply by moving some items around in the trailer.

WARNING

Take the following precautions:

- **Never load a trailer with more weight in the rear than in the front. The front should be loaded with approximately 60% of the total trailer load; the rear should be loaded with approximately 40% of the total trailer load.**
- **Never exceed the maximum weight limits of the trailer or trailer towing equipment. Improper loading can result in damage to your vehicle and/or personal injury. Check weights and loading at a commercial scale or highway patrol office equipped with scales.**

Reference weight and distance when towing a trailer

■ Except Western Europe

Item		Gasoline Engine				Diesel Engine	
		1.6 MPI		2.0 MPI		1.6 VGT	
		M/T	A/T	M/T	A/T	M/T	DCT
Maximum trailer weight kg (lbs.)	Without brake System	610 (1344)	610 (1344)	610 (1344)	610 (1344)	300 (661)	300 (661)
	With brake System	1200 (2645)	1100 (2425)	1200 (2645)	1100 (2425)	300 (661)	300 (661)
Maximum permissible static vertical load on the coupling device kg (lbs.)		1115 (2458)					
Recommended distance from rear wheel center to coupling point mm (inch)		1090 (43)					

M/T : Manual transmission

A/T : Automatic transmission

DCT : Dual clutch transmission

■ For Western Europe

Item		Gasoline Engine			
		1.6 MPI		2.0 MPI	
		M/T	A/T	M/T	A/T
Maximum trailer weight kg (lbs.)	Without brake System	300 (661)	300 (661)	300 (661)	300 (661)
	With brake System	300 (661)	300 (661)	300 (661)	300 (661)
Maximum permissible static vertical load on the coupling device kg (lbs.)		1115 (2458)			
Recommended distance from rear wheel center to coupling point mm (inch)		1090 (43)			

M/T : Manual transmission

A/T : Automatic transmission

Trailer towing equipment

Hitches

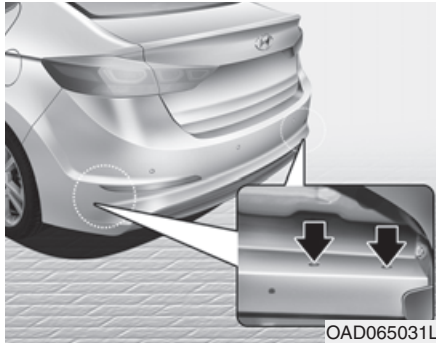

i Information

The mounting hole for hitches are located on both sides of the underbody behind the rear tires.

It's important to have the correct hitch equipment. Crosswinds, large trucks going by, and rough roads are a few reasons why you'll need the right hitch. Here are some rules to follow:

- Do you have to make any holes in the body of your vehicle when you install a trailer hitch? If you do, then be sure to seal the holes later when you remove the hitch. If you don't seal them, carbon monoxide (CO) from your exhaust can get into your vehicle, as well as dirt and water.
- The bumpers on your vehicle are not intended for hitches. Do not attach rental hitches or other bumper-type hitches to them. Use only a frame-mounted hitch that does not attach to the bumper.
- A HYUNDAI trailer hitch accessory is available at an authorized HYUNDAI dealer.

Safety chains

You should always attach chains between your vehicle and your trailer. Cross the safety chains under the tongue of the trailer so that the tongue will not drop to the road if it becomes separated from the hitch. Instructions about safety chains may be provided by the hitch manufacturer or trailer manufacturer. Follow the manufacturer's recommendation for attaching safety chains. Always leave just enough slack so you can turn with your trailer. And, never allow safety chains to drag on the ground.

Trailer brakes

If your trailer is equipped with a braking system, make sure it conforms your country's regulations and that it is properly installed and operating correctly.

If your trailer weighs more than the maximum trailer weight without trailer brakes loaded, then it needs its own brakes and they must be adequate. Be sure to read and follow the instructions for the trailer brakes so you'll be able to install, adjust and maintain them properly. Do not tap into your vehicle's brake system. Trailer brakes must be applied separately from your vehicle's brake system.

WARNING

Do not use a trailer with its own brakes unless you are absolutely certain that you have properly set up the brake system. This is not a task for amateurs. Use an experienced, competent trailer shop for this work.

Driving with a trailer

Towing a trailer requires a certain amount of experience. Before setting out for the open road, you must get to know your trailer. Acquaint yourself with the feel of handling and braking with the added weight of the trailer. And always keep in mind that the vehicle you are driving is now longer and not nearly as responsive as your vehicle is by itself.

Before you start, check the trailer hitch and platform, safety chains, electrical connector(s), lights, tires and brakes.

During your trip, occasionally check to be sure that the load is secure, and that the lights and trailer brakes are still working.

Distance

Stay at least twice as far behind the vehicle ahead as you would when driving your vehicle without a trailer. This can help you avoid situations that require heavy braking and sudden turns.

Passing

You will need more passing distance up ahead when you're towing a trailer. And, because of the increased vehicle length, you'll need to go much farther beyond the passed vehicle before you can return to your lane.

Backing up

Hold the bottom of the steering wheel with one hand. Then, to move the trailer to the left, move your hand to the left. To move the trailer to the right, move your hand to the right. Always back up slowly and, if possible, have someone guide you.

Making turns

When you're turning with a trailer, make wider turns than normal. Do this so your trailer won't strike soft shoulders, curbs, road signs, trees, or other objects. Avoid jerky or sudden maneuvers. Signal well in advance.

Turn signals

When you tow a trailer, your vehicle has to have a different turn signal flasher and extra wiring. The green arrows on your instrument panel will flash whenever you signal a turn or lane change. Properly connected, the trailer lights will also flash to alert other drivers you're about to turn, change lanes, or stop.

When towing a trailer, the green arrows on your instrument panel will flash for turns even if the bulbs on the trailer are burned out. Thus, you may think drivers behind you are seeing your signals when, in fact, they are not. It's important to check occasionally to be sure the trailer bulbs are still working. You must also check the lights every time you disconnect and then reconnect the wires.

WARNING

Do not connect a trailer lighting system directly to your vehicle's lighting system. Use an approved trailer wiring harness. Failure to do so could result in damage to the vehicle electrical system and/or personal injury. Consult an authorized HYUNDAI dealer for assistance.

Driving on hills

Reduce speed and shift to a lower gear before you start down a long or steep downgrade. If you don't shift down, you might have to use your brakes so much that they would get overheated and may not operate efficiently.

On a long uphill grade, shift down and reduce your speed to around 70 km/h (45 mph) to reduce the possibility of engine and transmission overheating.

If your trailer weighs more than the maximum trailer weight without trailer brakes and you have an automatic transmission, you should drive in D (Drive) when towing a trailer.

Operating your vehicle in D (Drive) when towing a trailer will minimize heat build-up and extend the life of your transmission.

NOTICE

To prevent engine and/or transmission (transmission) overheating:

- When towing a trailer on steep grades (in excess of 6%) pay close attention to the engine coolant temperature gauge to ensure the engine does not overheat. If the needle of the coolant temperature gauge moves towards “130 or H(Hot)”, pull over and stop as soon as it is safe to do so, and allow the engine to idle until it cools down. You may proceed once the engine has cooled sufficiently.
- When towing a trailer, your vehicle speed may be much slower than the general flow of traffic, especially when climbing an uphill grade. Use the right hand lane when towing a trailer on an uphill grade. Choose your vehicle speed according to the maximum posted speed limit for vehicles with trailers, the steepness of the grade, and your trailer weight.

(Continued)

(Continued)

- For vehicles equipped with the dual clutch transmission, some extra precaution should be taken when towing a trailer. Due to the added load on the transmission when towing a trailer, the clutches may get hot if the vehicle experiences excessive upshifting and downshifting.

Under certain conditions, such as repeated stop-and-go launches on steep grades, the transmission clutches may become overheated. When the clutches start to become overheated, the transmission safe protection mode logic is enabled. If the safe protection mode logic is enabled, the gear position indicator on the cluster LCD display blinks, a chime sounds, and a warning message will appear.

(Continued)

(Continued)

If the dual clutch transmission starts to become overheated, the gear shift characteristics may change. Gear shifts may become more abrupt. If continued operation while towing a trailer includes frequent and continuous upshifts and downshifts, the overheat warning message on the cluster LCD display may illuminate. If this occurs, stop the vehicle, apply the brakes or shift the vehicle to (P) Park, and allow the transmission to cool.

Parking on hills

Generally, if you have a trailer attached to your vehicle, you should not park your vehicle on a hill.

However, if you ever have to park your trailer on a hill, here's how to do it:

1. Pull the vehicle into the parking area.
Turn the steering wheel in the direction of the curb (right if headed down hill, left if headed up hill).
2. Shift the vehicle to P (Park, for automatic transmission vehicle) or neutral (for manual transmission vehicle).
3. Set the parking brake and shut off the vehicle.
4. Place wheel chocks under the trailer wheels on the down hill side of the wheels.
5. Start the vehicle, apply the brakes, shift to neutral, release the parking brake and slowly release the brakes until the trailer chocks absorb the load.

6. Reapply the brakes and parking brakes.
7. Move the shift lever to P (Park, for automatic transmission/dual clutch transmission vehicle) or 1st gear when the vehicle is parked on an uphill grade and in R (Reverse) on a downhill (for manual transmission vehicle).
8. Shut off the vehicle and release the vehicle brakes but leave the parking brake set.

WARNING

To prevent serious or fatal injury:

- **Do not get out of the vehicle without the parking brake firmly set. If you have left the engine running, the vehicle can move suddenly. You and others could be seriously or fatally injured.**
- **Do not apply the accelerator pedal to hold the vehicle on an uphill.**

Driving the vehicle after it has been parked on a hill

1. With the shift lever in P (Park, for automatic transmission/dual clutch vehicle) or neutral (for manual transmission vehicle), apply the brakes and hold the brake pedal down while performing the following:
 - Start your engine;
 - Shift into gear; and
 - Release the parking brake.
2. Slowly remove your foot from the brake pedal.
3. Drive slowly until the trailer is clear of the chocks.
4. Stop and have someone pick up and store the chocks.

Maintenance when towing a trailer

Your vehicle will need service more often when you regularly pull a trailer. Important items to pay particular attention to include engine oil, automatic transmission fluid, axle lubricant and cooling system fluid. Brake condition is another important item to frequently check. If you're trailering, it's a good idea to review these items before you start your trip. Don't forget to also maintain your trailer and hitch. Follow the maintenance schedule that accompanied your trailer and check it periodically. Preferably, inspect the vehicle and trailer at the start of each day's driving. Inspect the hitch mounting to make sure the hitch is properly secured to the vehicle. Inspect the trailer electrical wiring to make sure brake lights, turn signal lights, running lights, and hazard lights are working properly.

NOTICE

To prevent vehicle damage:

- **Due to higher load during trailer usage, overheating might occur on hot days or during uphill driving. If the coolant gauge indicates over-heating, switch off the air conditioner and stop the vehicle in a safe area to cool down the engine.**
- **When towing check the automatic transmission fluid more frequently. (Note: This is not applicable for vehicles equipped with the dual clutch transmission.)**
- **If your vehicle is not equipped with an air conditioner, you should install a condenser fan to improve engine performance when towing a trailer.**

VEHICLE WEIGHT

Two labels on your driver's door sill show how much weight your vehicle was designed to carry: the Tire and Loading Information Label and the Certification Label.

Before loading your vehicle, familiarize yourself with the following terms for determining your vehicle's weight ratings, from the vehicle's specifications and the Certification Label:

Base Curb Weight

This is the weight of the vehicle including a full tank of fuel and all standard equipment. It does not include passengers, cargo, or optional equipment.

Vehicle Curb Weight

This is the weight of your new vehicle when you picked it up from your dealer plus any aftermarket equipment.

Cargo Weight

This figure includes all weight added to the Base Curb Weight, including cargo and optional equipment.

GAW (Gross Axle Weight)

This is the total weight placed on each axle (front and rear) - including vehicle curb weight and all payload.

GAWR (Gross Axle Weight Rating)

This is the maximum allowable weight that can be carried by a single axle (front or rear). These numbers are shown on the Certification Label. The total load on each axle must never exceed its GAWR.

GVW (Gross Vehicle Weight)

This is the Base Curb Weight plus actual Cargo Weight plus passengers.

GVWR (Gross Vehicle Weight Rating)

This is the maximum allowable weight of the fully loaded vehicle (including all options, equipment, passengers and cargo). The GVWR is shown on the Certification Label located on the driver's door sill.

Overloading

WARNING

The Gross Axle Weight Rating (GAWR) and the Gross Vehicle Weight Rating (GVWR) for your vehicle are on the Certification Label attached to the driver's (or front passenger's) door. Exceeding these ratings can cause an accident or vehicle damage. You can calculate the weight of your load by weighing the items (and people) before putting them in the vehicle. Be careful not to overload your vehicle.

What to do in an emergency

Hazard warning flasher	6-2	If you have a flat tire.....	6-16
In case of an emergency while driving	6-2	Jack and tools.....	6-16
If the engine stalls while driving	6-2	Changing tires.....	6-17
If the engine stalls at a crossroad or crossing	6-3	Jack label.....	6-22
If you have a flat tire while driving.....	6-3	EC Declaration of conformity for Jack.....	6-23
If the engine will not start	6-4	Towing	6-24
If the engine doesn't turn over or turns		Towing service	6-24
over slowly.....	6-4	Removable towing hook	6-25
If the engine turns over normally but		Emergency towing	6-26
doesn't start	6-4	Emergency commodity.....	6-28
Jump starting	6-4	Fire extinguisher	6-28
If the engine overheats	6-8	First aid kit	6-28
Tire Pressure Monitoring System (TPMS).....	6-10	Triangle reflector	6-28
Check tire pressure	6-10	Tire pressure gauge	6-28
Tire Pressure Monitoring System.....	6-11		
Low tire pressure telltale	6-12		
Low tire pressure position and Tire pressure			
telltale	6-12		
TPMS (Tire Pressure Monitoring System)			
malfunction indicator	6-13		
Changing a tire with TPMS.....	6-14		

HAZARD WARNING FLASHER

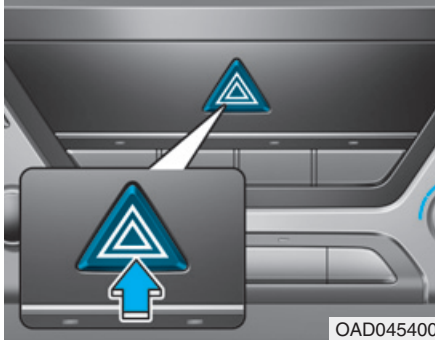

The hazard warning flasher serves as a warning to other drivers to exercise extreme caution when approaching, overtaking, or passing your vehicle.

It should be used whenever emergency repairs are being made or when the vehicle is stopped near the edge of a roadway.

To turn the hazard warning flasher on or off, press the hazard warning flasher/Stop button with the Engine Start/Stop button in any position. The button is located in the center fascia panel. All turn signal lights will flash simultaneously.

- The hazard warning flasher operates whether your vehicle is running or not.
- The turn signals do not work when the hazard flasher is on.

IN CASE OF AN EMERGENCY WHILE DRIVING

If the engine stalls while driving

- Reduce your speed gradually, keeping a straight line. Move cautiously off the road to a safe place.
- Turn on your hazard warning flasher.
- Try to start the engine again. If your vehicle will not start, we recommend that you contact an authorized HYUNDAI dealer.

If the engine stalls at a cross-road or crossing

If the engine stalls at a crossroad or crossing, if safe to do so, move the shift lever to the N (Neutral) position and then push the vehicle to a safe location.

If you have a flat tire while driving

If a tire goes flat while you are driving:

- Take your foot off the accelerator pedal and let the vehicle slow down while driving straight ahead. Do not apply the brakes immediately or attempt to pull off the road as this may cause loss of vehicle control resulting in an accident. When the vehicle has slowed to such a speed that it is safe to do so, brake carefully and pull off the road. Drive off the road as far as possible and park on firm, level ground. If you are on a divided highway, do not park in the median area between the two traffic lanes.

- When the vehicle is stopped, press the hazard warning flasher button, move the shift lever into P (Park, for automatic transmission/dual clutch transmission vehicle) or neutral (for manual transmission vehicle), apply the parking brake, and place the ignition switch in the LOCK/OFF position.
- Have all passengers get out of the vehicle. Be sure they all get out on the side of the vehicle that is away from traffic.
- When changing a flat tire, follow the instructions provided later in this chapter.

IF THE ENGINE WILL NOT START

If the engine doesn't turn over or turns over slowly

- Be sure the shift lever is in N (Neutral) or P (Park) if it is an automatic transmission vehicle. The engine starts only when the shift lever is in N (Neutral) or P (Park).
- Check the battery connections to be sure they are clean and tight.
- Turn on the interior light. If the light dims or goes out when you operate the starter, the battery is drained.

Do not push or pull the vehicle to start it. This could cause damage to your vehicle. **See instructions for "Jump Starting" provided in this chapter.**



CAUTION

Push or pull starting the vehicle may cause the catalytic converter to overload which can lead to damage to the emission control system.

JUMP STARTING

Jump starting can be dangerous if done incorrectly. Follow the jump starting procedure in this section to avoid serious injury or damage to your vehicle. If in doubt about how to properly jump start your vehicle, we strongly recommend that you have a service technician or towing service do it for you.

If the engine turns over normally but doesn't start

- Check the fuel level and add fuel if necessary.

If the engine still does not start, we recommend that you call an authorized HYUNDAI dealer for assistance.

WARNING

To prevent **SERIOUS INJURY** or **DEATH** to you or bystanders, always follow these precautions when working near or handling the battery:



Always read and follow instructions carefully when handling a battery.



Wear eye protection designed to protect the eyes from acid splashes.



Keep all flames, sparks, or smoking materials away from the battery.



Hydrogen is always present in battery cells, is highly combustible, and may explode if ignited.



Keep batteries out of reach of children.

(Continued)

(Continued)



Batteries contain sulfuric acid which is highly corrosive. Do not allow acid to contact your eyes, skin or clothing.

If acid gets into your eyes, flush your eyes with clean water for at least 15 minutes and get immediate medical attention. If acid gets on your skin, thoroughly wash the area. If you feel pain or a burning sensation, get medical attention immediately.

- When lifting a plastic-cased battery, excessive pressure on the case may cause battery acid to leak. Lift with a battery carrier or with your hands on opposite corners.
- Do not attempt to jump start your vehicle if your battery is frozen.

(Continued)

(Continued)

- **NEVER** attempt to recharge the battery when the vehicle's battery cables are connected to the battery.
- The electrical ignition system works with high voltage. **NEVER** touch these components with the engine running or when the Engine Start/Stop button is in the ON position.
- Do not allow the (+) and (-) jumper cables to touch. It may cause sparks.
- The battery may rupture or explode when you jump start with a low or frozen battery.

NOTICE

To prevent damage to your vehicle:

- Only use a 12-volt power supply (battery or jumper system) to jump start your vehicle.
- Do not attempt to jump start your vehicle by push-starting.

Information



An inappropriately disposed battery can be harmful to the environment and human health. Dispose the battery according to your local law(s) or regulations.

Jump starting procedure

1. Position the vehicles close enough that the jumper cables will reach, but do not allow the vehicles to touch.
2. Avoid fans or any moving parts in the engine compartment at all times, even when the vehicles are turned off.
3. Turn off all electrical devices such as radios, lights, air conditioning, etc. Put the vehicles in P (Park, for automatic transmission vehicle) or neutral (for manual transmission vehicle), and set the parking brakes. Turn both vehicles OFF.

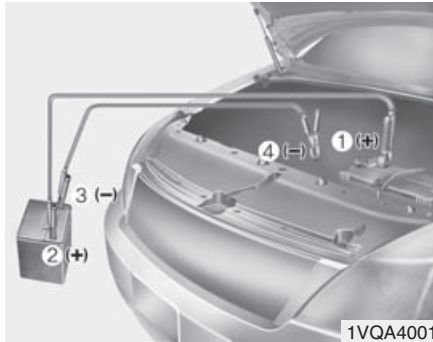

4. Connect the jumper cables in the exact sequence shown in the illustration. First connect one jumper cable to the red, positive (+) jumper terminal of your vehicle (1).
5. Connect the other end of the jumper cable to the red, positive (+) battery/jumper terminal of the assisting vehicle (2).
6. Connect the second jumper cable to the black, negative (-) battery/chassis ground of the assisting vehicle (3).

7. Connect the other end of the second jumper cable to the black, negative (-) chassis ground of your vehicle (4).

Do not allow the jumper cables to contact anything except the correct battery or jumper terminals or the correct ground. Do not lean over the battery when making connections.

8. Start the engine of the assisting vehicle and let it run at approximately 2,000 rpm for a few minutes. Then start your vehicle.

If your vehicle will not start after a few attempts, it probably requires servicing. In this event please seek qualified assistance. If the cause of your battery discharging is not apparent, have your vehicle checked by an authorized HYUNDAI dealer.

Disconnect the jumper cables in the exact reverse order you connected them:

1. Disconnect the jumper cable from the black, negative (-) chassis ground of your vehicle (4).
2. Disconnect the other end of the jumper cable from the black, negative (-) battery/chassis ground of the assisting vehicle (3).
3. Disconnect the second jumper cable from the red, positive (+) battery/jumper terminal of the assisting vehicle (2).
4. Disconnect the other end of the jumper cable from the red, positive (+) jumper terminal of your vehicle (1).

IF THE ENGINE OVERHEATS

If your temperature gauge indicates overheating, you experience a loss of power, or hear loud pinging or knocking, the engine may be overheating. If this happens, you should:

1. Pull off the road and stop as soon as it is safe to do so.
2. Place the shift lever in P (Park, for automatic transmission vehicle) or neutral (for manual transmission vehicle) and set the parking brake. If the air conditioning is ON, turn it OFF.
3. If engine coolant is running out under the vehicle or steam is coming out from the hood, stop the engine. Do not open the hood until the coolant has stopped running or the steaming has stopped. If there is no visible loss of engine coolant and no steam, leave the engine running and check to be sure the engine cooling fan is operating. If the fan is not running, turn the engine off.

⚠ WARNING

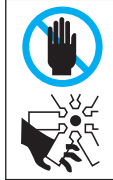

While the engine is running, keep hands, clothing and tools away from the moving parts such as the cooling fan and drive belt to prevent serious injury.

4. Check for coolant leaking from the radiator, hoses or under the vehicle. (If the air conditioning had been in use, it is normal for cold water to be draining from it when you stop.)
5. If engine coolant is leaking out, stop the engine immediately and we recommend that you call an authorized HYUNDAI dealer for assistance.

⚠ WARNING



NEVER remove the radiator cap or the drain plug while the engine and radiator are hot. Hot coolant and steam may blow out under pressure, causing serious injury. Turn the engine off and wait until the engine cools down. Use extreme care when removing the radiator cap. Wrap a thick towel around it, and turn it counterclockwise slowly to the first stop. Step back while the pressure is released from the cooling system. When you are sure all the pressure has been released, press down on the cap, using a thick towel, and continue turning counterclockwise to remove it.

6. If you cannot find the cause of the overheating, wait until the engine temperature has returned to normal. Then, if coolant has been lost, carefully add coolant to the reservoir to bring the fluid level in the reservoir up to the halfway mark.
7. Proceed with caution, keeping alert for further signs of overheating. If overheating happens again, we recommend that you call an authorized HYUNDAI dealer for assistance.

 **CAUTION**

- **Serious loss of coolant indicates a leak in the cooling system and we recommend the system be checked by an authorized HYUNDAI dealer.**
- **When the engine overheats from low engine coolant, suddenly adding engine coolant may cause cracks in the engine. To prevent damage, add engine coolant slowly in small quantities.**

TIRE PRESSURE MONITORING SYSTEM (TPMS) (IF EQUIPPED)

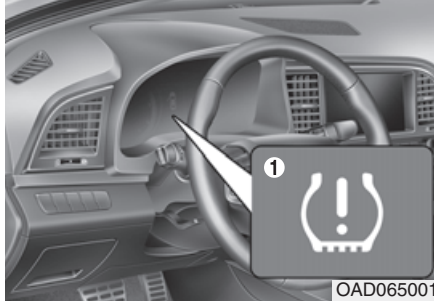

■ Supervision cluster

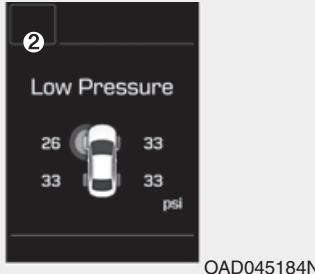

- (1) Low Tire Pressure Telltale/TPMS Malfunction Indicator
- (2) Low Tire Pressure Position Telltale and Tire Pressure Telltale (Shown on the LCD display)

Check tire pressure (if equipped)

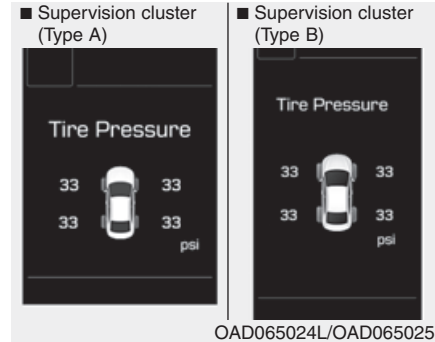

- You can check the tire pressure in the Information Mode on the cluster.

Refer to the "User Settings Mode" section in chapter 3.

- Tire pressure is displayed after a few minutes of driving after initial engine start up.
- If tire pressure is not displayed when the vehicle is stopped, "Drive to display" message will appear. After driving, check the tire pressure.

- The displayed tire pressure values may differ from those measured with a tire pressure gauge.
- You can change the tire pressure unit in the User Settings Mode on the cluster.
 - psi, kpa, bar (**Refer to the "User Settings Mode" section in chapter 3**).

Tire pressure monitoring system

WARNING

Over-inflation or under-inflation can reduce tire life, adversely affect vehicle handling, and lead to sudden tire failure that may cause loss of vehicle control resulting in an accident.

Each tire, including the spare (if provided), should be checked monthly when cold and inflated to the inflation pressure recommended by the vehicle manufacturer on the vehicle placard or tire inflation pressure label. (If your vehicle has tires of a different size than the size indicated on the vehicle placard or tire inflation pressure label, you should determine the proper tire inflation pressure for those tires.)

As an added safety feature, your vehicle has been equipped with a tire pressure monitoring system (TPMS) that illuminates a low tire pressure telltale when one or more of your tires is significantly under-inflated. Accordingly, when the low tire pressure telltale illuminates, you should stop and check your tires as soon as possible, and inflate them to the proper pressure. Driving on a significantly under-inflated tire causes the tire to overheat and can lead to tire failure.

Under-inflation also reduces fuel efficiency and tire tread life, and may affect the vehicle's handling and stopping ability.

Please note that the TPMS is not a substitute for proper tire maintenance, and it is the driver's responsibility to maintain correct tire pressure, even if under-inflation has not reached the level to trigger illumination of the TPMS low tire pressure telltale.

Your vehicle has also been equipped with a TPMS malfunction indicator to indicate when the system is not operating properly. The TPMS malfunction indicator is combined with the low tire pressure telltale. When the system detects a malfunction, the telltale will flash for approximately one minute and then remain continuously illuminated. This sequence will continue upon subsequent vehicle start-ups as long as the malfunction exists.

When the malfunction indicator is illuminated, the system may not be able to detect or signal low tire pressure as intended. TPMS malfunctions may occur for a variety of reasons, including the installation of replacement or alternate tires or wheels on the vehicle that prevent the TPMS from functioning properly.

Always check the TPMS malfunction telltale after replacing one or more tires or wheels on your vehicle to ensure that the replacement or alternate tires and wheels allow the TPMS to continue to function properly.

NOTICE

If any of the below happens, have the system checked by an authorized HYUNDAI dealer.

1. The Low Tire Pressure Telltale/TPMS Malfunction Indicator does not illuminate for 3 seconds when the ignition switch is placed to the ON position or engine is running.
2. The TPMS Malfunction Indicator remains illuminated after blinking for approximately 1 minute.
3. The Low Tire Pressure Position Telltale remains illuminated.



Low tire pressure telltale

Low tire pressure position and tire pressure telltale

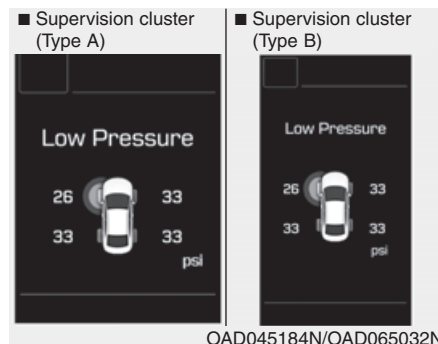

When the tire pressure monitoring system warning indicators are illuminated and warning message displayed on the cluster LCD display, one or more of your tires is significantly under-inflated. The Low Tire Pressure Position Telltale will indicate which tire is significantly under-inflated by illuminating the corresponding position light.

If either telltale illuminates, immediately reduce your speed, avoid hard cornering and anticipate increased stopping distances. You should stop and check your tires as soon as possible. Inflate the tires to the proper pressure as indicated on the vehicle's placard or tire inflation pressure label located on the driver's side center pillar outer panel.

If you cannot reach a service station or if the tire cannot hold the newly added air, replace the low pressure tire with the spare tire.

The Low Tire Pressure Telltale will remain on and the TPMS Malfunction Indicator may blink for one minute and then remain illuminated (when the vehicle is driven approximately 20 minutes at speed above 25 km/h (15.5 mph)) until you have the low pressure tire repaired and replaced on the vehicle.

i Information

The spare tire is not equipped with a tire pressure sensor.

 **CAUTION**

In winter or cold weather, the Low Tire Pressure Telltale may be illuminated if the tire pressure was adjusted to the recommended tire inflation pressure in warm weather. It does not mean your TPMS is malfunctioning because the decreased temperature leads to a proportional lowering of tire pressure.

When you drive your vehicle from a warm area to a cold area or from a cold area to a warm area, or the outside temperature is greatly higher or lower, you should check the tire inflation pressure and adjust the tires to the recommended tire inflation pressure.

 **WARNING**

Low pressure damage

Significantly low tire pressure makes the vehicle unstable and can contribute to loss of vehicle control and increased braking distances.

Continued driving on low pressure tires can cause the tires to overheat and fail.



TPMS (Tire Pressure Monitoring System) malfunction indicator

The TPMS Malfunction Indicator will illuminate after it blinks for approximately one minute when there is a problem with the Tire Pressure Monitoring System.

Have the system checked by an authorized HYUNDAI dealer as soon as possible.

NOTICE

If there is a malfunction with the TPMS, the Low Tire Pressure Position Telltale will not be displayed even though the vehicle has an under-inflated tire.

NOTICE

The TPMS Malfunction Indicator may illuminate after blinking for one minute if the vehicle is near electric power supply cables or radio transmitters such as police stations, government and public offices, broadcasting stations, military installations, airports, transmitting towers, etc.

Additionally, the TPMS Malfunction Indicator may illuminate if snow chains are used or electronic devices such as computers, chargers, remote starters, navigation, etc. This may interfere with normal operation of the TPMS.

Changing a tire with TPMS

If you have a flat tire, the Low Tire Pressure and Position telltales will come on. Have the flat tire repaired by an authorized HYUNDAI dealer as soon as possible or replace the flat tire with the spare tire.

CAUTION

Never use a puncture-repairing agent not approved by HYUNDAI dealer to repair and/or inflate a low pressure tire. Tire sealant not approved by HYUNDAI dealer may damage the tire pressure sensor.

The spare tire (if equipped) does not come with a tire pressure monitoring sensor. When the low pressure tire or the flat tire is replaced with the spare tire, the Low Tire Pressure Telltale will remain on. Also, the TPMS Malfunction Indicator will illuminate after blinking for one minute if the vehicle is driven at speed above 25 km/h (15.5 mph) for approximately 20 minutes.

Once the original tire equipped with a tire pressure monitoring sensor is reinflated to the recommended pressure and reinstalled on the vehicle, the Low Tire Pressure Telltale and TPMS Malfunction Indicator will go off within a few minutes of driving.

If the indicators do not extinguish after a few minutes, please visit an authorized HYUNDAI dealer.

Each wheel is equipped with a tire pressure sensor mounted inside the tire behind the valve stem (except for the spare tire). You must use TPMS specific wheels. It is recommended that you always have your tires serviced by an authorized HYUNDAI dealer.

You may not be able to identify a tire with low pressure by simply looking at it. Always use a good quality tire pressure gauge to measure. Please note that a tire that is hot (from being driven) will have a higher pressure measurement than a tire that is cold.

A cold tire means the vehicle has been sitting for 3 hours and driven for less than 1.6 km (1 mile) in that 3 hour period.

Allow the tire to cool before measuring the inflation pressure. Always be sure the tire is cold before inflating to the recommended pressure.

WARNING

- The TPMS cannot alert you to severe and sudden tire damage caused by external factors such as nails or road debris.
- If you feel any vehicle instability, immediately take your foot off the accelerator, apply the brakes gradually with light force, and slowly move to a safe position off the road.

WARNING

Tampering with, modifying, or disabling the Tire Pressure Monitoring System (TPMS) components may interfere with the system's ability to warn the driver of low tire pressure conditions and/or TPMS malfunctions. Tampering with, modifying, or disabling the Tire Pressure Monitoring System (TPMS) components may void the warranty for that portion of the vehicle.

WARNING

For EUROPE

- Do not modify the vehicle; it may interfere with the TPMS function.

- The wheels on the market do not have a TPMS sensor.

For your safety, we recommend that you use parts for replacement from an authorized HYUNDAI dealer.

- If you use the wheels on the market, use a TPMS sensor approved by a HYUNDAI dealer. If your vehicle is not equipped with a TPMS sensor or TPMS does not work properly, you may fail the periodic vehicle inspection conducted in your country.

***All vehicles sold in the EUROPE market during below period must be equipped with TPMS.**

- New model vehicle :
Nov. 1, 2012 ~

- Current model vehicle :
Nov. 1, 2014~ (Based on vehicle registrations)

IF YOU HAVE A FLAT TIRE

⚠ WARNING

Changing a tire can be dangerous. Follow the instructions in this section when changing a tire to reduce the risk of serious injury or death.

⚠ CAUTION

Be careful as you use the jack handle to stay clear of the flat end. The flat end has sharp edges that could cause cuts.

Jack and tools

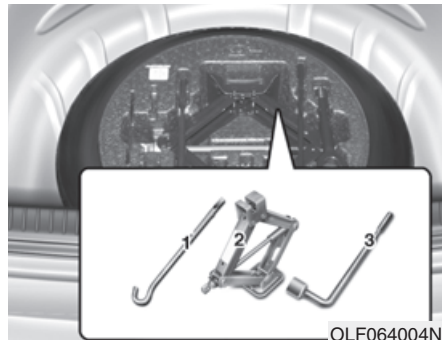

- (1) Jack handle
- (2) Jack
- (3) Wheel nut wrench

The jack, jack handle, and wheel lug nut wrench are stored in the luggage compartment under the luggage box cover.

The jack is provided for emergency tire changing only.

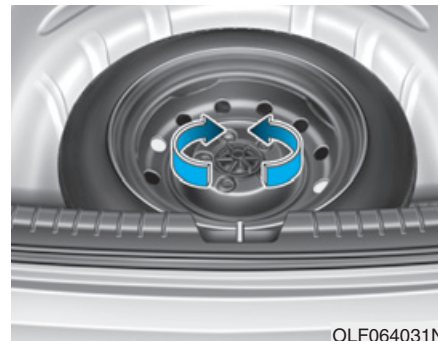

Turn the winged hold down bolt counterclockwise to remove the spare tire.

Store the spare tire in the same compartment by turning the winged hold down bolt clockwise.

To prevent the spare tire and tools from "rattling", store them in their proper location.



OLF064005

If it is hard to loosen the tire hold-down wing bolt by hand, you can loosen it easily using the jack handle.

1. Put the jack handle (1) inside of the tire hold-down wing bolt.
2. Turn the tire hold-down wing bolt counterclockwise with the jack handle.

Changing tires

WARNING

A vehicle can slip or roll off of a jack causing serious injury or death to you or those nearby. Take the following safety precautions:

- Do not get under a vehicle that is supported by a jack.
- **NEVER** attempt to change a tire in the lane of traffic. **ALWAYS** move the vehicle completely off the road on level, firm ground away from traffic before trying to change a tire. If you cannot find a level, firm place off the road, call a towing service for assistance.
- Be sure to use the jack provided with the vehicle.

(Continued)

(Continued)

- **ALWAYS** place the jack on the designated jacking positions on the vehicle and **NEVER** on the bumpers or any other part of the vehicle for jacking support.
- Do not start or run the engine while the vehicle is on the jack.
- Do not allow anyone to remain in the vehicle while it is on the jack.
- Keep children away from the road and the vehicle.

Follow these steps to change your vehicle's tire:

1. Park on a level, firm surface.
2. Move the shift lever into P (Park, for automatic transmission vehicle) or neutral (for manual transmission vehicle), apply the parking brake, and place the ignition switch in the LOCK/OFF position.
3. Press the hazard warning flasher button.
4. Remove the wheel lug nut wrench, jack, jack handle, and spare tire from the vehicle.

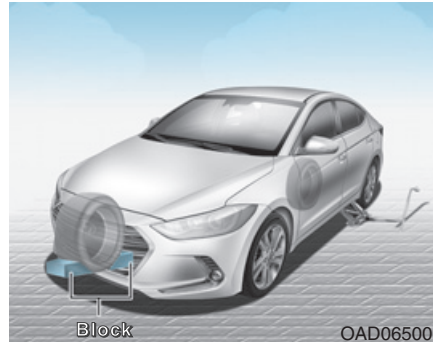

5. Block both the front and rear of the tire diagonally opposite of the tire you are changing.



6. Loosen the wheel lug nuts counterclockwise one turn each in the order shown above, but do not remove any lug nuts until the tire has been raised off of the ground.

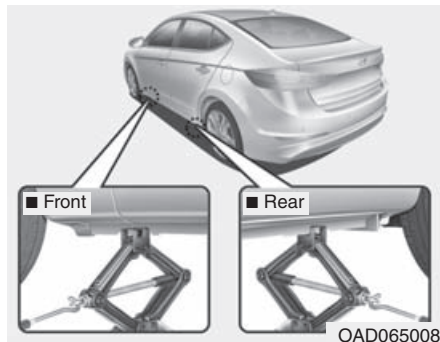

7. Place the jack at the designated jacking position under the frame closest to the tire you are changing. The jacking positions are plates welded to the frame with two notches and two dimples. Never jack any other position or part of the vehicle. It may damage to the side seal molding.



8. Insert the jack handle into the jack and turn it clockwise, raising the vehicle until the tire clears the ground. Make sure the vehicle is stable on the jack.
9. Loosen the lug nuts with the wheel lug nut wrench and remove them with your fingers. Remove the wheel from the studs and lay it flat on the ground out of the way. Remove any dirt or debris from the studs, mounting surfaces, and wheel.
10. Install the spare tire onto the studs of the hub.
11. Tighten the lug nuts with your fingers onto the studs with the smaller end of the lug nuts closest to the wheel.
12. Lower the vehicle to the ground by turning the jack handle counterclockwise.



13. Use the wheel lug nut wrench to tighten the lug nuts in the order shown. Double-check each lug nut until they are tight. After changing tires, we recommend that an authorized HYUNDAI dealer tighten the lug nuts to their proper torque as soon as possible. **The wheel lug nut should be tightened to 11~13 kgf.m (79~94 lbf.ft).**

If you have a tire gauge, check the tire pressure (see "Tires and Wheels" in chapter 8 for tire pressure instructions.). If the pressure is lower or higher than recommended, drive slowly to the nearest service station and adjust it to the recommended pressure. Always reinstall the valve cap after checking or adjusting tire pressure. If the cap is not replaced, air may leak from the tire. If you lose a valve cap, buy another and install it as soon as possible. After changing tires, secure the flat tire and return the jack and tools to their proper storage locations.

NOTICE

Check the tire pressure as soon as possible after installing a spare tire. Adjust it to the recommended pressure.

⚠ CAUTION

Your vehicle has metric threads on the studs and lug nuts. Make certain during tire changing that the same nuts that were removed are reinstalled. If you have to replace your lug nuts make sure they have metric threads to avoid damaging the studs and ensure the wheel is properly secured to the hub. We recommend that you consult an authorized HYUNDAI dealer for assistance.

If any of the equipment such as the jack, lug nuts, studs, or other equipment is damaged or in poor condition, do not attempt to change the tire and call for assistance.

Use of compact spare tires (if equipped)

Compact spare tires are designed for emergency use only. Drive carefully on the compact spare tire and always follow the safety precautions.

⚠ WARNING

To prevent compact spare tire failure and loss of control possibly resulting in an accident:

- **Use the compact spare tire only in an emergency.**
- **NEVER operate your vehicle over 80 km/h (50 mph).**
- **Do not exceed the vehicle's maximum load rating or the load carrying capacity shown on the sidewall of the compact spare tire.**
- **Do not use the compact spare tire continuously. Repair or replace the original tire as soon as possible to avoid failure of the compact spare tire.**

When driving with the compact spare tire mounted to your vehicle:

- Check the tire pressure after installing the compact spare tire. The compact spare tire should be inflated to 420 kPa (60 psi).
- Do not take this vehicle through an automatic car wash while the compact spare tire is installed.
- Do not use the compact spare tire on any other vehicle because this tire has been designed especially for your vehicle.
- The compact spare tire's tread life is shorter than a regular tire. Inspect your compact spare tire regularly and replace worn compact spare tires with the same size and design, mounted on the same wheel.
- Do not use more than one compact spare tire at a time.
- Do not tow a trailer while the compact spare tire is installed.

NOTICE

When the original tire and wheel are repaired and reinstalled on the vehicle, the lug nut torque must be set correctly. The correct lug nut tightening torque is 11~13 kgf.m (79~94 lbf.ft).

CAUTION

To prevent damaging the compact spare tire and your vehicle:

- Drive slowly enough for the road conditions to avoid all hazards, such as a potholes or debris.
- Avoid driving over obstacles. The compact spare tire diameter is smaller than the diameter of a conventional tire and reduces the ground clearance approximately 25 mm (1 inch).
- Do not use tire chains on the compact spare tire. Because of the smaller size, a tire chain will not fit properly.
- Do not use the compact spare tire on any other wheels, nor should standard tires, snow tires, wheel covers or trim rings be used with the compact spare wheel.

Jack label

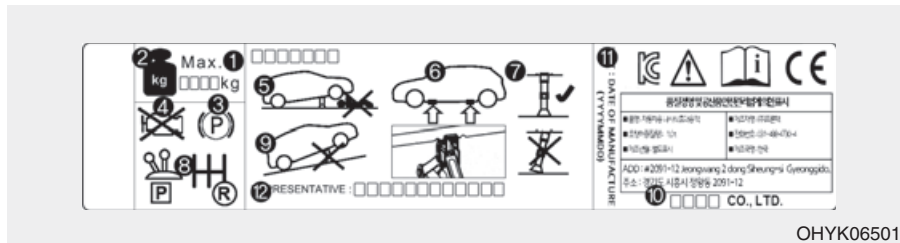

The actual Jack label in the vehicle may differ from the illustration. For more detailed specifications, refer to the label attached to the jack.

1. Model Name
2. Maximum allowable load
3. When using the jack, set your parking brake.
4. When using the jack, stop the engine.
5. Do not get under a vehicle that is supported by a jack.
6. The designated locations under the frame
7. When supporting the vehicle, the base plate of jack must be vertical under the lifting point.
8. Shift into Reverse gear on vehicles with manual transmission or move the shift lever to the P position on vehicles with automatic transmission/dual clutch transmission.
9. The jack should be used on firm level ground.
10. Jack manufacture
11. Production date
12. Representative company and address

EC Declaration of conformity for Jack

CE	
EC Declaration of Conformity according to EC Machinery Directive 2006/42/EC	
We, SAMKI IND. CO., LTD. # 22, Hyojuk3-Gil, Buk-Gu, Ulsan, Korea declare under our sole responsibility that the product	
Product	: Jack Assembly
Type Designation(s)	: Jack Assembly-600kg, Jack Assembly-700kg Jack Assembly-800kg, Jack Assembly-1000kg Jack Assembly-1200kg, Jack Assembly-1500kg
Serial No.	: N/A
Year of Manufacture	: 2013
to which this declaration relates is in conformity with the following standard(s) or other normative document(s):	
EN ISO12100 (2010)	Safety of machinery - General principles for design – Risk assessment and risk reduction
EN ISO12100-2/A1 (2009)	Safety of machinery - Basic concepts, general principles for design, Part 2 : Technical principles
EN 1494/A1 (2008)	Mobile or movable jacks and associated lifting equipment
following the provisions of Directive(s):	
2006/42/EC	Directive on the approximation of the laws of Member States relating to machinery (OJ L157 Jun. 9, 2006)
Ulsan, Korea / Jul. 25, 2013 Hyun Duck, Cho President 	
(Place and date of issue)(name and signature or equivalent making of authorized person)	
* T.C.F Compiling Person: <u>Safemot Limited (European Notified body : 1674)</u> <u>Denford Garage, Denford, Kettering Northants, NN14 4EQ, England</u>	

JACKDOC14S

TOWING

Towing service

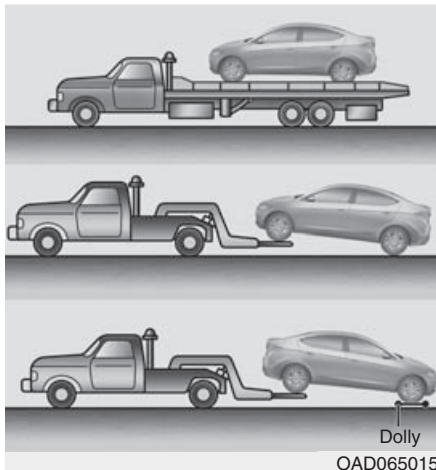

If emergency towing is necessary, we recommend having it done by an authorized HYUNDAI dealer or a commercial tow-truck service.

Proper lifting and towing procedures are necessary to prevent damage to the vehicle. The use of wheel dollies or flatbed is recommended.

It is acceptable to tow the vehicle with the rear wheels on the ground (without dollies) and the front wheels off the ground.

If any of the loaded wheels or suspension components are damaged or the vehicle is being towed with the front wheels on the ground, use a towing dolly under the front wheels.

When being towed by a commercial tow truck and wheel dollies are not used, the front of the vehicle should always be lifted, not the rear.

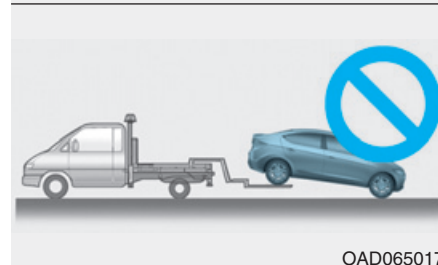

CAUTION

- Do not tow the vehicle with the front wheels on the ground as this may cause damage to the vehicle.
- Do not tow with sling-type equipment. Use wheel lift or flatbed equipment.

When towing your vehicle in an emergency without wheel dollies:

1. Place the ignition switch in the ACC position.
2. Place the shift lever in N (Neutral).
3. Release the parking brake.



CAUTION

Failure to place the shift lever in N (Neutral) may cause internal damage to the transmission.

Removable towing hook



1. Open the trunk, and remove the towing hook from the tool case.

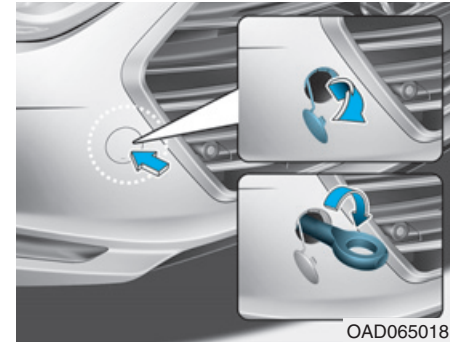

2. Remove the hole cover pressing the lower part of the cover on the front bumper.
3. Install the towing hook by turning it clockwise into the hole until it is fully secured.
4. Remove the towing hook and install the cover after use.

Emergency towing

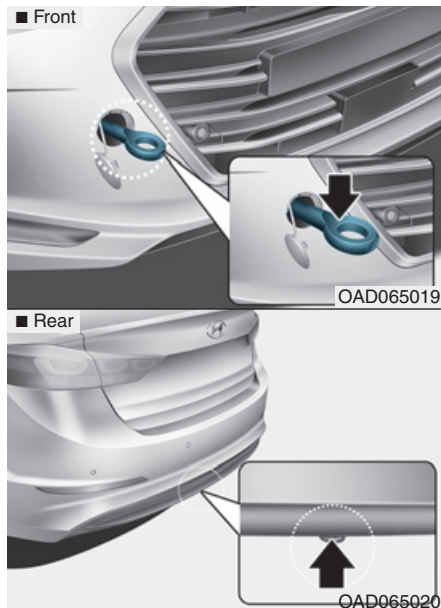

If towing is necessary, we recommend you have it done by an authorized HYUNDAI dealer or a commercial tow truck service.

If towing service is not available in an emergency, your vehicle may be temporarily towed using a cable or chain secured to the emergency towing hook at the front (or rear) of the vehicle.

Use extreme caution when towing the vehicle with a cable or chain. A driver must be in the vehicle to steer it and operate the brakes.

Towing in this manner may be done only on hard-surfaced roads for a short distance and at low speeds. Also, the wheels, axles, power train, steering and brakes must all be in good condition.

Always follow these emergency towing precautions:

- Place the ignition switch in the ACC position so the steering wheel is not locked.
- Place the shift lever in N (Neutral).
- Release the parking brake.
- Depress the brake pedal with more force than normal since you will have reduced braking performance.
- More steering effort will be required because the power steering system will be disabled.
- Use a vehicle heavier than your own to tow your vehicle.
- The drivers of both vehicles should communicate with each other frequently.
- Before emergency towing, check that the hook is not broken or damaged.
- Fasten the towing cable or chain securely to the hook.
- Do not jerk the hook. Apply steady and even force.

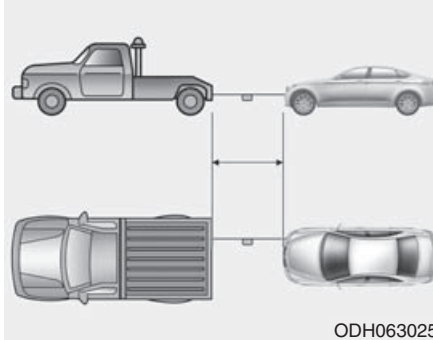

ODH063025

- Use a towing cable or chain less than 5 m (16 feet) long. Attach a white or red cloth (about 30 cm (12 inches) wide) in the middle of the cable or chain for easy visibility.
- Drive carefully so the towing cable or chain remains tight during towing.
- Before towing, check the automatic transmission/dual clutch transmission for fluid leaks under your vehicle. If the automatic transmission/dual clutch transmission fluid is leaking, flatbed equipment or a towing dolly must be used.

CAUTION

To avoid damage to your vehicle and vehicle components when towing:

- Always pull straight ahead when using the towing hooks. Do not pull from the side or at a vertical angle.
- Do not use the towing hooks to pull a vehicle out of mud, sand or other conditions from which the vehicle cannot be driven out under its own power.
- Limit the vehicle speed to 15 km/h (10 mph) and drive less than 1.5 km (1 mile) when towing to avoid serious damage to the automatic transmission/dual clutch transmission.

EMERGENCY COMMODITY (IF EQUIPPED)

Your vehicle is equipped with emergency commodities to help you respond to emergency situation.

Fire extinguisher

If there is small fire and you know how to use the fire extinguisher, follow these steps carefully.

1. Pull out the safety pin at the top of the extinguisher that keeps the handle from being accidentally pressed.
2. Aim the nozzle towards the base of the fire.
3. Stand approximately 2.5 m (8 ft) away from the fire and squeeze the handle to discharge the extinguisher. If you release the handle, the discharge will stop.
4. Sweep the nozzle back and forth at the base of the fire. After the fire appears to be out, watch carefully since it may re-ignite.

First aid kit

Supplies for use in giving first aid such as scissors, bandage and adhesive tape, etc. are provided.

Triangle reflector

Place the triangle reflector on the road to warn oncoming vehicles during emergencies, such as when the vehicle is parked by the roadside due to problems.

Tire pressure gauge (if equipped)

Tires normally lose some air in day-to-day use, and you may have to add a air periodically and usually it is not a sign of a leaking tire, but of normal wear. Always check tire pressure when the tires are cold because tire pressure increases with temperature.

To check the tire pressure, take the following steps:

1. Unscrew the inflation valve cap that is located on the rim of the tire.
2. Press and hold the gauge against the tire valve. Some air will leak as you begin and more will leak if you don't press the gauge in firmly.
3. A firm non-leaking push will activate the gauge.
4. Read the tire pressure on the gauge to see whether the tire pressure is low or high.
5. Adjust the tire pressure to the specified pressure. Refer to "Tires and Wheels" in chapter 8.
6. Reinstall the inflation valve cap.

Maintenance

Engine compartment	7-3
Maintenance services	7-6
Owner's responsibility	7-6
Owner maintenance precautions	7-6
Owner maintenance	7-7
Owner maintenance schedule	7-8
Scheduled maintenance services	7-10
Normal maintenance schedule	
- Gasoline engine (For Europe)	7-11
Maintenance under severe usage and low mileage conditions - Gasoline engine (For Europe)	7-14
Normal maintenance schedule	
- Gasoline engine (Except Europe)	7-16
Maintenance under severe usage and low mileage conditions - Gasoline engine (Except Europe)	7-20
Normal maintenance schedule - Diesel engine	7-22
Maintenance under severe usage and low mileage conditions - Diesel engine	7-26
Explanation of scheduled maintenance items ..	7-28
Engine oil	7-32
Checking the engine oil level	7-32
Checking the engine oil and filter	7-34
Engine coolant	7-35
Checking the engine coolant level	7-35
Changing the coolant	7-37
Brake/clutch fluid	7-38
Checking the brake/clutch fluid level	7-38
Washer fluid	7-40
Checking the washer fluid level	7-40
Parking brake	7-41
Checking the parking brake	7-41
Fuel filter (for Diesel)	7-41
Draining water from fuel filter	7-41
Air cleaner	7-42
Filter replacement	7-42
Climate control air filter	7-44
Filter inspection	7-44
Filter replacement	7-44
Wiper blades	7-45
Blade inspection	7-45
Blade replacement	7-45
Battery	7-48
For best battery service	7-48
Battery capacity label	7-50
Battery recharging	7-50
Reset items	7-51

Tires and wheels	7-52	Appearance care	7-103
Tire care	7-52	Exterior care	7-103
Recommended cold tire inflation pressures	7-52	Interior care	7-109
Checking tire inflation pressure	7-54	Emission control system	7-111
Tire rotation	7-55	Crankcase emission control system	7-111
Wheel alignment and tire balance	7-56	Evaporative emission control system	7-111
Tire replacement	7-56	Exhaust emission control system	7-112
Wheel replacement	7-58		
Tire traction	7-58		
Tire maintenance	7-58		
Tire sidewall labeling	7-58		
Low aspect ratio tire	7-63		
Fuses	7-64		
Fuse/Relay panel description	7-70		
Light bulbs	7-84		
Headlamp, position lamp, turn signal lamp and fog lamp light bulb replacement	7-85		
Side repeater lamp replacement	7-91		
Headlamp and front fog lamp aiming (for Europe)	7-92		
Rear combination lamp bulb replacement	7-97		
High mounted stop lamp replacement	7-101		
License plate light bulb replacement	7-101		
Interior light bulb replacement	7-102		

ENGINE COMPARTMENT

■ Gasoline Engine (Nu 2.0 MPI)

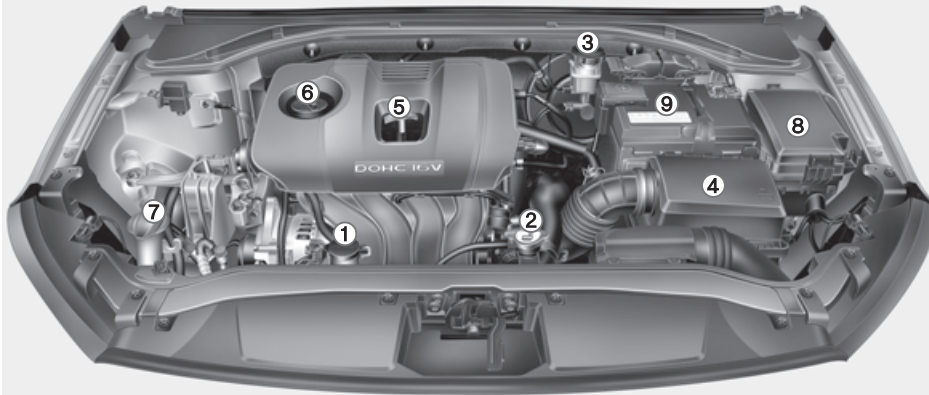

1. Engine coolant reservoir
2. Radiator cap
3. Brake/clutch fluid reservoir
4. Air cleaner
5. Engine oil dipstick
6. Engine oil filler cap
7. Windshield washer fluid reservoir
8. Fuse box
9. Battery

The actual engine room in the vehicle may differ from the illustration.

OAD075100L

■ Gasoline Engine (Gamma 1.6 MPI)

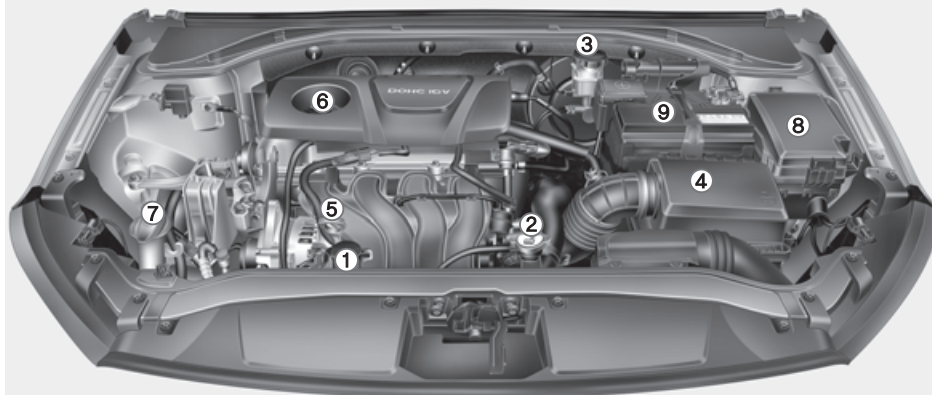

1. Engine coolant reservoir
2. Radiator cap
3. Brake/clutch fluid reservoir
4. Air cleaner
5. Engine oil dipstick
6. Engine oil filler cap
7. Windshield washer fluid reservoir
8. Fuse box
9. Battery

The actual engine room in the vehicle may differ from the illustration.

OAD075101L

■ Diesel Engine (UII 1.6 TCI)

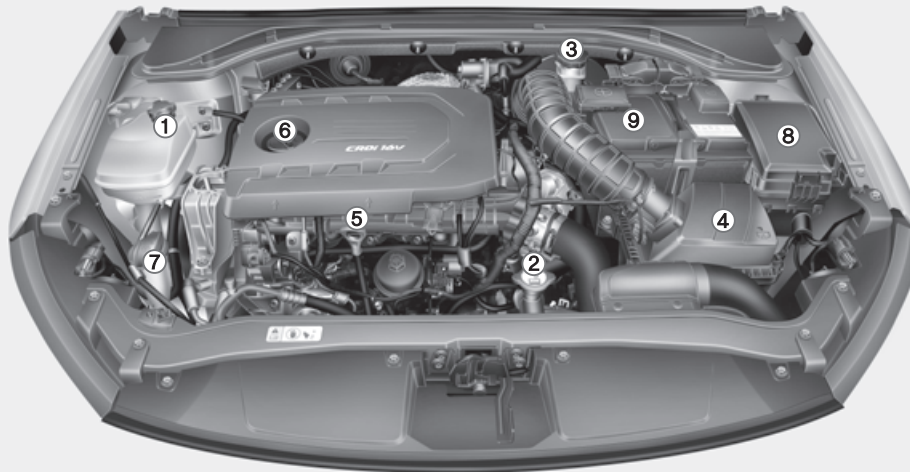

1. Engine coolant reservoir
2. Radiator cap
3. Brake/clutch fluid reservoir
4. Air cleaner
5. Engine oil dipstick
6. Engine oil filler cap
7. Windshield washer fluid reservoir
8. Fuse box
9. Battery

The actual engine room in the vehicle may differ from the illustration.

OAD075001

MAINTENANCE SERVICES

You should exercise the utmost care to prevent damage to your vehicle and injury to yourself whenever performing any maintenance or inspection procedures.

We recommend you have your vehicle maintained and repaired by an authorized HYUNDAI dealer. An authorized HYUNDAI dealer meets HYUNDAI's high service quality standards and receives technical support from HYUNDAI in order to provide you with a high level of service satisfaction.

Owner's responsibility

Maintenance service and record retention are the owner's responsibility.

You should retain documents that show proper maintenance has been performed on your vehicle in accordance with the scheduled maintenance service charts shown on the following pages. You need this information to establish your compliance with the servicing and maintenance requirements of your vehicle warranties.

Detailed warranty information is provided in your Service Passport.

Repairs and adjustments required as a result of improper maintenance or a lack of required maintenance are not covered.

Owner maintenance precautions

Inadequate, incomplete or insufficient servicing may result in operational problems with your vehicle that could lead to vehicle damage, an accident, or personal injury. This chapter provides instructions only for the maintenance items that are easy to perform. Several procedures can be done only by an authorized HYUNDAI dealer with special tools.

Your vehicle should not be modified in any way. Such modifications may adversely affect the performance, safety or durability of your vehicle and may, in addition, violate conditions of the limited warranties covering the vehicle.

NOTICE

Improper owner maintenance during the warranty period may affect warranty coverage. For details, read the separate Service Passport provided with the vehicle. If you're unsure about any servicing or maintenance procedure, we recommend that the system be serviced by an authorized HYUNDAI dealer.

OWNER MAINTENANCE

WARNING

Performing maintenance work on a vehicle can be dangerous. If you lack sufficient knowledge and experience or the proper tools and equipment to do the work, we recommend that the system be serviced by an authorized HYUNDAI dealer. ALWAYS follow these precautions for performing maintenance work:

- Park your vehicle on level ground, move the shift lever into the P (Park, for automatic transmission vehicle) position, apply the parking brake, place the ignition switch in the LOCK/OFF position.

(Continued)

(Continued)

- Block the tires (front and back) to prevent the vehicle from moving.

Remove loose clothing or jewelry that can become entangled in moving parts.

- If you must run the engine during maintenance, do so out doors or in an area with plenty of ventilation.
- Keep flames, sparks, or smoking materials away from the battery and fuel-related parts.

The following lists are vehicle checks and inspections that should be performed by the owner or an authorized HYUNDAI dealer at the frequencies indicated to help ensure safe, dependable operation of your vehicle.

Any adverse conditions should be brought to the attention of your dealer as soon as possible.

These Owner Maintenance vehicle checks are generally not covered by warranties and you may be charged for labor, parts and lubricants used.

 **WARNING**

Diesel Engine

Never manipulate or modify the injection system while running the diesel engine or within 30 seconds after turning OFF the diesel engine. The high-pressure pump, high-pressure pipes, rail, and injectors are still subject to the high pressure right after stopping the diesel engine. When the fuel leakage vents out, it may cause serious body injury. Any people, who are implemented with the artificial cardiac pacemaker, should remain away from the ECU or the wiring harness by at least 30 cm, while running the diesel engine. The high currents of the electric engine control system produce a considerable amount of magnetic fields.

Owner maintenance schedule

When you stop for fuel:

- Check the engine oil level.
- Check coolant level in the engine coolant reservoir.
- Check the windshield washer fluid level.
- Check for low or under-inflated tires.

 **WARNING**

Be careful when checking your engine coolant level when the engine is hot. This may result in coolant being blown out of the opening and cause serious burns and other injuries.

While operating your vehicle:

- Note any changes in the sound of the exhaust or any smell of exhaust fumes in the vehicle.
- Check for vibrations in the steering wheel. Notice if there is any increased steering effort or looseness in the steering wheel, or change in its straight-ahead position.
- Notice if your vehicle constantly turns slightly or “pulls” to one side when traveling on smooth, level road.
- When stopping, listen and check for unusual sounds, pulling to one side, increased brake pedal travel or “hard-to-push” brake pedal.
- If any slipping or changes in the operation of your transmission occurs, check the transmission fluid level.
- Check the automatic transmission P (Park) function.
- Check the parking brake.
- Check for fluid leaks under your vehicle (water dripping from the air conditioning system during or after use is normal).

At least monthly:

- Check coolant level in the engine coolant reservoir.
- Check the operation of all exterior lights, including the stoplights, turn signals and hazard warning flashers.
- Check the inflation pressures of all tires including the spare for tires that are worn, show uneven wear, or are damaged.
- Check for loose wheel lug nuts.

***At least twice a year:
(i.e., every Spring and Fall)***

- Check radiator, heater and air conditioning hoses for leaks or damage.
- Check windshield washer spray and wiper operation. Clean wiper blades with clean cloth dampened with washer fluid.
- Check headlamp alignment.
- Check muffler, exhaust pipes, shields and clamps.
- Check the seat belts for wear and function.

At least once a year:

- Clean body and door drain holes.
- Lubricate door hinges and hood hinges.
- Lubricate door and hood locks and latches.
- Lubricate door rubber weather strips.
- Lubricate door checker
- Check the air conditioning system.
- Inspect and lubricate automatic transmission linkage and controls.
- Clean the battery and terminals.
- Check the brake fluid level.

SCHEDULED MAINTENANCE SERVICES

Follow Normal Maintenance Schedule if the vehicle is usually operated where none of the following conditions apply. If any of the following conditions apply, you must follow the Maintenance Under Severe Usage Conditions.

- Repeated driving short distance of less than 8 km (5 miles) in normal temperature or less than 16 km(10 miles) in freezing temperature
- Extensive engine idling or low speed driving for long distances
- Driving on rough, dusty, muddy, unpaved, graveled or salt-spread roads
- Driving in areas using salt or other corrosive materials or in very cold weather
- Driving in the condition of inflowing sand or dust into engine
- Driving in heavy traffic area
- Driving on uphill, downhill, or mountain road repeatedly
- Towing a trailer or using a camper, or roof rack
- Driving as a patrol car, taxi, other commercial use of vehicle towing
- Driving over 170 km/h (106 mile/h)
- Frequently driving in stop-and-go condition

If your vehicle is operated under the above conditions, you should inspect, replace or refill more frequently than the following Normal Maintenance Schedule. After the periods or distance shown in the chart, continue to follow the prescribed maintenance intervals.

Normal Maintenance Schedule – Gasoline Engine (For Europe)

MAINTENANCE ITEM	MAINTENANCE INTERVALS	Number of months or driving distance, whichever comes first							
	Months	12	24	36	48	60	72	84	96
	Miles×1,000	10	20	30	40	50	60	70	80
	Km×1,000	15	30	45	60	75	90	105	120
Drive belts *1	At first, inspect at 90,000 km (60,000 miles) or 72 months after that, inspect every 30,000 km (20,000 miles) or 24 months								
Engine oil and engine oil filter *2	R	R	R	R	R	R	R	R	R
Air cleaner filter	I	I	R	I	I	R	I	I	
Spark plugs *3	Replace every 165,000 km (102,500 miles)								
Valve clearance (For Gamma 1.6) *4						I			
Vapor hose and fuel filler cap				I					I
Fuel tank air filter (if equipped)				I					I
Vacuum hose	I	I	I	I	I	I	I	I	I

I : Inspect and if necessary, adjust, correct, clean or replace.

R : Replace or change.

*1 : Adjust alternator and power steering (and water pump drive belt) and air conditioner drive belt (if equipped).
Inspect and if necessary correct or replace.

*2 : Check the engine oil level and leak every 500 km (350 miles) or before starting a long trip.

*3 : For your convenience, it can be replaced prior to it's interval when you do maintenance of other items.

*4 : Inspect for excessive valve noise and/or engine vibration and adjust if necessary. We recommend that the system be checked by an authorized HYUNDAI dealer.

Normal Maintenance Schedule (Cont.) – Gasoline Engine (For Europe)

MAINTENANCE ITEM	MAINTENANCE INTERVALS	Number of months or driving distance, whichever comes first								
		Months	12	24	36	48	60	72	84	96
		Miles×1,000	10	20	30	40	50	60	70	80
		Km×1,000	15	30	45	60	75	90	105	120
Fuel filter * ⁵										
Fuel lines, hoses and connections										
Cooling system	Inspect “Coolant level adjustment and leak” every day									
	At first, inspect at 60,000 km (40,000 miles) or 48 months after that, inspect every 30,000 km (20,000 miles) or 24 months									
Engine coolant * ⁶	At first, replace at 210,000 km (120,000 miles) or 10 years: after that, replace every 30,000 km (20,000 miles) or 24 months * ⁷									
Battery condition										
Brake lines, hoses and connections										
Brake pedal, Clutch pedal (if equipped)										
Parking brake										

I : Inspect and if necessary, adjust, correct, clean or replace.

R : Replace or change.

*⁵ : The fuel filter is considered to be maintenance free but periodic inspection is recommended for this maintenance schedule depends on fuel quality. If there are some important matters like fuel flow restriction, surging, loss of power, hard starting problem etc, we recommend replacing the fuel filter immediately regardless of maintenance schedule and consulting with an authorized HYUNDAI dealer for details.

*⁶ : When adding coolant, use only deionized water or soft water for your vehicle and never mix hard water in the coolant filled at the factory. An improper coolant mixture can result in serious malfunction or engine damage.

*⁷ : For your convenience, it can be replaced prior to it's interval when you do maintenance of other items.

Normal Maintenance Schedule (Cont.) – Gasoline Engine (For Europe)

MAINTENANCE ITEM	MAINTENANCE INTERVALS	Number of months or driving distance, whichever comes first								
		Months	12	24	36	48	60	72	84	96
		Miles×1,000	10	20	30	40	50	60	70	80
		Km×1,000	15	30	45	60	75	90	105	120
Brake/clutch fluid		I	I	I	I	I	I	I	I	
Disc brakes and pads		I	I	I	I	I	I	I	I	
Steering gear rack, linkage and boots		I	I	I	I	I	I	I	I	
Driveshaft and boots			I		I		I		I	
Tire (pressure & tread wear)		I	I	I	I	I	I	I	I	
Front suspension ball joints		I	I	I	I	I	I	I	I	
Bolt and nuts on chassis and body		I	I	I	I	I	I	I	I	
Air conditioner refrigerant (if equipped)		I	I	I	I	I	I	I	I	
Air conditioner compressor (if equipped)		I	I	I	I	I	I	I	I	
Climate control air filter (if equipped)			R		R		R		R	
Manual transmission fluid (if equipped) * ⁸					I				I	
Automatic transmission fluid (if equipped)		No check, No service required								
Exhaust system			I		I		I		I	

I : Inspect and if necessary, adjust, correct, clean or replace.

R : Replace or change.

*⁸ : Manual transmission fluid should be changed anytime they have been submerged in water.

Maintenance Under Severe Usage and Low Mileage Conditions – Gasoline Engine (For Europe)

The following items must be serviced more frequently on cars mainly used under severe and low mileage driving conditions.

Refer to the chart below for the appropriate maintenance intervals.

R : Replace I : Inspect and if necessary, adjust, correct, clean or replace

Maintenance item	Maintenance operation	Maintenance intervals	Driving condition
Engine oil and engine oil filter	R	Every 7,500 km (4,650 miles) or 6 months	A, B, C, D, E, F, G, H, I, J, K
Air cleaner filter	R	Replace more frequently depending on the condition	C, E
Spark plugs	R	Replace more frequently depending on the condition	A, B, H, I
Steering gear rack, linkage and boots	I	Inspect more frequently depending on the condition	C, D, E, F, G
Front suspension ball joints	I	Inspect more frequently depending on the condition	C, D, E, F, G
Disc brakes and pads, calipers and rotors	I	Inspect more frequently depending on the condition	C, D, E, G, H
Parking brake	I	Inspect more frequently depending on the condition	C, D, G, H

Maintenance item	Maintenance operation	Maintenance intervals	Driving condition
Driveshaft and boots	I	Inspect more frequently depending on the condition	C, D, E, F, G, H, I
Manual transmission fluid (if equipped)	R	Every 120,000 km (80,000 miles)	C, F, G, I, K
Automatic transmission fluid (if equipped)	R	Every 90,000 km (60,000 miles)	A, C, F, G, I
Climate control air filter (if equipped)	R	Replace more frequently depending on the condition	C, E

Severe driving conditions

- A : Repeatedly driving short distance of less than 8 km (5 miles) in normal temperature or less than 16 km (10 miles) in freezing temperature
- B : Extensive engine idling or low speed driving for long distances
- C : Driving on rough, dusty, muddy, unpaved, graveled or salt spread roads
- D : Driving in areas using salt or other corrosive materials or in very cold weather

- E : Driving in the condition of inflowing sand or dust into engine
- F : Driving in heavy traffic area
- G : Driving on uphill, downhill, or mountain roads repeatedly
- H : Towing a trailer, or using a camper or roof rack
- I : Driving for patrol car, taxi, commercial car or vehicle towing
- J : Driving over 140 km/h (87 mile/h)
- K : Driving over 170 km/h (106 mile/h)
- L : Frequently driving in stop-and-go conditions and under 15,000 km per year.

Normal Maintenance Schedule – Gasoline Engine (Except Europe)

MAINTENANCE ITEM	MAINTENANCE INTERVALS	Number of months or driving distance, whichever comes first								
	Months	12	24	36	48	60	72	84	96	
	Miles×1,000	10	20	30	40	50	60	70	80	
	Km×1,000	15	30	45	60	75	90	105	120	
Drive belts *1			I		I		I		I	
Engine oil and engine oil filter *2	For Middle East *3, Central & South America	Replace every 10,000 km (6,200 miles) or 12 months								
	Except Middle East *3, Central & South America	R	R	R	R	R	R	R	R	
Air cleaner filter	For Middle East *3	R	R	R	R	R	R	R	R	
	Except Middle East *3	I	I	R	I	I	R	I	I	
Fuel additives *4		Add every 10,000 km (6,500 miles) or 6 months								

I : Inspect and if necessary, adjust, correct, clean or replace.

R : Replace or change.

*1 : Adjust alternator and power steering (and water pump drive belt) and air conditioner drive belt (if equipped).
Inspect and if necessary correct or replace.

*2 : Check the engine oil level and leak every 500 km (350 miles) or before starting a long trip.

*3 : Middle East includes Morocco, Sudan and Egypt.

*4 : If good quality gasolines meet Europe Fuel standards (EN228) or equivalents including fuel additives is not available, one bottle of additive is recommended. Additives are available from your authorized HYUNDAI dealer along with information on how to use them.
Do not mix other additives.

Normal Maintenance Schedule (Cont.) – Gasoline Engine (Except Europe)

MAINTENANCE ITEM	MAINTENANCE INTERVALS	Number of months or driving distance, whichever comes first								
		Months	12	24	36	48	60	72	84	96
		Miles×1,000	10	20	30	40	50	60	70	80
		Km×1,000	15	30	45	60	75	90	105	120
Spark plugs ^{*5}		Replace every 165,000 km (102,500 miles)								
Valve clearance ^{*6} (For Gamma 1.6)							I			
Vapor hose and fuel filler cap					I				I	
Fuel tank air filter (if equipped)			I		R		I		R	
Vacuum hose		I	I	I	I	I	I	I	I	
Fuel filter ^{*7}			I		R		I		R	
Fuel lines, hoses and connections					I				I	

I : Inspect and if necessary, adjust, correct, clean or replace.

R : Replace or change.

^{*5} : For your convenience, it can be replaced prior to it's interval when you do maintenance of other items.

^{*6} : Inspect for excessive valve noise and/or engine vibration and adjust if necessary. We recommend that the system be checked by an authorized HYUNDAI dealer.

^{*7} : The fuel filter is considered to be maintenance free but periodic inspection is recommended for this maintenance schedule depends on fuel quality. If there are some important matters like fuel flow restriction, surging, loss of power, hard starting problem etc, we recommend replacing the fuel filter immediately regardless of maintenance schedule and consulting with an authorized HYUNDAI dealer for details.

Normal Maintenance Schedule (Cont.) – Gasoline Engine (Except Europe)

MAINTENANCE ITEM	MAINTENANCE INTERVALS	Number of months or driving distance, whichever comes first								
		Months	12	24	36	48	60	72	84	96
		Miles×1,000	10	20	30	40	50	60	70	80
		Km×1,000	15	30	45	60	75	90	105	120
Cooling system		Inspect "Coolant level adjustment and leak" every day At first, inspect 60,000 km (40,000 miles) or 48 months after that, inspect every 30,000 km (20,000 miles) or 24 months								
Engine coolant * ⁸		At first replace at 200,000 km (120,000 miles) or 10 years: after that, replace every 40,000 km (25,000 miles) or 24 months * ⁹								
Battery condition		I	I	I	I	I	I	I	I	
Brake lines, hoses and connections		I	I	I	I	I	I	I	I	
Brake pedal, Clutch pedal (if equipped)			I		I		I		I	
Parking brake			I		I		I		I	
Brake/clutch fluid		I	I	I	I	I	I	I	I	
Disc brakes and pads		I	I	I	I	I	I	I	I	

I : Inspect and if necessary, adjust, correct, clean or replace.

R : Replace or change.

*⁸ : When adding coolant, use only deionized water or soft water for your vehicle and never mix hard water in the coolant filled at the factory.

An improper coolant mixture can result in serious malfunction or engine damage.

*⁹ : For your convenience, it can be replaced prior to it's interval when you do maintenance of other items.

Normal Maintenance Schedule (Cont.) – Gasoline Engine (Except Europe)

MAINTENANCE INTERVALS MAINTENANCE ITEM	Number of months or driving distance, whichever comes first								
	Months	12	24	36	48	60	72	84	96
	Miles×1,000	10	20	30	40	50	60	70	80
	Km×1,000	15	30	45	60	75	90	105	120
Steering gear rack, linkage and boots	I	I	I	I	I	I	I	I	I
Driveshaft and boots		I			I		I		I
Tire (pressure & tread wear)	I	I	I	I	I	I	I	I	I
Front suspension ball joints	I	I	I	I	I	I	I	I	I
Bolt and nuts on chassis and body	I	I	I	I	I	I	I	I	I
Air conditioner refrigerant (if equipped)	I	I	I	I	I	I	I	I	I
Air conditioner compressor (if equipped)	I	I	I	I	I	I	I	I	I
Climate control air filter (if equipped)	R	R	R	R	R	R	R	R	R
Manual transmission fluid (if equipped) *10					I				I
Automatic transmission fluid (if equipped)	No check, No service required								
Exhaust system		I			I		I		I

I : Inspect and if necessary, adjust, correct, clean or replace.

R : Replace or change.

*10: Manual transmission fluid should be changed anytime they have been submerged in water.

Maintenance Under Severe Usage and Low Mileage Conditions – Gasoline Engine (Except Europe)

The following items must be serviced more frequently on cars mainly used under severe driving conditions. Refer to the chart below for the appropriate maintenance intervals.

R : Replace I : Inspect and if necessary, adjust, correct, clean or replace

Maintenance item		Maintenance operation	Maintenance intervals	Driving condition
Engine oil and engine oil filter	For Middle East ^{*3} , Central & South America	R	Replace every 5,000 km (3,100 miles) or 6 months	A, B, C, D, E, F, G, H, I, K, L
	Except Middle East ^{*3} , Central & South America	R	Replace every 7,500 km (4,650 miles) or 6 months	
Air cleaner filter		R	Replace more frequently depending on the condition	C, E
Spark plugs		R	Replace more frequently depending on the condition	A, B, H, I
Steering gear rack, linkage and boots		I	Inspect more frequently depending on the condition	C, D, E, F, G
Front suspension ball joints		I	Inspect more frequently depending on the condition	C, D, E, F, G

Maintenance item	Maintenance operation	Maintenance intervals	Driving condition
Disc brakes and pads, calipers and rotors	I	Inspect more frequently depending on the condition	C, D, E, G, H
Parking brake	I	Inspect more frequently depending on the condition	C, D, G, H
Driveshaft and boots	I	Inspect more frequently depending on the condition	C, D, E, F, G, H, I
Manual transmission fluid (if equipped)	R	Every 120,000 km (80,000 miles)	C, F, G, I, K
Automatic transmission fluid (if equipped)	R	Every 100,000 km (62,000 miles)	A, C, F, G, I
Climate control air filter (if equipped)	R	Replace more frequently depending on the condition	C, E

Severe driving conditions

- A : Repeatedly driving short distance of less than 8 km (5 miles) in normal temperature or less than 16 km (10 miles) in freezing temperature
- B : Extensive engine idling or low speed driving for long distances
- C : Driving on rough, dusty, muddy, unpaved, graveled or salt spread roads
- D : Driving in areas using salt or other corrosive materials or in very cold weather
- E : Driving in the condition of inflowing sand or dust into engine

F : Driving in heavy traffic area

G : Driving on uphill, downhill, or mountain roads repeatedly

H : Towing a trailer, or using a camper or roof rack

I : Driving for patrol car, taxi, commercial car or vehicle towing

J : Driving over 140 km/h (87 mile/h)

K : Driving over 170 km/h (106 mile/h)

L : Frequently driving in stop-and-go conditions

Normal Maintenance Schedule – Diesel Engine

MAINTENANCE ITEM	MAINTENANCE INTERVALS	Number of months or driving distance, whichever comes first								
		Months	12	24	36	48	60	72	84	96
		Miles×1,000	12.5	25	37.5	50	62.5	75	87.5	100
		Km×1,000	20	40	60	80	100	120	140	160
Drive belts *1		At first, inspect at 80,000 km (50,000 miles) or 48 months, after every 20,000 km (12,500 miles) or 12 months								
Engine oil and engine oil filter *2 *3		R	R	R	R	R	R	R	R	
Tensioner/idler/damper pulley		Inspect when replacing the drive belt								
Air cleaner filter		I	R	I	R	I	R	I	R	
Fuel filler cap				I			I			

I : Inspect and if necessary, adjust, correct, clean or replace.

R : Replace or change.

*1 : Inspect and if necessary correct or replace. Inspect drive belt tensioner, idler and alternator pulley and if necessary correct or replace.

*2 : Check the engine oil level and leak every 500 km (350 miles) or before starting a long trip.

*3 : The engine oil level should be checked regularly and maintained properly. Operating with an insufficient amount oil can damage the engine, and such damage is not covered by warranty.

Normal Maintenance Schedule (Cont.) – Diesel Engine

MAINTENANCE ITEM	MAINTENANCE INTERVALS	Number of months or driving distance, whichever comes first								
		Months	12	24	36	48	60	72	84	96
		Miles×1,000	12.5	25	37.5	50	62.5	75	87.5	100
		Km×1,000	20	40	60	80	100	120	140	160
Fuel filter cartridge *4		I	I	R	I	I	R	I	I	
Fuel lines, hoses and connections		I	I	I	I	I	I	I	I	
Cooling system		Inspect "Coolant level adjustment and leak" every day Inspect "Water pump" when replacing the drive belt or timing belt								
Engine coolant *5		At first, replace at 100,000 km (62,500 miles) or 60 months: after that, replace every 40,000 km (25,000 miles) or 24 months *6								
Battery condition		I	I	I	I	I	I	I	I	

I : Inspect and if necessary, adjust, correct, clean or replace.

R : Replace or change.

*4 : This maintenance schedule depends on fuel quality. It is applicable only when using a qualified fuel < "EN590 or equivalent">. If the diesel fuel specification doesn't meet the EN590, it must be replaced more frequently. If there are some important safety matters like fuel flow restriction, surging, loss of power, hard starting problem etc, replace the fuel filter immediately regardless of maintenance schedule and we recommend that you consult an authorized HYUNDAI dealer for details.

Normal Maintenance Schedule (Cont.) – Diesel Engine

MAINTENANCE ITEM	MAINTENANCE INTERVALS	Number of months or driving distance, whichever comes first							
	Months	12	24	36	48	60	72	84	96
	Miles×1,000	12.5	25	37.5	50	62.5	75	87.5	100
	Km×1,000	20	40	60	80	100	120	140	160
All electrical systems		I	I	I	I	I	I	I	I
Brake lines, hoses and connections		I	I	I	I	I	I	I	I
Brake pedal, clutch pedal (if equipped)		I	I	I	I	I	I	I	I
Parking brake		I	I	I	I	I	I	I	I
Brake/clutch fluid		I	R	I	R	I	R	I	R
Disc brakes and pads		I	I	I	I	I	I	I	I
Drum brakes and linings (if equipped)			I		I		I		I

I : Inspect and if necessary, adjust, correct, clean or replace.

R : Replace or change.

*⁵ : When adding coolant, use only a qualified coolant additive for your vehicle and never mix hard water in the coolant filled at the factory. An improper coolant mixture can result in serious malfunction or engine damage.

*⁶ : For your convenience, it can be replaced prior to its interval when you do maintenance of other items.

Normal Maintenance Schedule (Cont.) – Diesel Engine

MAINTENANCE ITEM	MAINTENANCE INTERVALS	Number of months or driving distance, whichever comes first								
		Months	12	24	36	48	60	72	84	96
		Miles×1,000	12.5	25	37.5	50	62.5	75	87.5	100
		Km×1,000	20	40	60	80	100	120	140	160
Steering gear rack, linkage and boots		I	I	I	I	I	I	I	I	
Drive shaft and boots		I	I	I	I	I	I	I	I	
Tire (pressure & tread wear)		I	I	I	I	I	I	I	I	
Front suspension ball joints		I	I	I	I	I	I	I	I	
Bolt and nuts on chassis and body		I	I	I	I	I	I	I	I	
Air conditioner refrigerant (if equipped)		I	I	I	I	I	I	I	I	
Air conditioner compressor (if equipped)		I	I	I	I	I	I	I	I	
Climate control air filter		Replace every 30,000 km (20,000 miles) or 18 months								
Manual transmission fluid ^{*7} (if equipped)		Inspect every 60,000 km or 48 months								
Dual clutch transmission fluid ^{*7} (if equipped)				I			I			

I : Inspect and if necessary, adjust, correct, clean or replace.

R : Replace or change.

^{*7} : Manual transmission/Dual clutch transmission fluid should be changed anytime they have been submerged in water.

Maintenance Under Severe Usage and Low Mileage Conditions – Diesel Engine

The following items must be serviced more frequently on cars mainly used under severe driving conditions. Refer to the chart below for the appropriate maintenance intervals.

R : Replace I : Inspect and if necessary, adjust, correct, clean or replace

Maintenance item	Maintenance operation	Maintenance intervals	Driving condition
Engine oil and engine oil filter	R	Every 10,000 km (6,200 miles) or 6 months	A, B, C, F, G, H, I, J, K, L
Air cleaner filter	R	Replace more frequently depending on the condition	C, E
Manual transmission fluid (if equipped)	R	Every 120,000 km (80,000 miles)	C, D, E, G, H, I, K
Dual clutch transmission fluid (if equipped)	R	Every 120,000 km (80,000 miles)	A, C, D, E, G, H, I, K
Steering gear rack, linkage and boots	I	Replace more frequently depending on the condition	C, D, E, F, G
Front suspension ball joints	I	Inspect more frequently depending on the condition	C, D, E, F, G

Maintenance item	Maintenance operation	Maintenance intervals	Driving condition
Disc brakes and pads, calipers and rotors	I	Inspect more frequently depending on the condition	C, D, E, G, H
Parking brake	I	Inspect more frequently depending on the condition	C, D, G, H
Driveshaft and boots	I	Inspect more frequently depending on the condition	C, D, E, F, G, H, I, J, K, L
Climate control air filter	R	Replace more frequently depending on the condition	C, E

Severe driving conditions

A : Repeated short distance driving

B : Extensive idling

C : Driving in dusty, rough roads

D : Driving in areas using salt or other corrosive materials or in very cold weather

E : Driving in the condition of inflowing sand or dust into engine

F : Driving in heavy traffic area

G : Driving in mountainous areas.

H : Towing a trailer

I : Driving for patrol car, taxi, commercial car or vehicle towing

J : Driving in very cold weather

K : Driving over 170 km/h (106 mile/h)

L : Frequently driving in stop-and-go conditions

EXPLANATION OF SCHEDULED MAINTENANCE ITEMS

Engine oil and filter

The engine oil and filter should be changed at the intervals specified in the maintenance schedule. If the car is being driven in severe conditions, more frequent oil and filter changes are required.

Drive belts

Inspect all drive belts for evidence of cuts, cracks, excessive wear or oil saturation and replace if necessary. Drive belts should be checked periodically for proper tension and adjusted as necessary.



CAUTION

When you are inspecting the belt, place the ignition switch to the LOCK/OFF or ACC position.

Fuel filter (cartridge)

A clogged filter can limit the speed at which the vehicle may be driven, damage the emission system and cause multiple issues such as hard starting. If an excessive amount of foreign matter accumulates in the fuel tank, the filter may require replacement more frequently.

After installing a new filter, run the engine for several minutes, and check for leaks at the connections. We recommend that the fuel filter be replaced by an authorized HYUNDAI dealer.

Fuel lines, fuel hoses and connections

Check the fuel lines, fuel hoses and connections for leakage and damage. We recommend that the fuel lines, fuel hoses and connections be replaced by an authorized HYUNDAI dealer.

Vapor hose and fuel filler cap

The vapor hose and fuel filler cap should be inspected at those intervals specified in the maintenance schedule. Make sure that a new vapor hose or fuel filler cap is correctly replaced.

Air cleaner filter

We recommend that the air cleaner filter be replaced by an authorized HYUNDAI dealer.

Spark plugs

Make sure to install new spark plugs of the correct heat range.

WARNING

Do not disconnect and inspect spark plugs when the engine is hot. You may burn yourself.

Valve clearance

Inspect excessive valve noise and/or engine vibration and adjust if necessary. We recommend that the system be serviced by an authorized HYUNDAI dealer.

Cooling system

Check the cooling system parts, such as radiator, coolant reservoir, hoses and connections for leakage and damage. Replace any damaged parts.

Engine coolant

The coolant should be changed at the intervals specified in the maintenance schedule.

Automatic transmission fluid

Automatic transmission fluid should not be checked under normal usage conditions.

We recommend that the automatic transmission fluid changed by an authorized HYUNDAI dealer according to the maintenance schedule.

Information

Automatic transmission fluid color is basically red.

As the vehicle is driven, the automatic transmission fluid will begin to look darker.

It is normal condition and you should not judge the need to replace the fluid based upon the changed color.

NOTICE

The use of a non-specified fluid could result in transmission malfunction and failure.

Use only specified automatic transmission fluid. (Refer to “Recommended lubricants and capacities” in section 8.)

Manual transmission fluid (if equipped)

Inspect the manual transmission fluid according to the maintenance schedule.

Dual clutch transmission fluid (if equipped)

Inspect the dual clutch transmission fluid according to the maintenance schedule.

Brake hoses and lines

Visually check for proper installation, chafing, cracks, deterioration and any leakage. Replace any deteriorated or damaged parts immediately.

Brake fluid

Check brake fluid level in the brake fluid reservoir. The level should be between “MIN” and “MAX” marks on the side of the reservoir. Use only hydraulic brake fluid conforming to DOT 3 or DOT 4 specification.

Parking brake

Inspect the parking brake system including the parking brake lever (or pedal) and cables.

Brake pads, calipers and rotors

Check the pads for excessive wear, discs for run out and wear, and calipers for fluid leakage.

For more information on checking the pads or lining wear limit, refer to the HYUNDAI web site.

(<http://brakemanual.hmc.co.kr>)

Suspension mounting bolts

Check the suspension connections for looseness or damage. Retighten to the specified torque.

Steering gear box, linkage & boots/lower arm ball joint

With the vehicle stopped and engine off, check for excessive free-play in the steering wheel.

Check the linkage for bends or damage. Check the dust boots and ball joints for deterioration, cracks, or damage. Replace any damaged parts.

Drive shafts and boots

Check the drive shafts, boots and clamps for cracks, deterioration, or damage. Replace any damaged parts and, if necessary, repack the grease.

Air conditioning refrigerant/compressor

Check the air conditioning lines and connections for leakage and damage.

ENGINE OIL

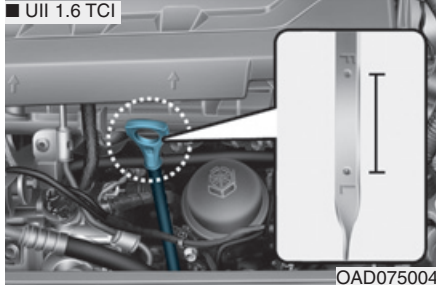
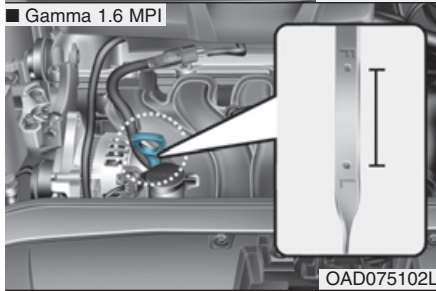
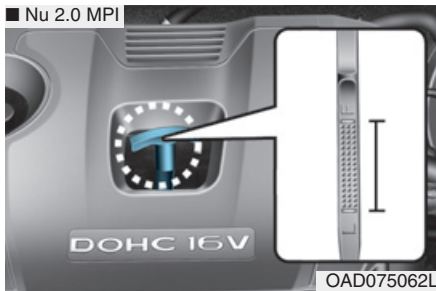

Checking the engine oil level

1. Be sure the vehicle is on level ground.
2. Start the engine and allow it to reach normal operating temperature.
3. Turn the engine off and wait for a few minutes (about 5 minutes) for the oil to return to the oil pan.
4. Pull the dipstick out, wipe it clean, and re-insert it fully.

5. Pull the dipstick out again and check the level. The level should be between F and L.

NOTICE

- Do not overfill the engine oil. It may damage the engine.
- Do not spill engine oil, when adding or changing engine oil. If you drop the engine oil on the engine room, wipe it off immediately.
- When you wipe the oil level gauge, you should wipe it with a clean cloth. When mixed with debris, it can cause engine damage.

⚠ WARNING

Radiator hose

Be very careful not to touch the radiator hose when checking or adding the engine oil as it may be hot enough to burn you.

NOTICE - Diesel Engine

Overfilling the diesel engine oil may cause severe dieseling due to the churning effect. It may damage the diesel engine with the abrupt engine speed incensement, combustion noise, and white smoke emission.

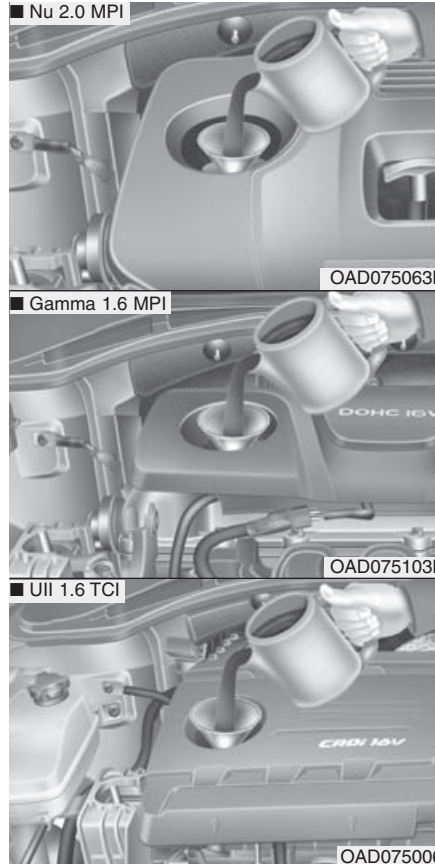

If it is near or at L, add enough oil to bring the level to F. **Do not overfill.**

Use a funnel to help prevent oil from being spilled on engine components.

Use only the specified engine oil. (Refer to “Recommended lubricants and capacities” in Chapter 8.)

Checking the engine oil and filter



We recommend that the engine oil and filter be replaced by an authorized HYUNDAI dealer.

WARNING

Used engine oil may cause irritation or cancer of the skin if left in contact with the skin for prolonged periods of time. Used engine oil contains chemicals that have caused cancer in laboratory animals. Always protect your skin by washing your hands thoroughly with soap and warm water as soon as possible after handling used oil.

ENGINE COOLANT

The high-pressure cooling system has a reservoir filled with year-round antifreeze coolant. The reservoir is filled at the factory.

Check the antifreeze protection and coolant concentration level at least once a year, at the beginning of the winter season, and before traveling to a colder climate.

NOTICE

- When the engine overheats from low engine coolant, suddenly adding engine coolant may cause cracks in the engine. To prevent damage, add engine coolant slowly in small quantities.
- Do not drive with no engine coolant. It may cause water pump failure and engine seizure, etc.

Checking the engine coolant level

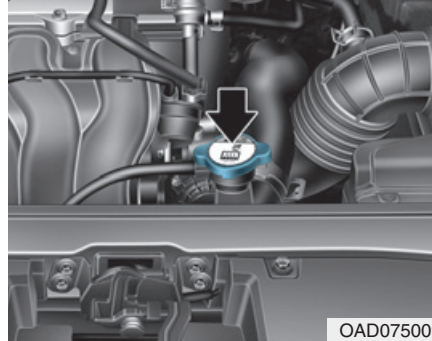

⚠ WARNING



Removing radiator cap

- Never attempt to remove the radiator cap while the engine is operating or hot.

(Continued)

(Continued)

Doing so might lead to cooling system and engine damage and could result in serious personal injury from escaping hot coolant or steam.

- Turn the engine off and wait until it cools down. Use extreme care when removing the radiator cap. Wrap a thick towel around it, and turn it counterclockwise slowly to the first stop. Step back while the pressure is released from the cooling system.
- When you are sure all the pressure has been released, press down on the cap, using a thick towel, and continue turning counterclockwise to remove it.

- Even if the engine is not operating, do not remove the radiator cap or the drain plug while the engine and radiator are hot. Hot coolant and steam may still blow out under pressure, causing serious injury.

⚠ WARNING



The electric motor (cooling fan) is controlled by engine coolant temperature, refrigerant pressure and vehicle speed. It may sometimes operate even when the engine is not running. Use extreme caution when working near the blades of the cooling fan so that you are not injured by a rotating fan blades. As the engine coolant temperature decreases, the electric motor will automatically shut off. This is a normal condition.

The electric motor (cooling fan) may operate until you disconnect the negative battery cable.

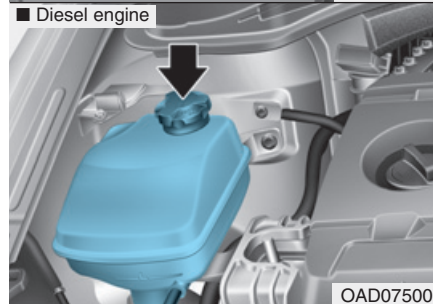
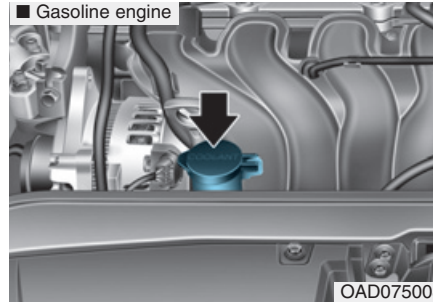

Check the condition and connections of all cooling system hoses and heater hoses. Replace any swollen or deteriorated hoses.

The coolant level should be filled between F (MAX) and L (MIN) marks on the side of the coolant reservoir when the engine is cool.

If the coolant level is low, add enough distilled (deionized) water. Bring the level to F (MAX), but do not overfill.

If frequent additions are required, we recommend that the system be inspected by an authorized HYUNDAI dealer.

Recommended engine coolant

- When adding coolant, use only deionized water or soft water for your vehicle and never mix hard water in the coolant filled at the factory. An improper coolant mixture can result in serious malfunction or engine damage.
- The engine in your vehicle has aluminum engine parts and must be protected by an phosphate based ethylene-glycol coolant to prevent corrosion and freezing.
- DO NOT USE alcohol or methanol coolant or mix them with the specified coolant.
- Do not use a solution that contains more than 60% antifreeze or less than 35% antifreeze, which would reduce the effectiveness of the solution.

For mixture percentage, refer to the following table.

Ambient Temperature	Mixture Percentage (volume)	
	Antifreeze	Water
-15°C (5°F)	35	65
-25°C (-13°F)	40	60
-35°C (-31°F)	50	50
-45°C (-49°F)	60	40

i Information

If in doubt about the mix ratio, a 50% water and 50% antifreeze mix is the easiest to mix together as it will be the same quantity of each. It is suitable to use for most temperature ranges of -35°C (-31°F) and higher.

Changing the coolant

We recommend that the coolant be replaced by an authorized HYUNDAI dealer.

NOTICE

Put a thick cloth or fabric around the radiator cap before refilling the coolant in order to prevent the coolant from overflowing into engine parts such as generator.

! WARNING

- Do not use engine coolant or antifreeze in the washer fluid reservoir.
- Engine coolant can severely obscure visibility when sprayed on the windshield and may cause loss of vehicle control or damage to paint and body trim.

BRAKE/CLUTCH FLUID (IF EQUIPPED)

Checking the brake/clutch fluid level

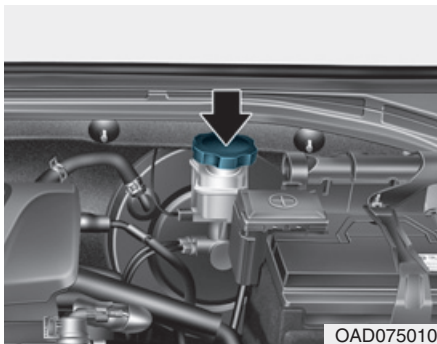

Check the fluid level in the reservoir periodically. The fluid level should be between MAX and MIN marks on the side of the reservoir.

Before removing the reservoir cap and adding brake/clutch fluid, clean the area around the reservoir cap thoroughly to prevent brake/clutch fluid contamination.

If the level is low, add fluid to the MAX level. The level will fall with accumulated mileage. This is a normal condition associated with the wear of the brake linings.

If the fluid level is excessively low, we recommend that the system be checked by an authorized HYUNDAI dealer.

i Information

Use only the specified brake/clutch fluid. (Refer to “Recommended lubricants and capacities” in chapter 8.)

Never mix different types of fluid.

! WARNING

In the event the brake/clutch system requires frequent additions of fluid, we recommend that the system be inspected by an authorized HYUNDAI dealer.

i Information

Before removing the brake/clutch filler cap, read the warning on the cap.

i Information

Clean filler cap before removing.

Use only DOT3 or DOT4 brake/clutch fluid from a sealed container.

⚠ WARNING

When changing and adding brake/clutch fluid, handle it carefully. Do not let it come in contact with your eyes. If brake/clutch fluid should come in contact with your eyes, immediately flush them with a large quantity of fresh tap water. Have your eyes examined by a doctor as soon as possible.

NOTICE

Do not allow brake/clutch fluid to contact the vehicle's body paint, as paint damage will result. Brake/clutch fluid, which has been exposed to open air for an extended time should never be used as its quality cannot be guaranteed. It should be disposed of properly. Don't put in the wrong kind of fluid.

A few drops of mineral-based oil, such as engine oil, in your brake/clutch system can damage brake/clutch system parts.

WASHER FLUID

Checking the washer fluid level

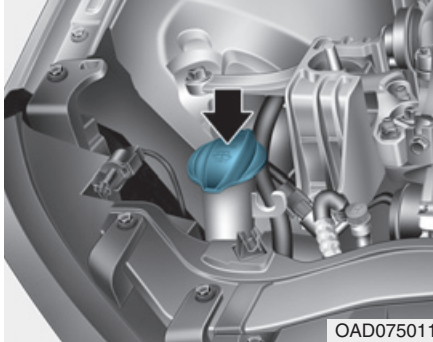

The reservoir is translucent so that you can check the level with a quick visual inspection.

Check the fluid level in the washer fluid reservoir and add fluid if necessary.

Plain water may be used if washer fluid is not available.

However, use washer solvent with antifreeze characteristics in cold climates to prevent freezing.

NOTICE - Coolant

Do not use engine coolant or antifreeze in the washer fluid reservoir.

WARNING

- Engine coolant can severely obscure visibility when sprayed on the windshield and may cause loss of vehicle control or damage to paint and body trim.
- Windshield Washer fluid agents contain some amounts of alcohol and can be flammable under certain circumstances. Do not allow sparks or flame to contact the washer fluid or the washer fluid reservoir. Damage to the vehicle or occupants could occur.
- Windshield washer fluid is poisonous to humans and animals. Do not drink and avoid contacting windshield washer fluid. Serious injury or death could occur.

PARKING BRAKE

Checking the parking brake

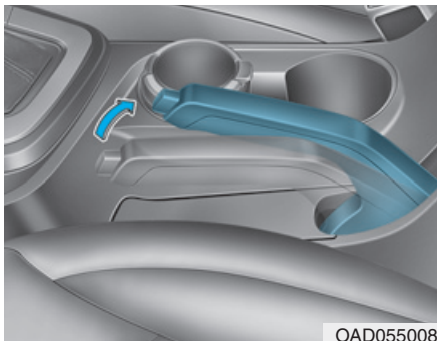

OAD055008

Check the stroke of the parking brake by counting the number of “clicks” heard while fully applying it from the released position. Also, the parking brake alone should securely hold the vehicle on a fairly steep grade. If the stroke is more or less than specified, we recommend that the system be serviced by an authorized HYUNDAI dealer.

Stroke : 5~6 “clicks” at a force of 20 kg (44 lbs, 196 N).

FUEL FILTER (FOR DIESEL)

Draining water from fuel filter

The fuel filter in the diesel engine operates the critical function of separating water from the fuels and accumulating the water in its bottom.

When enough water is accumulated inside the fuel filter, the warning light illuminates with the ignition switch in the ON position.

In this case, we recommend you to have the system checked by an authorized HYUNDAI dealer.

NOTICE

When the accumulated water is not drained at a proper timing, water may permeate in the fuel filter, damaging the major vehicle components, such as the fuel system.

i Information

When replacing the fuel filter cartridge, we recommend that you use parts for replacement from an authorized HYUNDAI dealer.

AIR CLEANER

Filter replacement

■ Gasoline engine

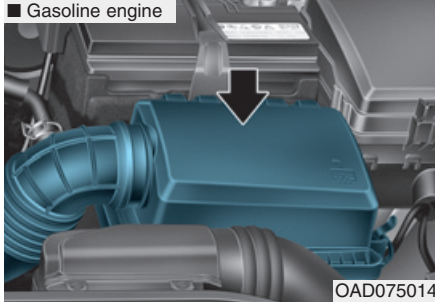

■ Diesel engine

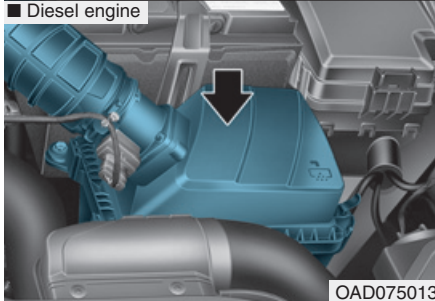

The air cleaner filter can be cleaned for inspection using compressed air. Do not attempt to wash or to rinse it, as water will damage the filter. If soiled, the air cleaner filter must be replaced.

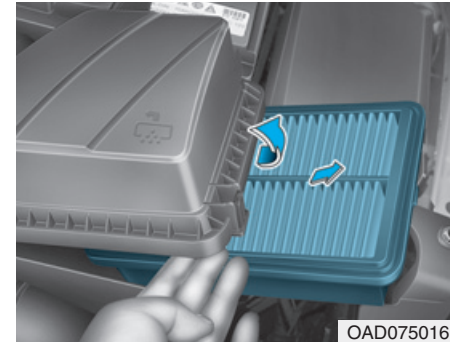
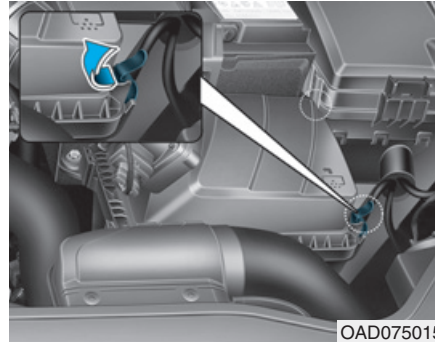

1. Loosen the air cleaner cover attaching clips and open the cover.

2. Wipe the inside of the air cleaner.
3. Replace the air cleaner filter.
4. Lock the cover with the cover attaching clips.

i Information

If the vehicle is operated in extremely dusty or sandy areas, replace the element more often than the usual recommended intervals (refer to “Maintenance Under Severe Usage Conditions” in this chapter).

NOTICE

- Do not drive with the air cleaner filter removed. This will result in excessive engine wear.
- When removing the air cleaner filter, be careful that dust or dirt does not enter the air intake, or damage may result.
- Use HYUNDAI genuine parts, use of non-genuine parts could damage the air flow sensor.

CLIMATE CONTROL AIR FILTER

Filter inspection

If the vehicle is operated in the severely air-polluted cities or on dusty rough roads for a long period, it should be inspected more frequently and replaced earlier. When you, the owner, replace the climate control air filter, replace it performing the following procedure, and be careful to avoid damaging other components.

Replace the filter according to the Maintenance Schedule.

NOTICE

Install a new climate control air filter in the correct direction with the arrow symbol(↓) facing downwards. Otherwise, the climate control effects may decrease, possibly with a noise.

Filter replacement

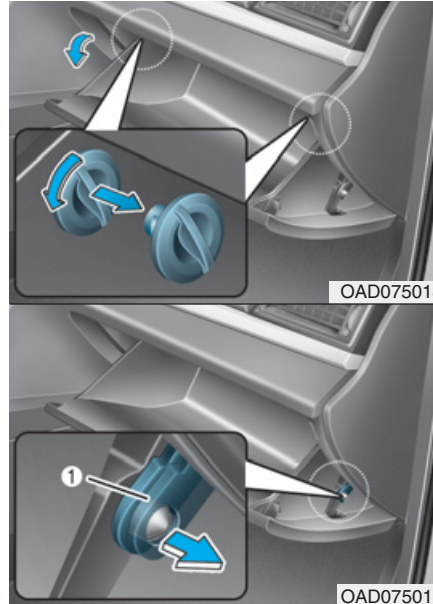

1. With the glove box open, remove the stoppers on both sides.
2. Remove the support strap (1).

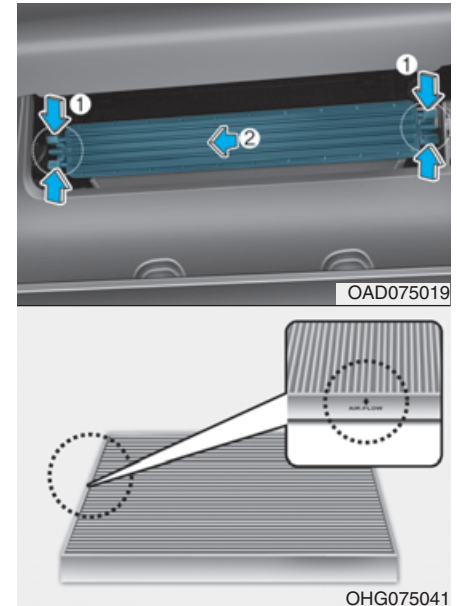

3. Remove the climate control air filter case while pressing the lock on the both side of the cover.
4. Replace the climate control air filter.
5. Reassemble in the reverse order of disassembly.

WIPER BLADES

Blade inspection

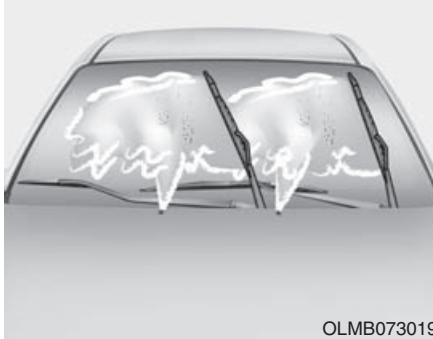

OLMB073019

i Information

Commercial hot waxes applied by automatic car washes have been known to make the windshield difficult to clean.

Contamination of either the windshield or the wiper blades with foreign matter can reduce the effectiveness of the windshield wipers.

Common sources of contamination are insects, tree sap, and hot wax treatments used by some commercial car washes. If the blades are not wiping properly, clean both the window and the blades with a good cleaner or mild detergent, and rinse thoroughly with clean water.

NOTICE

To prevent damage to the wiper blades, do not use gasoline, kerosene, paint thinner, or other solvents on or near them.

Blade replacement

When the wipers no longer clean adequately, the blades may be worn or cracked, and require replacement.

NOTICE

To prevent damage to the wiper arms or other components, do not attempt to move the wipers manually.

NOTICE

The use of a non-specified wiper blade could result in wiper malfunction and failure.



CAUTION

Do not allow the wiper arm to fall against the windshield, since it may chip or crack the windshield.

Type A

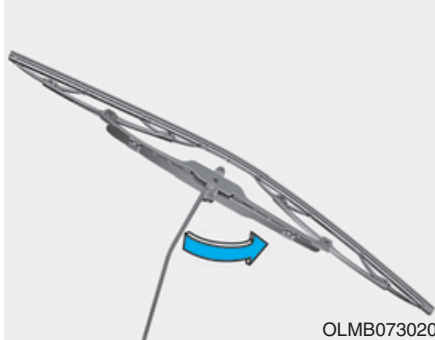

1. Raise the wiper arm and turn the wiper blade assembly to expose the plastic locking clip.

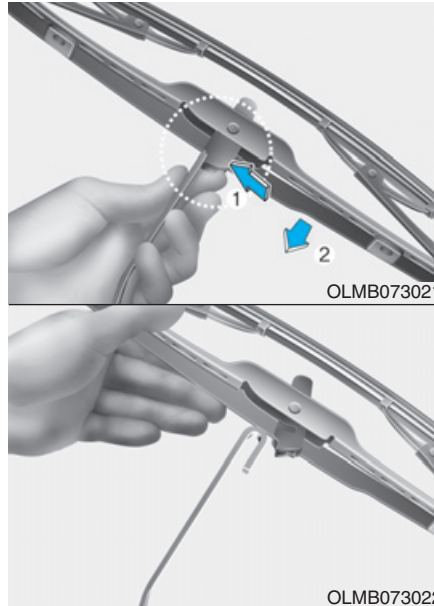

2. Compress the clip and slide the blade assembly downward.
3. Lift it off the arm.
4. Install the blade assembly in the reverse order of removal.

Type B



1. Raise the wiper arm.

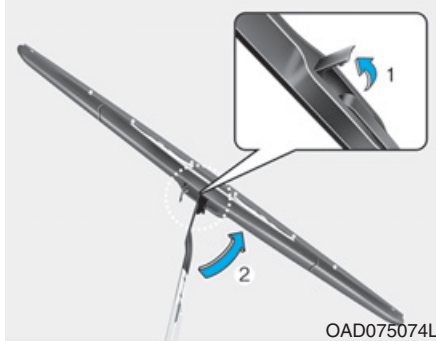

2. Lift up the wiper blade clip (1).
Then lift up the wiper blade (2).

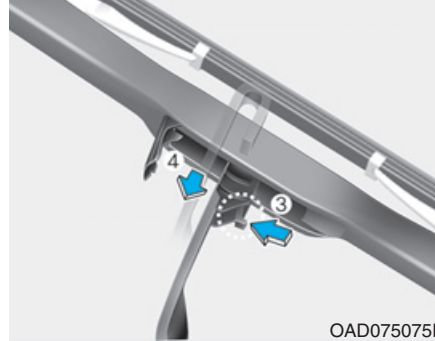

3. While pushing the lock (3), pull
down the wiper blade (4).



4. Remove the wiper blade from the
wiper arm (5).
5. Install a new wiper blade assembly
in the reverse order of removal.
6. Return the wiper arm on the wind-
shield.

BATTERY

For best battery service

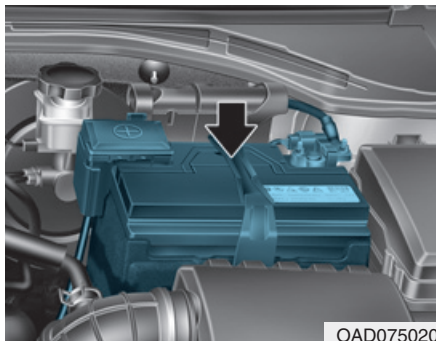

OAD075020

- Keep the battery securely mounted.
- Keep the battery top clean and dry.
- Keep the terminals and connections clean, tight, and coated with petroleum jelly or terminal grease.
- Rinse any spilled electrolyte from the battery immediately with a solution of water and baking soda.
- If the vehicle is not going to be used for an extended time, disconnect the battery cables.

i Information

The battery, which is originally installed in your vehicle, is maintenance free. However, your vehicle is equipped with a battery marked with **LOWER** and **UPPER** on the side, you should check the electrolyte level.

The electrolyte level should be between the **LOWER** and the **UPPER**. When the electrolyte level is low, add distilled (or de-mineralized) water. (Never add sulfuric acids or other electrolyte).

Be careful not to spill distilled (or de-mineralized) water over the battery surface or other adjacent components.

Also, do not overfill the battery cells.

If not, it may corrode the battery or other components. Finally, securely close the cell cap. However, we recommend you to contact an authorized **HYUNDAI** dealer for better battery service.

⚠ WARNING

To prevent **SERIOUS INJURY** or **DEATH** to you or bystanders, always follow these precautions when working near or handling the battery:



Always read and follow instructions carefully when handling a battery.



Wear eye protection designed to protect the eyes from acid splashes.



Keep all flames, sparks, or smoking materials away from the battery.



Hydrogen is always present in battery cells, is highly combustible, and may explode if ignited.



Keep batteries out of reach of children.

(Continued)

(Continued)



Batteries contain sulfuric acid which is highly corrosive. Do not allow acid to contact your eyes, skin or clothing.

If acid gets into your eyes, flush your eyes with clean water for at least 15 minutes and get immediate medical attention. If acid gets on your skin, thoroughly wash the area. If you feel pain or a burning sensation, get medical attention immediately.

- When lifting a plastic-cased battery, excessive pressure on the case may cause battery acid to leak. Lift with a battery carrier or with your hands on opposite corners.
- Do not attempt to jump start your vehicle if your battery is frozen.

(Continued)

(Continued)

- NEVER attempt to recharge the battery when the vehicle's battery cables are connected to the battery.
- The electrical ignition system works with high voltage. NEVER touch these components with the engine running or when the Engine Start/Stop button is in the ON position.
- Do not allow the (+) and (-) jumper cables to touch. It may cause sparks.
- The battery may rupture or explode when you jump start with a low or frozen battery.

NOTICE

If you connect unauthorized electronic devices to the battery, the battery may be discharged. Never use unauthorized devices.

Battery capacity label

■ Example



OLMB073072

* The actual battery label in the vehicle may differ from the illustration.

1. AGM60L-DIN : The HYUNDAI model name of battery
2. 12V : The nominal voltage
3. 60Ah(20HR) : The nominal capacity (in Ampere hours)
4. 100RC : The nominal reserve capacity (in min.)
5. 640CCA : The cold-test current in amperes by SAE
6. 512A : The cold-test current in amperes by EN

Battery recharging

Your vehicle has a maintenance-free, calcium-based battery.

- If the battery becomes discharged in a short time (because, for example, the headlights or interior lights were left on while the vehicle was not in use), recharge it by slow charging (trickle) for 10 hours.
- If the battery gradually discharges because of high electric load while the vehicle is being used, recharge it at 20-30A for two hours.

WARNING

When recharging the battery, observe the following precautions:

- **Before performing maintenance or recharging the battery, turn off all accessories and stop the engine.**
- **Do not allow cigarettes, sparks, or flame near the battery.**
- **Wear eye protection when checking the battery during charging.**
- **The battery must be removed from the vehicle and placed in an area with good ventilation.**
- **Watch the battery during charging, and stop or reduce the charging rate if the battery cells begin gassing (boiling) violently or if the temperature of the electrolyte of any cell exceeds 49°C (120°F).**

(Continued)

(Continued)

- **The negative battery cable must be removed first and installed last when the battery is disconnected.**
- **Disconnect the battery charger in the following order.**
 - 1. Turn off the battery charger main switch.**
 - 2. Unhook the negative clamp from the negative battery terminal.**
 - 3. Unhook the positive clamp from the positive battery terminal.**

Reset items

Items should be reset after the battery has been discharged or the battery has been disconnected.

- Auto up/down window (See chapter 3)
- Sunroof (See chapter 3)
- Trip computer (See chapter 3)
- Climate control system (See chapter 3)

TIRES AND WHEELS

Tire care

For proper maintenance, safety, and maximum fuel economy, you must always maintain recommended tire inflation pressures and stay within the load limits and weight distribution recommended for your vehicle.

Recommended cold tire inflation pressures

All tire pressures (including the spare) should be checked when the tires are cold. "Cold Tires" means the vehicle has not been driven for at least three hours or driven less than 1.6 km (1 mile).

Recommended pressures must be maintained for the best ride, top vehicle handling, and minimum tire wear.

For recommended inflation pressure refer to "Tire and wheels" in chapter 8.

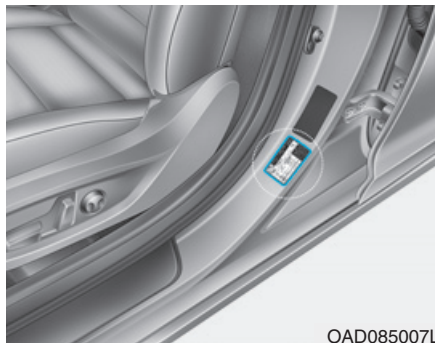

OAD085007L

All specifications (sizes and pressures) can be found on a label attached to the vehicle.

WARNING

Tire underinflation

Severe underinflation (70 kPa (10 psi) or more) can lead to severe heat build-up, causing blowouts, tread separation and other tire failures that can result in the loss of vehicle control leading to severe injury or death. This risk is much higher on hot days and when driving for long periods at high speeds.

 **CAUTION**

- Underinflation also results in excessive wear, poor handling and reduced fuel economy. Wheel deformation also is possible. Keep your tire pressures at the proper levels. If a tire frequently needs refilling, we recommend that the system be checked by an authorized HYUNDAI dealer.
- Overinflation produces a harsh ride, excessive wear at the center of the tire tread, and a greater possibility of damage from road hazards.

 **CAUTION**

- Warm tires normally exceed recommended cold tire pressures by 28 to 41 kPa (4 to 6 psi). Do not release air from warm tires to adjust the pressure or the tires will be underinflated.
- Be sure to reinstall the tire inflation valve caps. Without the valve cap, dirt or moisture could get into the valve core and cause air leakage. If a valve cap is missing, install a new one as soon as possible.

 **WARNING****Tire inflation**

Overinflation or underinflation can reduce tire life, adversely affect vehicle handling, and lead to sudden tire failure. This could result in loss of vehicle control and potential injury.

 **CAUTION****Tire pressure**

Always observe the following:

- Check tire pressure when the tires are cold. (After vehicle has been parked for at least three hours or hasn't been driven more than 1.6 km (1 mile) since startup.)
- Check the pressure of your spare tire each time you check the pressure of other tires.
- Never overload your vehicle. Be careful not to overload a vehicle luggage rack if your vehicle is equipped with one.
- Worn, old tires can cause accidents. If your tread is badly worn, or if your tires have been damaged, replace them.

Checking tire inflation pressure

Check your tires once a month or more.

Also, check the tire pressure of the spare tire.

How to check

Use a good quality gage to check tire pressure. You can not tell if your tires are properly inflated simply by looking at them. Radial tires may look properly inflated even when they're underinflated.

Check the tire's inflation pressure when the tires are cold. - "Cold" means your vehicle has been sitting for at least three hours or driven no more than 1.6 km (1 mile).

Remove the valve cap from the tire valve stem. Press the tire gage firmly onto the valve to get a pressure measurement. If the cold tire inflation pressure matches the recommended pressure on the tire and loading information label, no further adjustment is necessary. If the pressure is low, add air until you reach the recommended amount.

If you overfill the tire, release air by pushing on the metal stem in the center of the tire valve. Recheck the tire pressure with the tire gage. Be sure to put the valve caps back on the valve stems. They help prevent leaks by keeping out dirt and moisture.

WARNING

- **Inspect your tires frequently for proper inflation as well as wear and damage. Always use a tire pressure gauge.**
- **Tires with too much or too little pressure wear unevenly causing poor handling, loss of vehicle control, and sudden tire failure leading to accidents, injuries, and even death. The recommended cold tire pressure for your vehicle can be found in this manual and on the tire label located on the driver's side center pillar.**
- **Worn tires can cause accidents. Replace tires that are worn, show uneven wear, or are damaged.**
- **Remember to check the pressure of your spare tire. HYUNDAI recommends that you check the spare every time you check the pressure of the other tires on your vehicle.**

Tire rotation

To equalize tread wear, it is recommended that the tires be rotated every 12,000 km (7,500 miles) or sooner if irregular wear develops.

During rotation, check the tires for correct balance.

When rotating tires, check for uneven wear and damage. Abnormal wear is usually caused by incorrect tire pressure, improper wheel alignment, out-of-balance wheels, severe braking or severe cornering. Look for bumps or bulges in the tread or side of tire. Replace the tire if you find either of these conditions. Replace the tire if fabric or cord is visible. After rotation, be sure to bring the front and rear tire pressures to specification and check lug nut tightness.

Refer to "Tire and wheels" in section 8.

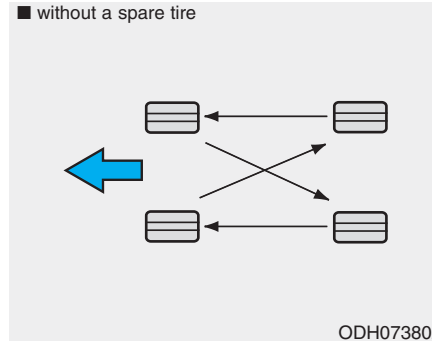

Disc brake pads should be inspected for wear whenever tires are rotated.

i Information

The outside and inside of the unsymmetrical tire is distinguishable. When installing an unsymmetrical tire, be sure to install the side marked "outside" face the outside. If the side marked "inside" is installed on the outside, it will have a bad effect on vehicle performance.

⚠ WARNING

- Do not use the compact spare tire for tire rotation.
- Do not mix bias ply and radial ply tires under any circumstances. This may cause unusual handling characteristics that could result in death, severe injury, or property damage.

Wheel alignment and tire balance

The wheels on your vehicle were aligned and balanced carefully at the factory to give you the longest tire life and best overall performance.

In most cases, you will not need to have your wheels aligned again. However, if you notice unusual tire wear or your vehicle pulling one way or the other, the alignment may need to be reset.

If you notice your vehicle vibrating when driving on a smooth road, your wheels may need to be rebalanced.

NOTICE

Improper wheel weights can damage your vehicle's aluminum wheels. Use only approved wheel weights.

Tire replacement



If the tire is worn evenly, a tread wear indicator will appear as a solid band across the tread. This shows there is less than 1.6 mm (1/16 in.) of tread left on the tire. Replace the tire when this happens.

Do not wait for the band to appear across the entire tread before replacing the tire.

⚠ WARNING

When replacing the tires, recheck and tighten the wheel nuts after driving about 1,000 km (620 miles). If the steering wheel shakes or the vehicle vibrates while driving, the tire is out of balance. Align the tire balance. If the problem is not solved, we recommend that you contact an authorized HYUNDAI dealer.

⚠ WARNING

- **Driving on worn-out tires is very hazardous and will reduce braking effectiveness, steering accuracy, and traction.**
- **Your vehicle is equipped with tires designed to provide for safe ride and handling capability. Do not use a size and type of tire and wheel that is different from the one that is originally installed on your vehicle. It can affect the safety and performance of your vehicle, which could lead to handling failure or rollover and serious injury. When replacing the tires, be sure to equip all four tires with the tire and wheel of the same size, type, tread, brand and load-carrying capacity.**

(Continued)

(Continued)

- **The use of any other tire size or type may seriously affect ride, handling, ground clearance, stopping distance, body to tire clearance, snow tire clearance, and speedometer reliability.**
- **It is best to replace all four tires at the same time. If that is not possible, or necessary, then replace the two front or two rear tires as a pair. Replacing just one tire can seriously affect your vehicle's handling.**
- **The ABS works by comparing the speed of the wheels. Tire size can affect wheel speed. When replacing tires, all 4 tires must use the same size originally supplied with the vehicle. Using tires of a different size can cause the ABS (Anti-lock Brake System) and ESC (Electronic Stability Control) (if equipped) to work irregularly.**

Compact spare tire replacement (if equipped)

A compact spare tire has a shorter tread life than a regular size tire. Replace it when you can see the tread wear indicator bars on the tire. The replacement compact spare tire should be the same size and design tire as the one provided with your new vehicle and should be mounted on the same compact spare tire wheel. The compact spare tire is not designed to be mounted on a regular size wheel, and the compact spare tire wheel is not designed for mounting a regular size tire.

Wheel replacement

When replacing the metal wheels for any reason, make sure the new wheels are equivalent to the original factory units in diameter, rim width and offset.

WARNING

A wheel that is not the correct size may adversely affect wheel and bearing life, braking and stopping abilities, handling characteristics, ground clearance, body-to-tire clearance, snow chain clearance, speedometer and odometer calibration, headlamp aim and bumper height.

Tire traction

Tire traction can be reduced if you drive on worn tires, tires that are improperly inflated or on slippery road surfaces. Tires should be replaced when tread wear indicators appear. To reduce the possibility of losing control, slow down whenever there is rain, snow or ice on the road.

Tire maintenance

In addition to proper inflation, correct wheel alignment helps to decrease tire wear. If you find a tire is worn unevenly, have your dealer check the wheel alignment.

When you have new tires installed, make sure they are balanced. This will increase vehicle ride comfort and tire life. Additionally, a tire should always be rebalanced if it is removed from the wheel.

Tire sidewall labeling

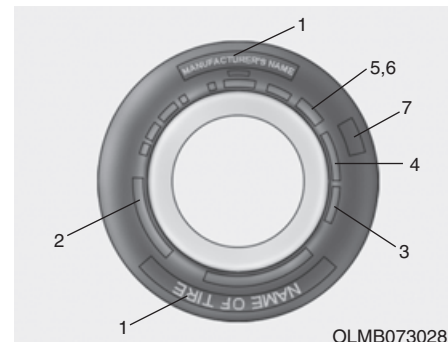

This information identifies and describes the fundamental characteristics of the tire and also provides the tire identification number (TIN) for safety standard certification. The TIN can be used to identify the tire in case of a recall.

1. Manufacturer or brand name

Manufacturer or Brand name is shown.

2. Tire size designation

A tire's sidewall is marked with a tire size designation. You will need this information when selecting replacement tires for your car. The following explains what the letters and numbers in the tire size designation mean.

Example tire size designation:

(These numbers are provided as an example only; your tire size designator could vary depending on your vehicle.)

205/65R16 95H

205 - Tire width in millimeters.

65 - Aspect ratio. The tire's section height as a percentage of its width.

R - Tire construction code (Radial).

16 - Rim diameter in inches.

95 - Load Index, a numerical code associated with the maximum load the tire can carry.

H - Speed Rating Symbol. See the speed rating chart in this section for additional information.

Wheel size designation

Wheels are also marked with important information that you need if you ever have to replace one. The following explains what the letters and numbers in the wheel size designation mean.

Example wheel size designation:

6.5JX16

6.5 - Rim width in inches.

J - Rim contour designation.

16 - Rim diameter in inches.

Tire speed ratings

The chart below lists many of the different speed ratings currently being used for passenger car tires. The speed rating is part of the tire size designation on the sidewall of the tire. This symbol corresponds to that tire's designed maximum safe operating speed.

Speed Rating Symbol	Maximum Speed
S	180 km/h (112 mph)
T	190 km/h (118 mph)
H	210 km/h (130 mph)
V	240 km/h (149 mph)
Z	Above 240 km/h (149 mph)

3. Checking tire life (TIN : Tire Identification Number)

Any tires that are over 6 years old, based on the manufacturing date, tire strength and performance, decline with age naturally (even unused spare tires). Therefore, the tires (including the spare tire) should be replaced by new ones. You can find the manufacturing date on the tire sidewall (possibly on the inside of the wheel), displaying the DOT Code. The DOT Code is a series of numbers on a tire consisting of numbers and English letters. The manufacturing date is designated by the last four digits (characters) of the DOT code.

DOT : XXXX XXXX OOOO

The front part of the DOT means a plant code number, tire size and tread pattern and the last four numbers indicate week and year manufactured.

For example:

DOT XXXX XXXX 1615 represents that the tire was produced in the 16th week of 2015.

WARNING

Tire age

Tires degrade over time, even when they are not being used. Regardless of the remaining tread, it is recommended that tires generally be replaced after six (6) years of normal service. Heat caused by hot climates or frequent high loading conditions can accelerate the aging process. Failure to follow this Warning can result in sudden tire failure, which could lead to a loss of control and an accident involving serious injury or death.

4. Tire ply composition and material

The number of layers or plies of rubber-coated fabric are in the tire. Tire manufacturers also must indicate the materials in the tire, which include steel, nylon, polyester, and others. The letter "R" means radial ply construction; the letter "D" means diagonal or bias ply construction; and the letter "B" means belted-bias ply construction.

5. Maximum permissible inflation pressure

This number is the greatest amount of air pressure that should be put in the tire. Do not exceed the maximum permissible inflation pressure. Refer to the Tire and Loading Information label for recommended inflation pressure.

6. Maximum load rating

This number indicates the maximum load in kilograms and pounds that can be carried by the tire. When replacing the tires on the vehicle, always use a tire that has the same load rating as the factory installed tire.

7. Uniform tire quality grading

Quality grades can be found where applicable on the tire sidewall between tread shoulder and maximum section width.

For example:

TREADWEAR 200
TRACTION AA
TEMPERATURE A

Tread wear

The tread wear grade is a comparative rating based on the wear rate of the tire when tested under controlled conditions on a specified government test course. For example, a tire graded 150 would wear one-and-a-half times (1½) as well on the government course as a tire graded 100.

The relative performance of tires depends upon the actual conditions of their use, however, and may depart significantly from the norm because of variations in driving habits, service practices and differences in road characteristics and climate.

These grades are molded on the side-walls of passenger vehicle tires. The tires available as standard or optional equipment on your vehicles may vary with respect to grade.

Traction - AA, A, B & C

The traction grades, from highest to lowest, are AA, A, B and C. Those grades represent the tires ability to stop on wet pavement as measured under controlled conditions on specified government test surfaces of asphalt and concrete. A tire marked C may have poor traction performance.

WARNING

The traction grade assigned to this tire is based on straight-ahead braking traction tests, and does not include acceleration, cornering, hydroplaning, or peak traction characteristics.

Temperature -A, B & C

The temperature grades are A (the highest), B and C representing the tire's resistance to the generation of heat and its ability to dissipate heat when tested under controlled conditions on a specified indoor laboratory test wheel.

Sustained high temperature can cause the material of the tire to degenerate and reduce tire life, and excessive temperature can lead to sudden tire failure. Grades B and A represent higher levels of performance on the laboratory test wheel than the minimum required by the law.

WARNING

Tire temperature

The temperature grade for this tire is established for a tire that is properly inflated and not overloaded. Excessive speed, underinflation, or excessive loading, either separately or in combination, can cause heat build-up and possible sudden tire failure. This can cause loss of vehicle control and serious injury or death.

Low aspect ratio tire (if equipped)

The low aspect ratio tires, of which aspect ratio is below 50, are equipped with for the sporty look.

Riding with high aspect ratio tires may be uncomfortable with unpleasant noises, because the low aspect ratio tires are optimized for handling and braking.

NOTICE

The sidewall of the low aspect ratio tire is thinner than the high aspect ratio tire. Thus, the wheel and the tire may be easily damaged. Thus, follow the below instructions.

- **Cautiously drive the vehicle on a rough road or off the road. Otherwise, the tires and wheels may be damaged. After driving those areas, inspect the tires and wheels.**
- **Slowly drive the vehicle to pass over a pothole, speed bump, manhole, or curb stone. Otherwise, the tires and wheels may be damaged.**
- **Upon having an impact on the tire, we recommend you to have the tires inspected by an authorized HYUNDAI dealer.**
- **Inspect the tires every 3,000 km to prevent damage.**

NOTICE

- **It is difficult to recognize tire damage only with eyes. However, we recommend you to have the tire checked or replaced upon detecting even the slightest tire damage. The tire damage may leak air from the tire.**
- **Tire damage, caused by driving on a rough road, pothole, manhole or curb stone, or off the road, is not covered by the manufacturer's warranty.**
- **For further information about the tire, refer to the label on the tire sidewall.**

FUSES

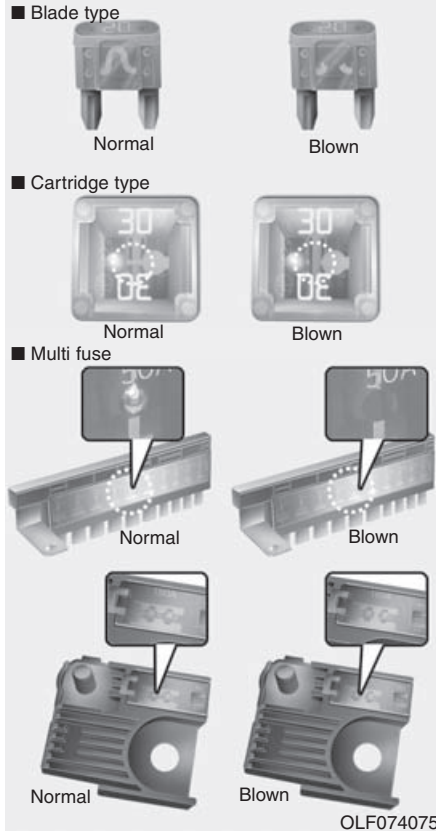

A vehicle's electrical system is protected from electrical overload damage by fuses.

This vehicle has 2 (or 3) fuse panels, one located in the driver's side panel bolster, the other in the engine compartment near the battery.

If any of your vehicle's lights, accessories, or controls do not work, check the appropriate circuit fuse. If a fuse has blown, the element inside the fuse will be melted.

If the electrical system does not work, first check the driver's side fuse panel. Before replacing a blown fuse, turn the engine and all switches off, and then disconnect the negative battery cable. Always replace a blown fuse with one of the same rating.

If the replacement fuse blows, this indicates an electrical problem. Avoid using the system involved and immediately consult an authorized HYUNDAI dealer.

i Information

Three kinds of fuses are used: blade type for lower amperage rating, cartridge type and multi fuse for higher amperage ratings.

⚠ WARNING**Fuse replacement**

- Never replace a fuse with anything but another fuse of the same rating.
- A higher capacity fuse could cause damage and possibly a fire.
- Never install a wire or aluminum foil instead of the proper fuse - even as a temporary repair. It may cause extensive wiring damage and a possible fire.

NOTICE

Do not use a screwdriver or any other metal object to remove fuses because it may cause a short circuit and damage the system.

NOTICE

- When replacing a blown fuse or relay with a new one, make sure the new fuse or relay fits tightly into the clips. The incomplete fastening fuse or relay may cause the vehicle wiring and electric systems damage and a possible fire.
- Do not remove fuses, relays and terminals fastened with bolts or nuts. The fuses, relays and terminals may be fastened incompletely, and it may cause a possible fire. If fuses, relays and terminals fastened with bolts or nuts are blown, we recommend that you consult an authorized HYUNDAI dealer.
- Do not input any other objects except fuses or relays into fuse/relay terminals such as a driver or wiring. It may cause contact failure and system malfunction.

Inner panel fuse replacement

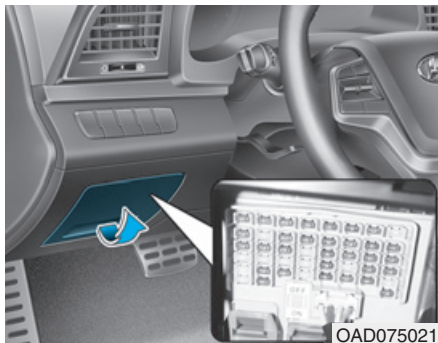

1. Turn the engine and all other switches off.
2. Open the fuse panel cover.

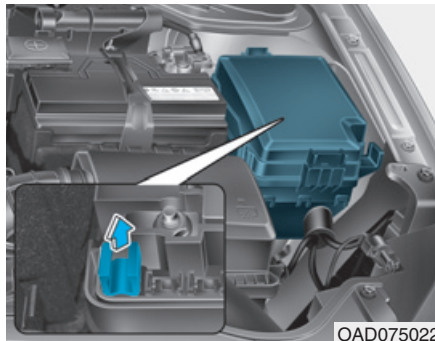

3. Pull the suspected fuse straight out. Use the removal tool provided in the engine compartment fuse panel.
4. Check the removed fuse; replace it if it is blown.
5. Push in a new fuse of the same rating, and make sure it fits tightly in the clips.

If it fits loosely, we recommend that you consult an authorized HYUNDAI dealer.

i Information

If you do not have a spare, use a fuse of the same rating from a circuit you may not need for operating the vehicle, such as the cigar lighter fuse.

If the headlights or other electrical components do not work and the fuses are OK, check the fuse block in the engine compartment. If a fuse is blown, it must be replaced with the same rating.

Fuse switch

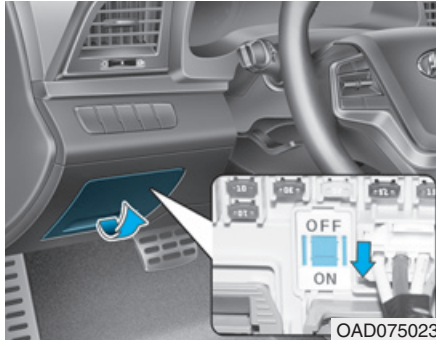

Always, place the fuse switch to the ON position.

If you move the switch to the OFF position, some items such as the audio system and digital clock must be reset and the smart key may not work properly.

i Information

■ Conventional cluster



■ Supervision cluster

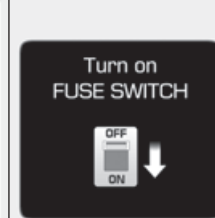

OAD045144/OTL045155L

If the fuse switch is OFF, the above message will appear.

NOTICE

- Always place the fuse switch in the ON position while driving the vehicle.
- Place the fuse switch in the OFF position when the vehicle is parked more than a month to prevent battery discharge.
- Do not move the transportation fuse switch repeatedly. The fuse switch may be damaged.

Engine compartment panel fuse replacement

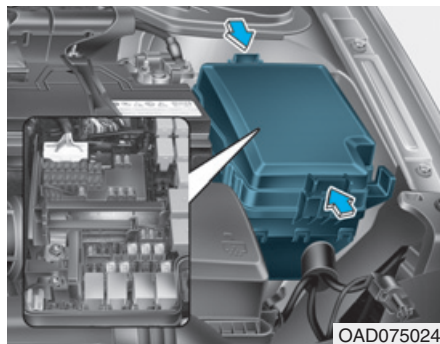

1. Turn the engine off and all other switches off.
2. Turn all the switches off.
3. Remove the fuse box cover by pressing the tap and pulling up.
4. Check the removed fuse; replace it if it is blown. To remove or insert the fuse, use the fuse puller in the engine compartment fuse panel.
5. Push in a new fuse of the same rating, and make sure it fits tightly in the clips. If it fits loosely, we recommend that you consult an authorized HYUNDAI dealer.

NOTICE

After checking the fuse box in the engine compartment, securely install the fuse box cover. If not, electrical failures may occur from water leaking in.

Main fuse

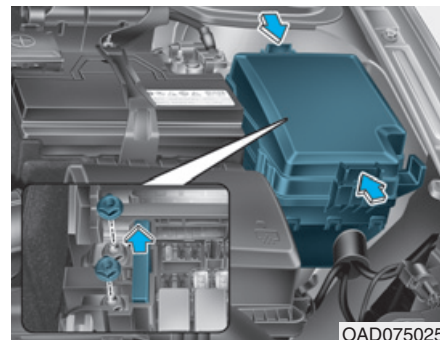

If an electrical system does not operate with no blown fuse in the engine room and inner fuse box, the main fuse inside the battery (+) cap may be blown.

The main fuse is heavily connected to many other parts. In this case, we recommend you to contact an authorized HYUNDAI dealer.

Multi fuse

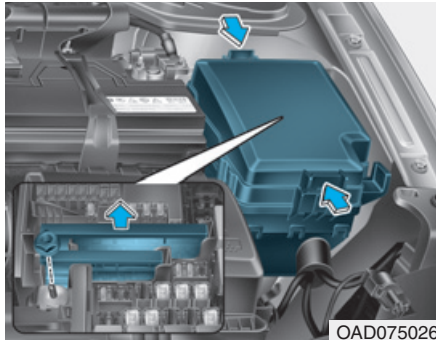

If the multi fuse is blown, it must be removed as follows:

1. Disconnect the negative battery cable.
2. Remove the nuts shown in the picture above.
3. Replace the fuse with a new one of the same rating.
4. Reinstall in the reverse order of removal.

i Information

If the multi fuse is blown, we recommend that you consult an authorized HYUNDAI dealer.

Blade type fuse

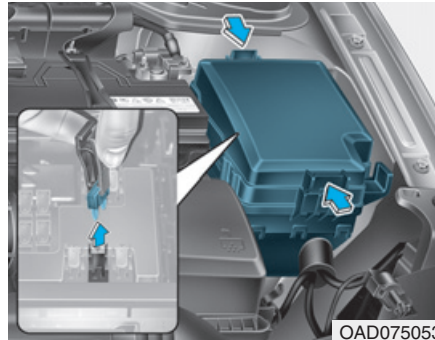





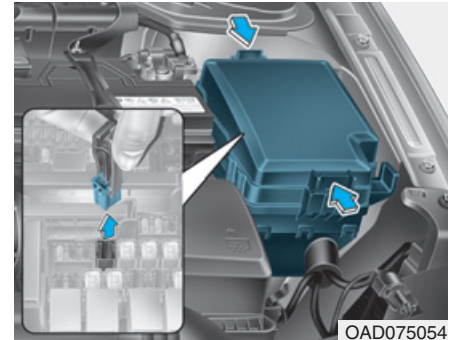

Before inspecting a fuse, you should turn OFF the engine as well as the other electric system switches. If a fuse is blown out, remove the blown-out fuse and install a new fuse of the same capacity by using the fuse puller, which is prepared inside the fuse box in the engine compartment. A new fuse may be prepared along with the fuse puller. However, if not, you may temporarily select/use a fuse of the other systems, which do not affect the vehicle operation, such as the audio system.

Cartridge type fuse







Before inspecting a fuse, you should turn OFF the engine as well as the other electric system switches. If a fuse is blown out, remove the blown-out fuse and install a new fuse of the same capacity. Pay extreme caution not to damage the blown-out fuse while removing it.





Driver's side fuse panel

Fuse Name	Symbol	Fuse rating	Circuit Protected
SPARE2	² SPARE	10A	Spare
CLUSTER	CLUSTER	10A	Instrument Cluster
A/BAG IND	^{IND} 	7.5A	Instrument Cluster, A/C Control Module
MDPS1	 1	7.5A	MDPS Unit
MODULE7	⁷ MODULE	7.5A	Front Seat Warmer Control Module, Front Air Ventilation Seat Control Module, Rear Seat Warmer Control Module, Sunroof Motor, Electro Chromic Mirror
A/CON1	¹ 	7.5A	E/R Junction Block (RLY.12, RLY.1B, RLY.13B), Ionizer, A/C Control Module
HTD STRG		15A	BCM
WIPER1	¹ 	25A	Wiper Motor, PCM Block (Front Wiper (Low) Relay)
HTD MIRR		10A	Driver Power Outside Mirror, Passenger Power Outside Mirror, A/C Control Module, ECM/PCM
DR LOCK		20A	Door Lock Relay, Door Unlock Relay
MULTI MEDIA	MULTI MEDIA	15A	DC-DC Converter, Audio, A/V & Navigation Head Unit, MTH E-Call Module
MODULE1	¹ MODULE	7.5A	Driver/Passenger Smart Key Outside Handle, Driver Door Module, Passenger Door Module







Driver's side fuse panel

Fuse Name	Symbol	Fuse rating	Circuit Protected
BUTTON START3	³ 	7.5A	Immobilizer Module, Smart Key Control Module
A/BAG		15A	SRS Control Module
MODULE6	⁶ MODULE	7.5A	Smart Key Control Module, BCM
WASHER		15A	Multifunction Switch
WIPER2	² 	10A	BCM, ECM/PCM
MEMORY1	¹ MEMORY	10A	Driver/Passenger Door Module, Driver IMS Module, BCM, Data Link Connector, Digital Clock, Rain Sensor, A/C Control Module, Instrument Cluster, ICM Relay Box (Outside Mirror Folding/Unfolding Relay)
MEMORY2	² MEMORY	7.5A	Not Used
SUNROOF		20A	Sunroof Motor
BRAKE SWITCH	BRAKE SWITCH	7.5A	Stop Lamp Switch, Smart Key Control Module
MODULE3	³ MODULE	10A	Stop Lamp Switch, BCM, Sport Mode Switch, Driver Door Module, Passenger Door Module
MODULE5	⁵ MODULE	10A	MTS E-Call Module, Crash Pad Switch, A/T Shift Lever Indicator, A/V &, Navigation Head Unit, A/C Control Module, Console Switch LH/RH, Head Lamp Leveling Device Actuator LH/RH, DC-DC Converter, Front Seat Warmer Control Module, Front Air Ventilation Seat Control Module, Rear Seat Warmer Control Module, Driver Ims Module

Driver's side fuse panel

Fuse Name	Symbol	Fuse rating	Circuit Protected
SPARE3	³ SPARE	15A	Spare
SPARE5	⁵ SPARE	25A	Spare
S/HEATER REAR	^{RR} 	25A	Rear Seat Warmer Control Module
AMP	AMP	25A	DC-DC Converter, AMP
SPARE4	⁴ SPARE	20A	Spare
BUTTON START2	² 	7.5A	Smart Key Control Module, Immobilizer Module
IG1	IG1	25A	PCB Block (Fuse : F9, F10B, F12, F13) E/R Junction Block (RLY.13A)
AEB	AEB	10A	Not Used
MODULE4	⁴ MODULE	10A	Parking Assist Buzzer, BCM, Blind Spot Detection Radar LH/RH
P/WDW RH	^{RH} 	25A	Power Window RH Rley Driver Safety Power Window Module (RHD)
TRUNK		10A	Trunk Relay, Trunk Lid Latch
P/SEAT DRV	^{DRV} 	30A	Driver Seat Manual Switch, Driver Seat Manual Switch, Driver Ims Module

Driver's side fuse panel

Fuse Name	Symbol	Fuse rating	Circuit Protected
S/HEATER FRONT	^{FRT} 	20A	Front Seat Warmer Control Module, Front Air Ventilation Seat Control Module
START		7.5A	Burglar Alarm Relay, Transmission Range Switch, Ignition Lock & Clutch Switch, Smart Key Control Module, ECM/PCM, E/R Junction Block (RLY.4)
BUTTON START1	¹ 	15A	Smart Key Control Module
A/CON2	² 	10A	E/R Junction Block (RLY.12), Blower Motor, Blower Resistor, A/C Control Module
SPARE1	¹ SPARE	20A	Spare
P/WDW LH	^{LH} 	25A	Power Window LH Relay Driver Safety Power Window Module (LHD)
INTERIOR LAMP		10A	Ignition Key ILL. & Door Warning Switch, Trunk Room Lamp, Front Vanity Lamp, LH/RH, Room Lamp, Overhead Console Lamp
MODULE2	² MODULE	10A	Digital Clock, USB Charging Connector, MTS E-Call Module, Smart Key Control, Module, BCM, Audio, A/V & Navigation Head Unit, Power Outside Mirror Switch, DC-DC Converter, AMP, E/R Junction Block (RLY.14)

Engine compartment fuse panel

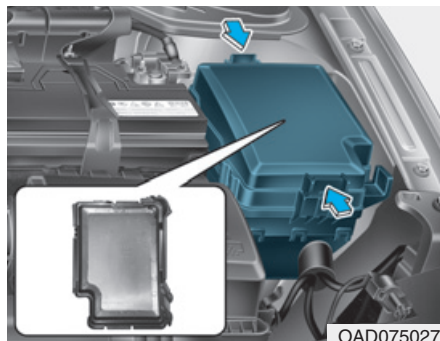









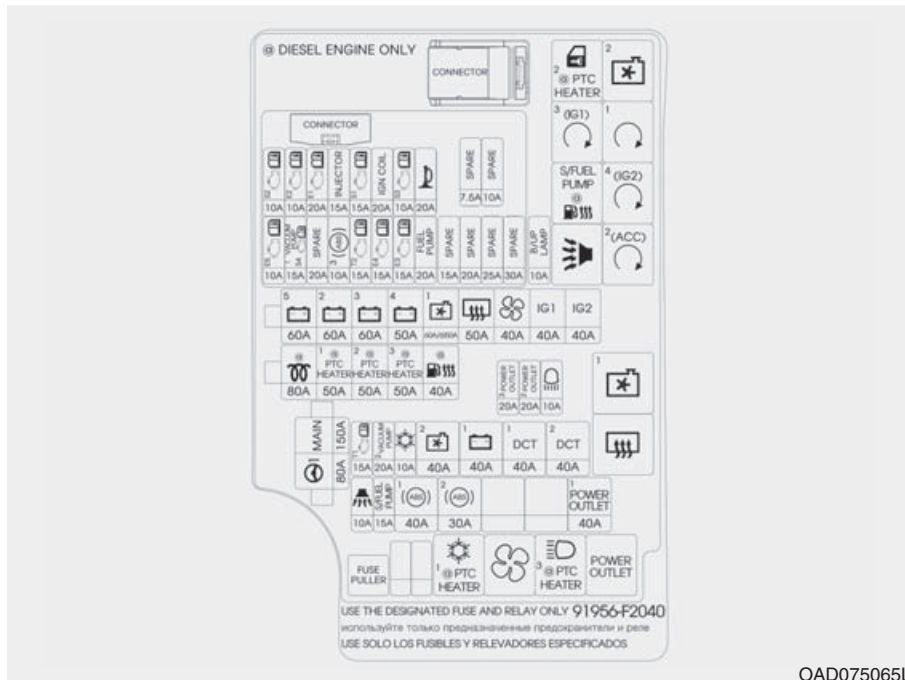

OAD075027



Inside the fuse/relay box covers, you can find the fuse/relay label describing fuse/relay name and capacity.

i Information

Not all fuse panel descriptions in this manual may be applicable to your vehicle. It is accurate at the time of printing. When you inspect the fuse box on your vehicle, refer to the fuse box label.







Symbol	Relay NO.	Relay Name	Type
² PTC HEATER	RLY. 1B	PTC HEATER #2 Relay	MICRO
² 	RLY. 2	COOLING FAN2 Relay	MICRO
³ (IG1) 	RLY. 3	PDM #3 (IG1) Relay	MICRO
¹ 	RLY. 4	START #1 Relay	MICRO
S/FUEL PUMP	RLY. 5A	SUB FUEL PUMP Relay	MICRO
	RLY. 5B	FUEL HEATER Relay (D4FB)	MICRO
⁴ (IG2) 	RLY. 6	PDM #4 (IG2) Relay	MICRO
	RLY. 7	B/ALARM HORN Relay	MICRO
² (ACC) 	RLY. 8	PDM #2 (ACC) Relay	MICRO
¹ 	RLY. 9	COOLING FAN1 Relay	MINI
	RLY. 10	REAR HEATED Relay	MINI
	RLY. 11A	A/C Relay	MICRO
¹ PTC HEATER	RLY. 11B	PTC HEATER #1 Relay (D4FB)	MICRO

Symbol	Relay NO.	Relay Name	Type
	RLY. 12	BLOWER Relay	MICRO
	RLY. 13A	H/LAMP HI Relay	MICRO
³ PTC HEATER	RLY. 13B	PTC HEATER #3 Relay (D4FB)	MICRO
POWER OUTLET	RLY. 14	POWER OUTLET Relay (D4FB)	MICRO





Engine compartment main fuse panel

Fuse Name	Symbol	Fuse rating	Circuit Protected
MAIN	MAIN	150A	Fuse : F28, F29, F30, F31, F34
MDPS1	 1	80A	MDPS Unit
BATT5	⁵ 	60A	PCB Block (Fuse : F8, F14, F15, F16, Engine Control Relay)
BATT2	² 	60A	Smart Junction Block (Fuse : F36, ARISU)
BATT3	³ 	60A	Smart Junction Block (Fuse : ARISU, IPS)
BATT4	⁴ 	50A	Smart Junction Block (Fuse : F20, F26, F27, F33, F34, F35, F41)
COOLING FAN1	¹ 	50A	RLY.9, RLY.2 (DSL)
RR HTD		50A	RLY.10
BLOWER		40A	RLY.12
IG1	IG1	40A	Ignition Switch, E/R Junction Block (RLY.3, RLY8)
IG2	IG2	40A	Ignition Switch, E/R Junction Block (RLY.6)
GLOW		80A	Glow Relay Unit













Engine compartment main fuse panel

Fuse Name	Symbol	Fuse rating	Circuit Protected
PTC HEATER1	¹ PTC HEATER	50A	RLY.11B
PTC HEATER2	² PTC HEATER	50A	RLY.1B
PTC HEATER3	³ PTC HEATER	50A	RLY.13B
FUEL HEATER		40A	RLY.5B
B/UP LAMP	B/UP LAMP	10A	Electro Chromic Mirror, Rear Combination Lamp (IN) LH/RH, Audio, MTS E-Call Module, Smart Junction Block (IPS Control Module)
POWER OUTLET3	³ POWER OUTLET	20A	Cigarette Lighter
POWER OUTLET2	² POWER OUTLET	20A	Power Outlet
HEAD LAMP HI		20A	RLY.13A
TCU1	^{T1} 	15A	TCM
VACUUM PUMP1	¹ VACUUM PUMP	20A	Net Used
A/CON		10A	Net Used
COOLING FAN2	² 	40A	RLY.9, RLY.2 (GSL)













Engine compartment main fuse panel

Fuse Name	Symbol	Fuse rating	Circuit Protected
BATT1	¹ 	40A	Smart Junction Block (LEAK CURRENT AUTOCUT DEVICE, Fuse : F10, F12, F21, F29, F38)
DCT1	¹ DCT	40A	TCM
DCT2	² DCT	40A	TCM
B/ALARM HORN		10A	RLY.7
S/FUEL PUMP	S/FUEL PUMP	15A	RLY.5
ABS1	¹ 	40A	ABS Control Module, ESC Control Module, Multipurpose Check Connector
ABS2	² 	30A	ABS Control Module, ESC Control Module, Multipurpose Check Connector
POWER	¹ POWER OUTLET	40A	RLY.14











Engine compartment main fuse panel - PCB Block (Gamma 1.6 MPI)

Fuse Name	Symbol	Fuse rating	Circuit Protected
SNSR2		10A	Purge Control Solenoid Valve, Variable Intake Solenoid Valve, E/R Junction Block (RLY.2, RLY.9)
ECU2		15A	-
ECU1		10A	ECM/PCM
INJ.	INJECTOR	15A	INJECTOR #1~#4
SNSR1		15A	Oxygen Sensor (Up), Oxygen Sensor (Down)
IGN.	IGN COIL	15A	Ignition Coil #1~#4, Condenser
SNSR3		20A	Fuel Pump Relay, Oil Control Valve #1, Oil Control Valve #2
HORN		10A	Horn Relay
ECU5		10A	ECM/PCM
SNSR4		20A	-
ABS3		15A	ABS/ESC Control Module, Multipurpose Check Connector
TCU2		15A	Vehicle Speed Sensor, Transmission Range Switch, E/R Junction Block (Fuse : F17)
ECU4		20A	ECM/PCM
ECU3		10A	ECM/PCM
F/PUMP	FUEL PUMP	20A	Fuel Pump Relay



Engine compartment main fuse panel - PCB Block (Nu 2.0 MPI)

Fuse Name	Symbol	Fuse rating	Circuit Protected
SNSR2		10A	Purge Control Solenoid Valve, Variable Intake Solenoid Valve, E/R Junction Block (RLY.2, RLY.9), Cold Start Solenoid Valve
ECU2		15A	PCM
ECU1		10A	-
INJ.	INJECTOR	15A	INJECTOR #1~#4
SNSR1		15A	Oxygen Sensor (Up), Oxygen Sensor (Down)
IGN.	IGN COIL	15A	Ignition Coil #1~#4, Condenser
SNSR3		20A	Fuel Pump Relay, Oil Control Valve #1, Oil Control Valve #2
HORN		10A	Horn Relay
ECU5		10A	PCM
SNSR4		20A	-
ABS3		15A	ABS/ESC Control Module, Multipurpose Check Connector
TCU2		15A	Vehicle Speed Sensor, Transmission Range Switch, E/R Junction Block (Fuse : F17)
ECU4		20A	PCM
ECU3		10A	PCM
F/PUMP	FUEL PUMP	20A	Fuel Pump Relay

Engine compartment main fuse panel - PCB Block (UII 1.6 TCI)

Fuse Name	Symbol	Fuse rating	Circuit Protected
SNSR2		10A	Electronic Vgt Actuator, Egr Cooling Bypass Solenoid Valve, Stop Lamp Switch, Pm (Particulate Matter) Sensor, Fuel Pressure Regulating Valve, Rail Pressure Regulating Valve, E/R Junction Block (RLY.2, RLY.9, RLY.5B, RLY.11B)
ECU2		15A	-
ECU1		10A	ECM
INJ.	INJECTOR	15A	-
SNSR1		15A	Lambda Sensor #1, Lambda Sensor #2
IGN.	IGN COIL	15A	-
SNSR3		20A	Fuel Pump Relay, Air Flow Sensor, Camshaft Position Sensor, Oil Control Valve
HORN		10A	Horn Relay
ECU5		10A	ECM
SNSR4		20A	Fuel Filter Warning Sensor, Glow Relay Unit
ABS3		15A	ABS/ESC Control Module, Multipurpose Check Connector
TCU2		15A	TCM, Transmission Range Switch

Engine compartment main fuse panel - PCB Block (UII 1.6 TCI)

Fuse Name	Symbol	Fuse rating	Circuit Protected
ECU4		20A	-
ECU3		10A	ECM
F/PUMP		20A	Fuel Pump Relay

LIGHT BULBS

Consult an authorized HYUNDAI dealer to replace most vehicle light bulbs. It is difficult to replace vehicle light bulbs because other parts of the vehicle must be removed before you can get to the bulb. This is especially true for removing the headlamp assembly to get to the bulb(s).

Removing/installing the headlamp assembly can result in damage to the vehicle.

WARNING

Prior to working on the light, firmly apply the parking brake, ensure that the ignition switch is in the LOCK/OFF position and turn off the lights to avoid sudden movement of the vehicle and burning your fingers or receiving an electric shock.

NOTICE

Be sure to replace the burned-out bulb with one of the same wattage rating. Otherwise, it may cause damage to the fuse or electric wiring system.

CAUTION

If you don't have necessary tools, the correct bulbs and the expertise, consult an authorized HYUNDAI dealer. In many cases, it is difficult to replace vehicle light bulbs because other parts of the vehicle must be removed before you can get to the bulb. This is especially true if you have to remove the headlamp assembly to get to the bulb(s).

Removing/installing the headlamp assembly can result in damage to the vehicle.

i Information

After heavy driving, rain or washing, headlamp and tail lamp lenses could appear frosty. This condition is caused by the temperature difference between the lamp inside and outside.

This is similar to the condensation on your windows inside your vehicle during the rain and doesn't indicate a problem with your vehicle. If the water leaks into the lamp bulb circuitry, we recommend that the system be checked by an authorized HYUNDAI dealer.

i Information (For Europe)

The low beam light distribution is asymmetric. If you go abroad to a country with opposite traffic direction, this asymmetric part will dazzle oncoming car driver. To prevent dazzle, ECE regulation demand several technical solutions (ex. automatic change system, adhesive sheet, down aiming). These headlamps are designed not to dazzle opposite drivers. So, you need not change your headlamps in a country with opposite traffic direction.

Headlamp, position lamp, turn signal lamp and fog lamp light bulb replacement

Type A – Standard



- (1) Headlamp (Low)
- (2) Headlamp (High)
- (3) Turn signal lamp
- (4) Position lamp
- (5) Daytime running lamp (DRL)
- (6) Fog lamp (if equipped)



Headlamp (Halogen bulb)

WARNING

- **Handle halogen bulbs with care. Halogen bulbs contain pressurized gas that will produce flying pieces of glass that could cause injuries if broken.**
- **Wear eye protection when changing a bulb. Allow the bulb to cool down before handling it.**

- Always handle them carefully, and avoid scratches and abrasions. If the bulbs are lit, avoid contact with liquids.
- Never touch the glass with bare hands. Residual oil may cause the bulb to overheat and burst when lit.
- A bulb should be operated only when installed in a headlamp.
- If a bulb becomes damaged or cracked, replace it immediately and carefully dispose of it.

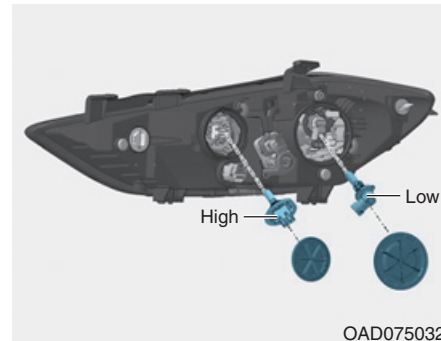

1. Open the hood.
2. Disconnect the negative battery cable.
3. Remove the headlamp bulb cover by turning it counterclockwise.
4. Disconnect the headlamp bulb socket-connector.
5. Unsnap the headlamp bulb retaining wire by pressing the end and pushing it upward.
6. Remove the bulb from the headlamp assembly.
7. Install a new headlamp bulb and snap the headlamp bulb retaining wire into position by aligning the wire with the groove on the bulb.

8. Connect the headlamp bulb socket-connector.
9. Install the headlamp bulb cover by turning it clockwise.

i Information

The headlamp aiming should be adjusted after an accident or after the headlamp assembly is reinstalled at an authorized HYUNDAI dealer.

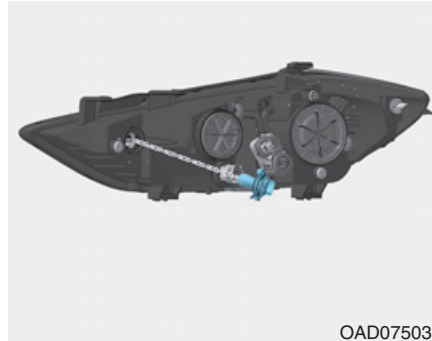

Turn signal lamp

1. Open the hood.
2. Disconnect the negative battery cable.
3. Remove the socket from the assembly by turning the socket counterclockwise until the tabs on the socket align with the slots on the assembly.
4. Remove the bulb from the socket by pressing it in and rotating it counterclockwise until the tabs on the bulb align with the slots in the socket. Pull the bulb out of the socket.

5. Insert a new bulb by inserting it into the socket and rotating it until it locks into place.
6. Install the socket in the assembly by aligning the tabs on the socket with the slots in the assembly.
7. Push the socket into the assembly and turn the socket clockwise.

Daytime running lamp/ Position lamp/Fog lamp

If the LED lamp does not operate, we recommend that the system be checked by an authorized HYUNDAI dealer.

Type B - LED Daytime running lamp



- (1) Headlamp (Low)
- (2) Headlamp (High)
- (3) Turn signal lamp
- (4) Position lamp/
Daytime running lamp (DRL)
- (5) Fog lamp

Type C - HID headlamp



- (1) Headlamp (Low)
- (2) Headlamp (High)
- (3) Turn signal lamp
- (4) Position lamp/
Daytime running lamp (DRL)
- (5) Fog lamp

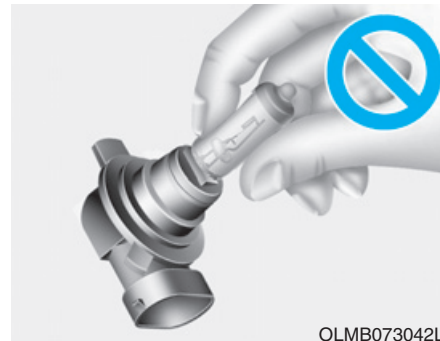

OLMB073042L

Halogen Headlamp (Type B Low/High, Type C High)

WARNING

- **Handle halogen bulbs with care. Halogen bulbs contain pressurized gas that will produce flying pieces of glass that could cause injuries if broken.**
- **Wear eye protection when changing a bulb. Allow the bulb to cool down before handling it.**

- Always handle them carefully, and avoid scratches and abrasions. If the bulbs are lit, avoid contact with liquids.
- Never touch the glass with bare hands. Residual oil may cause the bulb to overheat and burst when lit.
- A bulb should be operated only when installed in a headlamp.
- If a bulb becomes damaged or cracked, replace it immediately and carefully dispose of it.

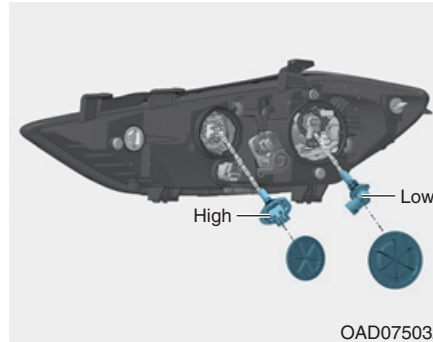

1. Open the hood.
2. Disconnect the negative battery cable.
3. Remove the headlamp bulb cover by turning it counterclockwise.
4. Disconnect the headlamp bulb socket-connector.
5. Unsnap the headlamp bulb retaining wire by pressing the end and pushing it upward.
6. Remove the bulb from the headlamp assembly.
7. Install a new headlamp bulb and snap the headlamp bulb retaining wire into position by aligning the wire with the groove on the bulb.

8. Connect the headlamp bulb socket-connector.
9. Install the headlamp bulb cover by turning it clockwise.

i Information

The headlamp aiming should be adjusted after an accident or after the headlamp assembly is reinstalled at an authorized HYUNDAI dealer.

HID Headlamp (Type C Low)

If the HID lamp does not operate, we recommend that the system be checked by an authorized HYUNDAI dealer.

WARNING

HID Headlight low beam (if equipped)

Do not attempt to replace or inspect the low beam (XENON bulb) due to electric shock danger. If the low beam (XENON bulb) is not working, we recommend that the system be checked by an authorized HYUNDAI dealer.

Information

HID lamps have superior performance vs. halogen bulbs.

HID lamps are estimated by the manufacturer to last twice as long or longer than halogen bulbs depending on their frequency of use. They will probably require replacement at some point in the life of the vehicle. Cycling the headlamps on and off more than typical use will shorten HID lamps life. HID lamps do not fail in the same manner as halogen incandescent lamps. If a headlamp goes out after a period of operation but will immediately relight when the headlamp switch is cycled it is likely the HID lamp needs to be replaced. HID lighting components are more complex than conventional halogen bulbs thus have higher replacement cost.

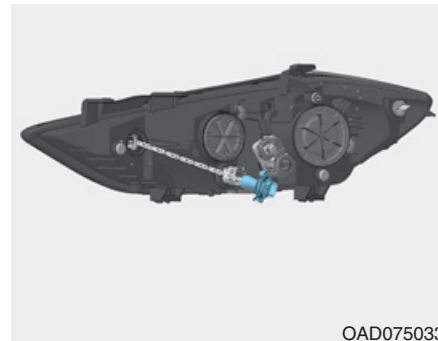

OAD075033

Turn signal lamp

1. Open the hood.
2. Disconnect the negative battery cable.
3. Remove the socket from the assembly by turning the socket counterclockwise until the tabs on the socket align with the slots on the assembly.
4. Remove the bulb from the socket by pressing it in and rotating it counterclockwise until the tabs on the bulb align with the slots in the socket. Pull the bulb out of the socket.

5. Insert a new bulb by inserting it into the socket and rotating it until it locks into place.
6. Install the socket in the assembly by aligning the tabs on the socket with the slots in the assembly.
7. Push the socket into the assembly and turn the socket clockwise.

Daytime running lamp/ Position lamp/Fog lamp

If the LED lamp does not operate, we recommend that the system be checked by an authorized HYUNDAI dealer.

Side repeater lamp replacement

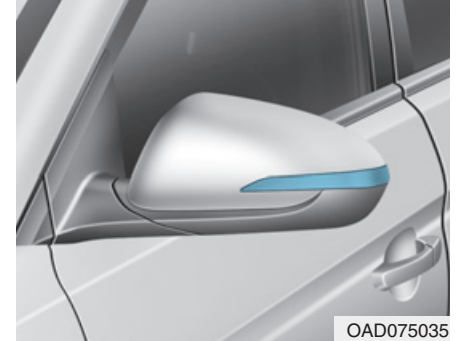

If the LED lamp does not operate, have the vehicle checked by an authorized HYUNDAI dealer.

Headlamp and front fog lamp aiming (For Europe)

Headlamp aiming

■ without Headlight leveling device

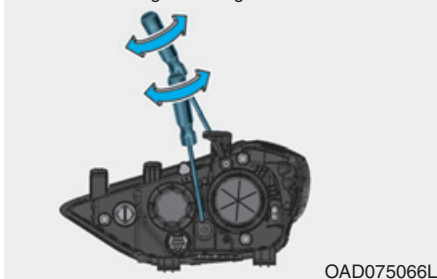

■ Equipped with Headlight leveling device

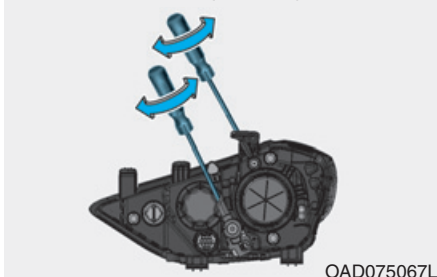

1. Inflate the tires to the specified pressure and remove any loads from the vehicle except the driver, spare tire, and tools.
2. The vehicle should be placed on a flat floor.
3. Draw vertical lines (Vertical lines passing through respective head lamp centers) and a horizontal line (Horizontal line passing through center of head lamps) on the screen.
4. With the headlamp and battery in normal condition, aim the headlamps so the brightest portion falls on the horizontal and vertical lines.
5. To aim the low beam left or right, turn the driver clockwise or counterclockwise. To aim the low beam up or down, turn the driver clockwise or counterclockwise.
To aim the high beam up or down, turn the driver clockwise or counterclockwise.

Front fog lamp aiming

The front fog lamp can be aimed in the same manner as the headlamps.

With the front fog lamps and battery in normal condition, aim the front fog lamps.

To aim the front fog lamp up or down, turn the driver clockwise or counterclockwise.

Aiming point

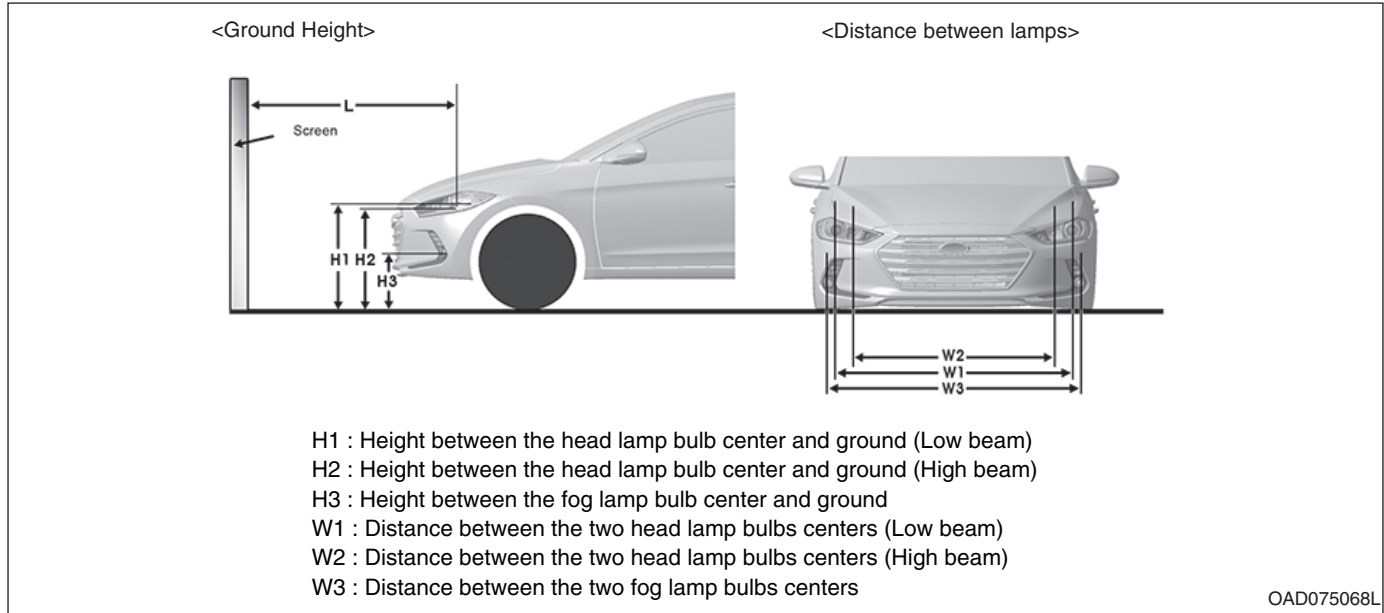

Unit: mm (in)

Vehicle condition	H1	H2	H3	W1	W2	W3
Without driver	685 (26.97)	662 (26.06)	356 (14.02)	1,466 (57.72)	1,242 (48.90)	1,565 (61.61)
With driver	678 (26.69)	655 (25.79)	350 (13.78)	1,466 (57.72)	1,242 (48.90)	1,565 (61.61)

Headlamp low beam (LHD side)

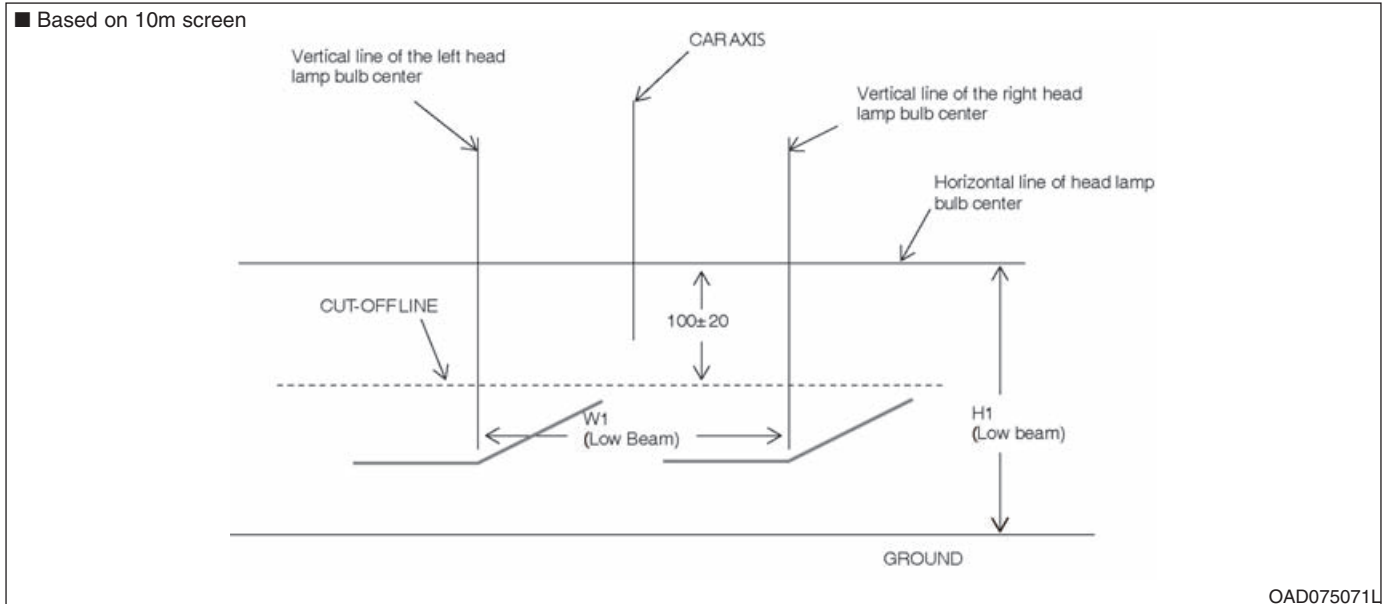

1. Turn the low beam on without driver aboard.
2. The cut-off line should be projected in the cut-off line shown in the picture.
3. When aiming the low beam, vertical aiming should be adjusted after adjusting the horizontal aiming.
4. If headlamp leveling device is equipped, adjust the head lamp leveling device switch with 0 positions.

Headlamp low beam (RHD side)

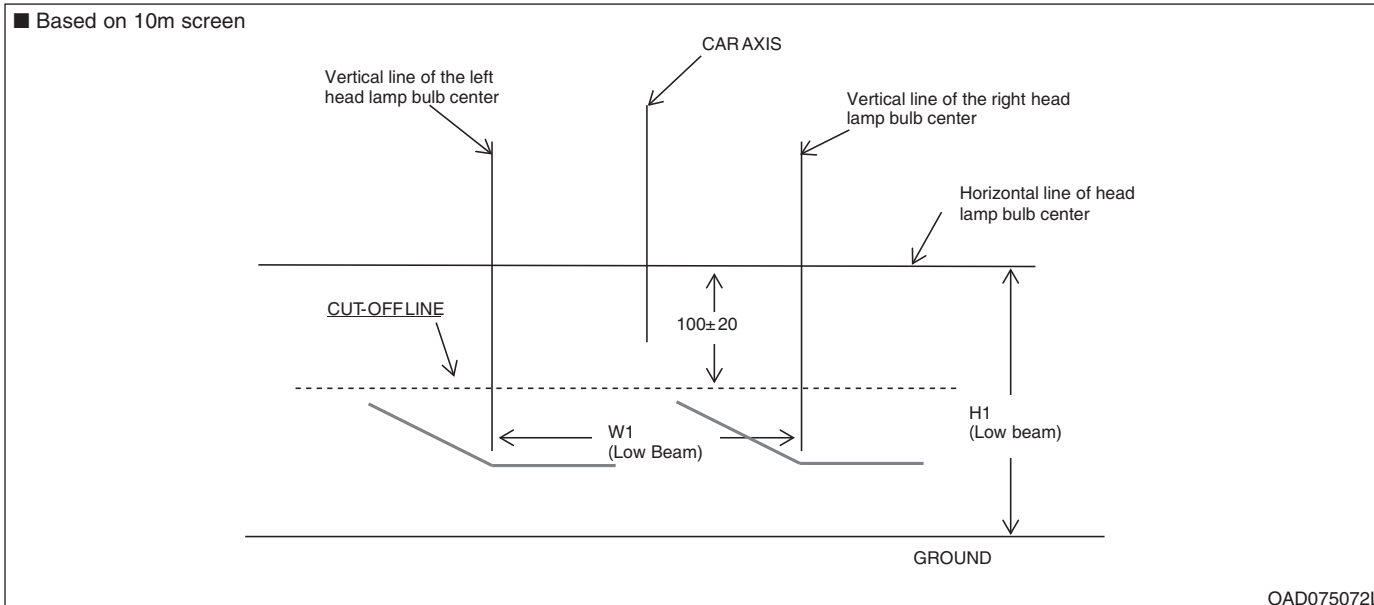

1. Turn the low beam on without driver aboard.
2. The cut-off line should be projected in the cut-off line shown in the picture.
3. When aiming the low beam, vertical aiming should be adjusted after adjusting the horizontal aiming.
4. If headlamp leveling device is equipped, adjust the head lamp leveling device switch with 0 positions.

Front fog lamp

■ Based on 10m screen

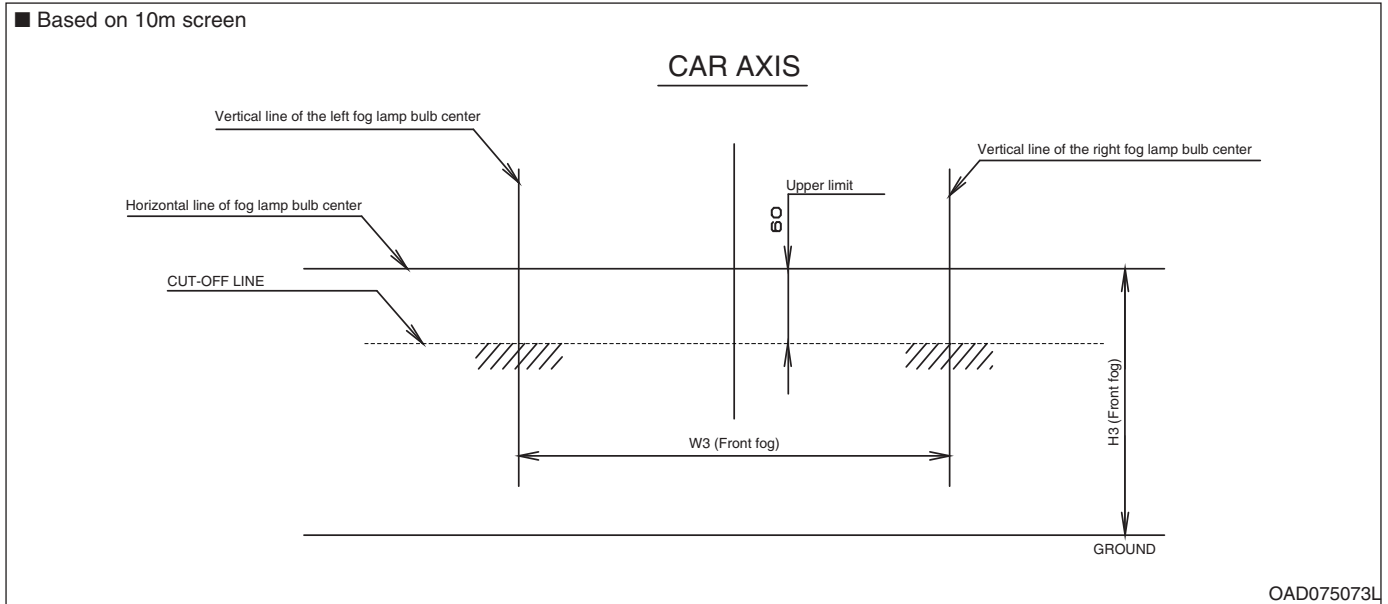

1. Turn the front fog lamp on without the driver aboard.
2. The cut-off line should be projected in the allowable range (shaded region).

Rear combination lamp bulb replacement

■ Type A (Bulb)

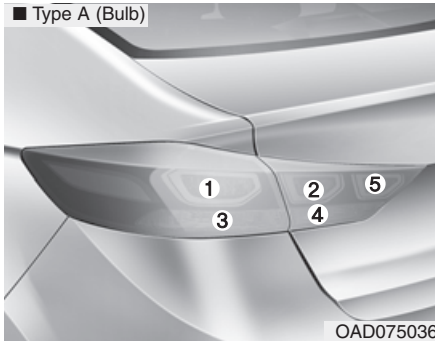

■ Type B (LED)

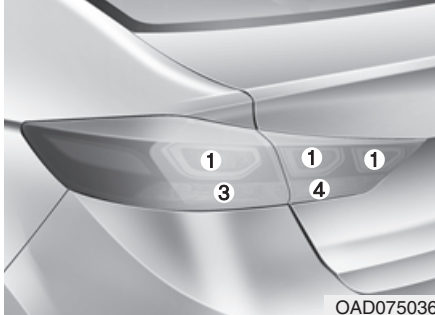

■ Type C (LED with fog lamp)

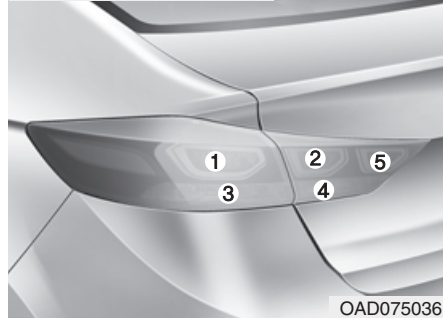

- (1) Tail/Stop lamp
- (2) Tail lamp
- (3) Turn signal lamp
- (4) Back-up lamp
- (5) Fog lamp (if equipped)

Outside lamp

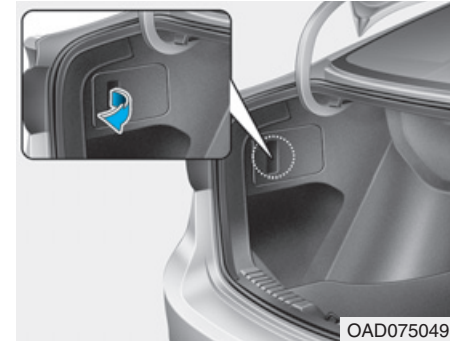

1. Open the trunk lid.
2. Remove the service cover by pulling out the service cover.

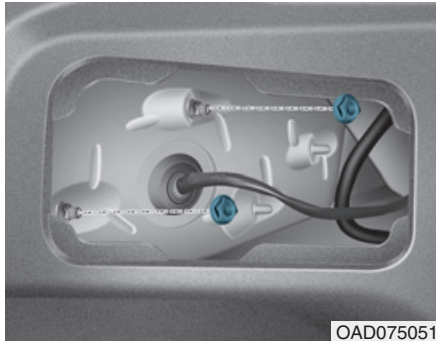

3. Loosen the assembly retaining nuts.

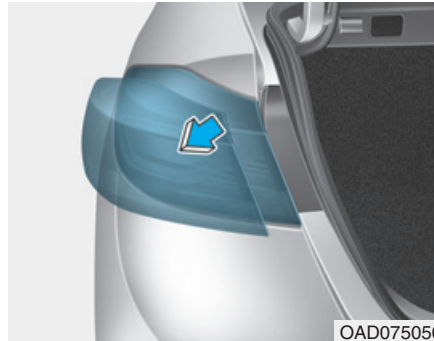

4. Remove the rear combination light assembly from the body of the vehicle.

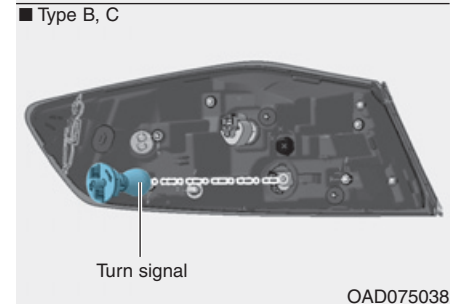
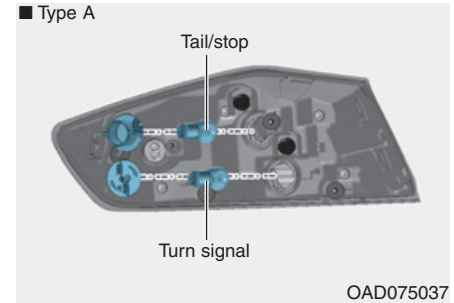

Stop/Tail lamp and turn signal lamp

5. Remove the socket from the assembly by turning the socket counterclockwise until the tabs on the socket align with the slots on the assembly.

6. Remove the bulb from the socket by pressing it in and rotating it counterclockwise until the tabs on the bulb align with the slots in the socket. Pull the bulb out of the socket.
7. Insert a new bulb by inserting it into the socket and rotating it until it locks into place.
8. Install the socket in the assembly by aligning the tabs on the socket with the slots in the assembly. Push the socket into the assembly and turn the socket clockwise.

Inside lamp

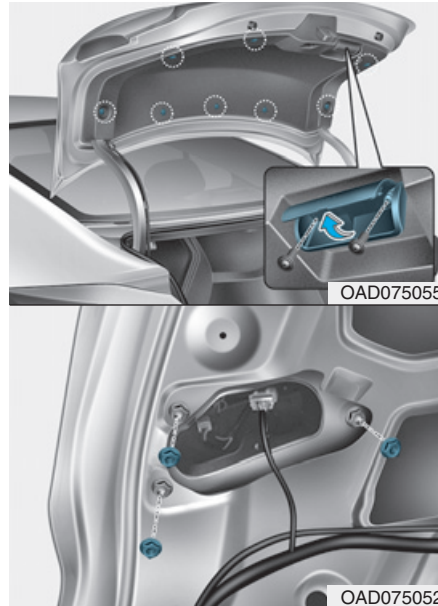

1. Open the trunk.
2. Loosen the retaining screw of the trunk lid cover and then remove the cover.
3. Disconnect the connector and then remove the nuts by turning the nuts counter clockwise.

Back up lamp

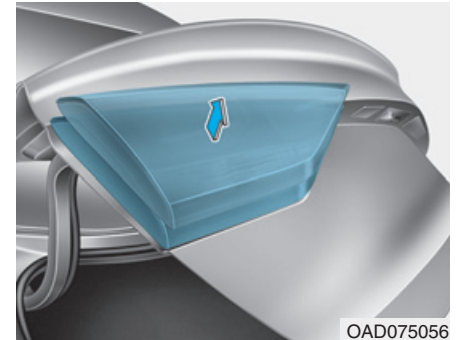

1. Take the light assembly out.

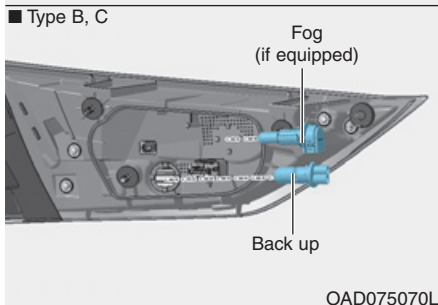
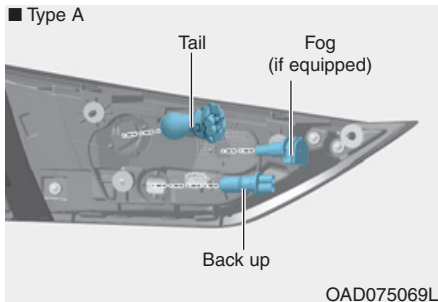

2. Remove the socket from the assembly by turning the socket counterclockwise until the tabs on the socket align with the slots on the assembly.
3. Remove the bulb by pulling it out
4. Insert a new bulb by inserting it into the socket.

5. Install the light assembly to the trunk.
6. Reinstall the nuts and connector and then the trunk lid cover by pushing in the screw.

Tail and rear fog lamp (if equipped)

4. Remove the socket from the assembly by turning the socket counterclockwise until the tabs on the socket align with the slots on the assembly.
5. Remove the bulb from the socket by pressing it in and rotating it counterclockwise until the tabs on the bulb align with the slots in the socket. Pull the bulb out of the socket.
6. Insert a new bulb by inserting it into the socket and rotating it until it locks into place.
7. Install the socket in the assembly by aligning the tabs on the socket with the slots in the assembly. Push the socket into the assembly and turn the socket clockwise.

High mounted stop lamp replacement

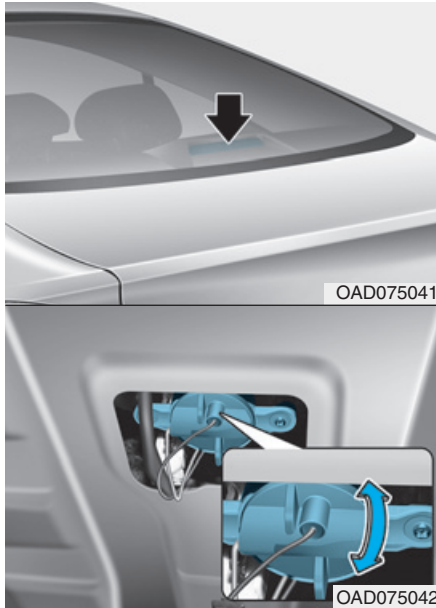

1. Open the trunk.
2. Remove the socket by turning it counterclockwise until the tabs on the socket align with the slots.

3. Remove the bulb from the socket by pressing it in and rotating it counterclockwise until the tabs on the bulb align with the slots in the socket. Pull the bulb out of the socket.
4. Insert a new bulb by inserting it into the socket and rotating it until it locks into place.
5. Install the socket in the assembly by aligning the tabs on the socket with the slots in the assembly. Push the socket into the assembly and turn the socket clockwise.

License plate light bulb replacement

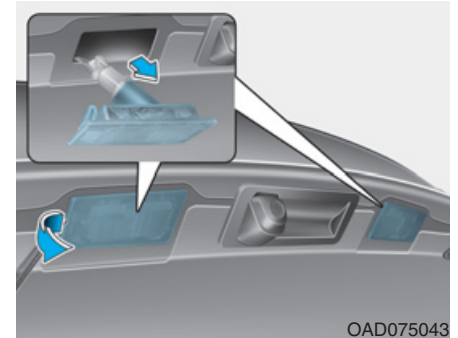

1. Remove the cover by pressing it as direction of the arrows.
2. Remove the bulb by pulling it straight out.
3. Install a new bulb.
4. Reinstall in the reverse order.

Interior light bulb replacement

■ Map lamp



■ Room lamp

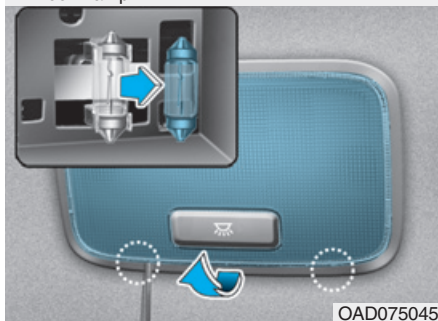

■ Luggage room lamp

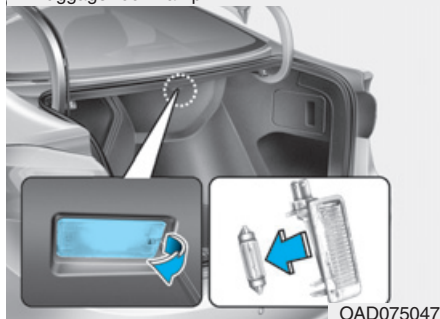

■ Sunvisor lamp



1. Using a flat-blade screwdriver, gently pry the lens from the interior light housing.
2. Remove the bulb by pulling it straight out.

⚠ WARNING

Prior to working on the Interior Lights, ensure that the “OFF” button is depressed to avoid burning your fingers or receiving an electric shock.

3. Install a new bulb in the socket.
4. Align the lens tabs with the interior light housing notches and snap the lens into place.

⚠ CAUTION

Use care not to dirty or damage lens, lens tab, and plastic housings.

APPEARANCE CARE

Exterior care

Exterior general caution

It is very important to follow the label directions when using any chemical cleaner or polish. Read all warning and caution statements that appear on the label.

High-pressure washing

- When using high-pressure washers, make sure to maintain sufficient distance from the vehicle. Insufficient clearance or excessive pressure can lead to component damage or water penetration.
- Do not spray the camera, sensors or its surrounding area directly with a high pressure washer. Shock applied from high pressure water may cause the device to not operate normally.
- Do not bring the nozzle tip close to boots (rubber or plastic covers) or connectors as they may be damaged if they come into contact with high pressure water.

Finish maintenance

Washing

To help protect your vehicle's finish from rust and deterioration, wash it thoroughly and frequently at least once a month with lukewarm or cold water.

If you use your vehicle for off-road driving, you should wash it after each off-road trip. Pay special attention to the removal of any accumulation of salt, dirt, mud, and other foreign materials. Make sure the drain holes in the lower edges of the doors and rocker panels are kept clear and clean.

Insects, tar, tree sap, bird droppings, industrial pollution and similar deposits can damage your vehicle's finish if not removed immediately. Even prompt washing with plain water may not completely remove all these deposits.

A mild soap, safe for use on painted surfaces, may be used. After washing, rinse the vehicle thoroughly with lukewarm or cold water. Do not allow soap to dry on the finish.

NOTICE

- **Do not use strong soap, chemical detergents or hot water, and do not wash the vehicle in direct sunlight or when the body of the vehicle is warm.**
- **Be careful when washing the side windows of your vehicle. Especially, with high-pressure water, water may leak through the windows and wet the interior.**
- **To prevent damage to the plastic parts and lamps, do not clean with chemical solvents or strong detergents.**

⚠ WARNING

Wet brakes

After washing the vehicle, test the brakes while driving slowly to see if they have been affected by water. If braking performance is impaired, dry the brakes by applying them lightly while maintaining a slow forward speed.



NOTICE

- Water washing in the engine compartment including high pressure water washing may cause the failure of electrical circuits located in the engine compartment.
- Never allow water or other liquids to come in contact with electrical/electronic components inside the vehicle as this may damage them.

Waxing

Wax the vehicle when water will no longer bead on the paint. Always wash and dry the vehicle before waxing. Use a good quality liquid or paste wax, and follow the manufacturer's instructions. Wax all metal trim to protect it and to maintain its luster. Removing oil, tar, and similar materials with a spot remover will usually strip the wax from the finish. Be sure to re-wax these areas even if the rest of the vehicle does not yet need waxing.

NOTICE

- Wiping dust or dirt off the body with a dry cloth will scratch the finish.
- Do not use steel wool, abrasive cleaners, or strong detergents containing highly alkaline or caustic agents on chrome-plated or anodized aluminum parts. This may result in damage to the protective coating and cause discoloration or paint deterioration.

Finish damage repair

Deep scratches or stone chips in the painted surface must be repaired promptly. Exposed metal will quickly rust and may develop into a major repair expense.

NOTICE

If your vehicle is damaged and requires any metal repair or replacement, be sure the body shop applies anti-corrosion materials to the parts repaired or replaced.

Bright-metal maintenance

- To remove road tar and insects, use a tar remover, not a scraper or other sharp object.
- To protect the surfaces of bright-metal parts from corrosion, apply a coating of wax or chrome preservative and rub to a high luster.
- During winter weather or in coastal areas, cover the bright metal parts with a heavier coating of wax or preservative. If necessary, coat the parts with non-corrosive petroleum jelly or other protective compound.

Underbody maintenance

Corrosive materials used for ice and snow removal and dust control may collect on the underbody. If these materials are not removed, accelerated rusting can occur on underbody parts such as the fuel lines, frame, floor pan and exhaust system, even though they have been treated with rust protection.

Thoroughly flush the vehicle underbody and wheel openings with lukewarm or cold water once a month, after off-road driving and at the end of each winter. Pay special attention to these areas because it is difficult to see all the mud and dirt. It will do more harm than good to wet down the road grime without removing it. The lower edges of doors, rocker panels, and frame members have drain holes that should not be allowed to clog with dirt; trapped water in these areas can cause rusting.

⚠ WARNING

After washing the vehicle, test the brakes while driving slowly to see if they have been affected by water. If braking performance is impaired, dry the brakes by applying them lightly while maintaining a slow forward speed.

Aluminum wheel maintenance

The aluminum wheels are coated with a clear protective finish.

NOTICE

- Do not use any abrasive cleaner, polishing compound, solvent, or wire brushes on aluminum wheels.
- Clean the wheel when it has cooled.
- Use only a mild soap or neutral detergent, and rinse thoroughly with water. Also, be sure to clean the wheels after driving on salted roads.
- Do not wash the wheels with high-speed car wash brushes.
- Do not use any cleanser containing acid or alkaline detergents.

Corrosion protection

Protecting your vehicle from corrosion

By using the most advanced design and construction practices to combat corrosion, we produce cars of the highest quality. However, this is only part of the job. To achieve the long-term corrosion resistance your vehicle can deliver, the owner's cooperation and assistance is also required.

Common causes of corrosion

The most common causes of corrosion on your car are:

- Road salt, dirt and moisture that is allowed to accumulate underneath the car.
- Removal of paint or protective coatings by stones, gravel, abrasion or minor scrapes and dents which leave unprotected metal exposed to corrosion.

High-corrosion areas

If you live in an area where your car is regularly exposed to corrosive materials, corrosion protection is particularly important. Some of the common causes of accelerated corrosion are road salts, dust control chemicals, ocean air and industrial pollution.

Moisture breeds corrosion

Moisture creates the conditions in which corrosion is most likely to occur. For example, corrosion is accelerated by high humidity, particularly when temperatures are just above freezing. In such conditions, the corrosive material is kept in contact with the car surfaces by moisture that is slow to evaporate.

Mud is particularly corrosive because it is slow to dry and holds moisture in contact with the vehicle. Although the mud appears to be dry, it can still retain the moisture and promote corrosion.

High temperatures can also accelerate corrosion of parts that are not properly ventilated so the moisture can be dispersed. For all these reasons, it is particularly important to keep your car clean and free of mud or accumulations of other materials. This applies not only to the visible surfaces but particularly to the underside of the car.

To help prevent corrosion

You can help prevent corrosion from getting started by observing the following:

Keep your car clean

The best way to prevent corrosion is to keep your car clean and free of corrosive materials. Attention to the underside of the car is particularly important.

- If you live in a high-corrosion area — where road salts are used, near the ocean, areas with industrial pollution, acid rain, etc.—, you should take extra care to prevent corrosion. In winter, hose off the underside of your car at least once a month and be sure to clean the underside thoroughly when winter is over.
- When cleaning underneath the car, give particular attention to the components under the fenders and other areas that are hidden from view. Do a thorough job; just dampening the accumulated mud rather than washing it away will accelerate corrosion rather than prevent it. Water under high pressure and steam are particularly effective in removing accumulated mud and corrosive materials.

- When cleaning lower door panels, rocker panels and frame members, be sure that drain holes are kept open so that moisture can escape and not be trapped inside to accelerate corrosion.

Keep your garage dry

Don't park your car in a damp, poorly ventilated garage. This creates a favorable environment for corrosion. This is particularly true if you wash your car in the garage or drive it into the garage when it is still wet or covered with snow, ice or mud. Even a heated garage can contribute to corrosion unless it is well ventilated so moisture is dispersed.

Keep paint and trim in good condition

Scratches or chips in the finish should be covered with "touch-up" paint as soon as possible to reduce the possibility of corrosion. If bare metal is showing through, the attention of a qualified body and paint shop is recommended.

Bird droppings : Bird droppings are highly corrosive and may damage painted surfaces in just a few hours. Always remove bird droppings as soon as possible.

Don't neglect the interior

Moisture can collect under the floor mats and carpeting to cause corrosion. Check under the mats periodically to be sure the carpeting is dry. Use particular care if you carry fertilizers, cleaning materials or chemicals in the car.

These should be carried only in proper containers and any spills or leaks should be cleaned up, flushed with clean water and thoroughly dried.

Interior care

Interior general precautions

Prevent chemicals such as perfume, cosmetic oil, sun cream, hand cleaner and air freshener from contacting the interior parts because they may cause damage or discoloration. If they do contact the interior parts, wipe them off immediately.

See the instructions that follow for the proper way to clean vinyl.

NOTICE

Never allow water or other liquids to come in contact with electrical/electronic components inside the vehicle as this may damage them.

NOTICE

When cleaning leather products (steering wheel, seats etc.), use neutral detergents or low alcohol content solutions. If you use high alcohol content solutions or acid/alkaline detergents, the color of the leather may fade or the surface may get stripped off.

Cleaning the upholstery and interior trim

Vinyl

Remove dust and loose dirt from vinyl with a whisk broom or vacuum cleaner. Clean vinyl surfaces with a vinyl cleaner.

Fabric

Remove dust and loose dirt from fabric with a whisk broom or vacuum cleaner. Clean with a mild soap solution recommended for upholstery or carpets. Remove fresh spots immediately with a fabric spot cleaner. If fresh spots do not receive immediate attention, the fabric can be stained and its color can be affected. Also, its fire-resistant properties can be reduced if the material is not properly maintained.

NOTICE

Using anything but recommended cleaners and procedures may affect the fabric's appearance and fire-resistant properties.

Cleaning the lap/shoulder belt webbing

Clean the belt webbing with any mild soap solution recommended for cleaning upholstery or carpet. Follow the instructions provided with the soap. Do not bleach or re-dye the webbing because this may weaken it.

Cleaning the interior window glass

If the interior glass surfaces of the vehicle become fogged (that is, covered with an oily, greasy or waxy film), they should be cleaned with glass cleaner. Follow the directions on the glass cleaner container.



CAUTION

Do not scrape or scratch the inside of the rear window. This may result in damage to the rear window defroster grid.

EMISSION CONTROL SYSTEM

The emission control system of your vehicle is covered by a written limited warranty. Please see the warranty information contained in the Service Passport in your vehicle.

Your vehicle is equipped with an emission control system to meet all emission regulations.

There are three emission control systems which are as follows.

- (1) Crankcase emission control system
- (2) Evaporative emission control system
- (3) Exhaust emission control system

In order to assure the proper function of the emission control systems, it is recommended that you have your car inspected and maintained by an authorized HYUNDAI dealer in accordance with the maintenance schedule in this manual.

CAUTION

For the Inspection and Maintenance Test (With Electronic Stability Control (ESC) system)

- **To prevent the vehicle from misfiring during dynamometer testing, turn the Electronic Stability Control (ESC) system off by pressing the ESC switch.**
- **After dynamometer testing is completed, turn the ESC system back on by pressing the ESC switch again.**

1. Crankcase emission control system

The positive crankcase ventilation system is employed to prevent air pollution caused by blow-by gases being emitted from the crankcase. This system supplies fresh filtered air to the crankcase through the air intake hose. Inside the crankcase, the fresh air mixes with blow-by gases, which then pass through the PCV valve into the induction system.

2. Evaporative emission control system

The Evaporative Emission Control System is designed to prevent fuel vapors from escaping into the atmosphere.

Canister

Fuel vapors generated inside the fuel tank are absorbed and stored in the onboard canister. When the engine is running, the fuel vapors absorbed in the canister are drawn into the surge tank through the purge control solenoid valve.

Purge Control Solenoid Valve (PCSV)

The purge control solenoid valve is controlled by the Engine Control Module (ECM); when the engine coolant temperature is low during idling, the PCSV closes so that evaporated fuel is not taken into the engine. After the engine warms-up during ordinary driving, the PCSV opens to introduce evaporated fuel to the engine.

3. Exhaust emission control system

The Exhaust Emission Control System is a highly effective system which controls exhaust emissions while maintaining good vehicle performance.

Vehicle modifications

This vehicle should not be modified. Modification of your vehicle could affect its performance, safety or durability and may even violate governmental safety and emissions regulations.

In addition, damage or performance problems resulting from any modification may not be covered under warranty.

- If you use unauthorized electronic devices, it may cause the vehicle to operate abnormally, wire damage, battery discharge and fire. For your safety, do not use unauthorized electronic devices.

Engine exhaust gas precautions (carbon monoxide)

- Carbon monoxide can be present with other exhaust fumes. Therefore, if you smell exhaust fumes of any kind inside your vehicle, have it inspected and repaired immediately. If you ever suspect exhaust fumes are coming into your vehicle, drive it only with all the windows fully open. Have your vehicle checked and repaired immediately.

⚠ WARNING

Engine exhaust gases contain carbon monoxide (CO). Though colorless and odorless, it is dangerous and could be lethal if inhaled. Follow the instructions following to avoid CO poisoning.

- Do not operate the engine in confined or closed areas (such as garages) any more than what is necessary to move the vehicle in or out of the area.
- When the vehicle is stopped in an open area for more than a short time with the engine running, adjust the ventilation system (as needed) to draw outside air into the vehicle.
- Never sit in a parked or stopped vehicle for any extended time with the engine running.
- When the engine stalls or fails to start, excessive attempts to restart the engine may cause damage to the emission control system.

Operating precautions for catalytic converters (if equipped)

⚠ WARNING

- **A hot exhaust system can ignite flammable items under your vehicle. Do not park, idle, or drive the vehicle over or near flammable objects, such as dry grass, paper, leaves, etc.**
- **The exhaust system and catalytic system are very hot while the engine is running or immediately after the engine is turned off. Keep away from the exhaust system and catalytic, you may get burned.**

Also, do not remove the heat sink around the exhaust system, do not seal the bottom of the vehicle or do not coat the vehicle for corrosion control. It may present a fire risk under certain conditions.

Your vehicle is equipped with a catalytic converter emission control device.

Therefore, the following precautions must be observed:



CAUTION

- Use only **UNLEADED FUEL** for gasoline engine.
- Do not operate the vehicle when there are signs of engine malfunction, such as misfire or a noticeable loss of performance.
- Do not misuse or abuse the engine. Examples of misuse are coasting with the engine off and descending steep grades in gear with the engine off.

(Continued)

(Continued)

- Do not operate the engine at high idle speed for extended periods (5 minutes or more).
- Do not modify or tamper with any part of the engine or emission control system. All inspections and adjustments must be made by an authorized HYUNDAI dealer.
- Avoid driving with a very low fuel level. If you run out of gasoline, it could cause the engine to misfire and result in excessive loading of the catalytic converter.

Failure to observe these precautions could result in damage to the catalytic converter and to your vehicle. Additionally, such actions could void your warranties.

Diesel particulate filter (DPF) (if equipped)

The Diesel Particulate Filter (DPF) system removes the soot in the exhaust gas.

The DPF system automatically burns (or oxidizes) the accumulated soot in accordance with the driving situations, unlike a disposable air filter.

In other words, the accumulated soot is automatically purged out by the engine control system and by the high exhaust-gas temperature at normal/high driving speeds.

However, when the vehicle is continually driven at repeated short distance or driven at low speed for a long time, the accumulated soot may not be automatically removed because of low exhaust gas temperature. In this case, the accumulated soot is out of the detection range, the soot oxidization process does not occur, and the Malfunction Indicator Lamp () illuminates.

The Malfunction Indicator Lamp (MIL) stops illuminating, when the driving speed exceeds 60 km/h (37mph), or when the engine rpm is between 1,500 and 2,500 with the gear in the 2nd position or above for approximately 25 minutes.

When the MIL continuously blinks or the warning message “Check exhaust system” illuminates in the above cases, we recommend you to have the DPF system checked by an authorized HYUNDAI dealer.

When the vehicle is continuously driven with the MIL flashing for an extended period of time, it may damage the DPF system and lower the fuel economy.

 **CAUTION**

**Diesel Fuel
(if equipped with DPF)**

We recommend you to use only the regulated diesel fuels, when your vehicle is equipped with the DPF system.

When you use other diesel fuels, which is high in sulfurs (above 50 ppm) or contains unspecified additives, it may damage the DPF system and cause the white smoke emission.

Lean NOx Trap (if equipped)

The Lean NOx Trap (LNT) system removes the nitrogen oxide in the exhaust gas. The smell can occur in the exhaust gas depending on the quality of the fuel and it can degrade NOx reduction performance, please use the regulated automotive diesel fuel.

Specifications & Consumer information

Dimensions	8-2
Engine	8-2
Bulb wattage	8-3
Tires and wheels	8-4
Air conditioning system	8-4
Tire load and speed capacity	8-5
Volume and weight	8-5
Recommended lubricants and capacities	8-6
Recommended SAE viscosity number	8-8
Vehicle identification number (VIN)	8-9
Vehicle certification label	8-9
Tire specification and pressure label	8-10
Engine number	8-10
Air conditioner compressor label	8-11
Declaration of conformity	8-11

DIMENSIONS

Items		mm (in)
Overall length		4,570 (179.9)
Overall width		1,800 (70.9)
Overall height		1,450 (57.1)
Front tread	195/65 R15	1,563 (61.5)
	205/55 R16	1,555 (61.2)
	225/45 R17	1,549 (61.0)
Rear tread	195/65 R15	1,572 (61.9)
	205/55 R16	1,564 (61.6)
	225/45 R17	1,558 (61.3)
Wheelbase		2,700 (106.3)

ENGINE

Item		Nu 2.0 MPI	Gamma 1.6 MPI	U2 1.6 TCI
Displacement	cc (cu. in)	1,999 (121.98)	1,591 (97.09)	1,582 (96.53)
Bore x Stroke	mm (in.)	81x97 (3.18x3.82)	77x85.4 (3.03x3.36)	77.2x84.5 (3.03x3.32)
Firing order		1-3-4-2	1-3-4-2	1-3-4-2
No. of cylinders		4, in-line	4, in-line	4, In-line

BULB WATTAGE

Light Bulb				Bulb type	Wattage	
Front	Headlamp	Low	Type A, B	9005L+	60	
			Type C	D5S	25	
		High		H7LL	55	
	Turn signal lamp			PY21W	21	
	Position lamp		Type A	W5W	5	
			Type B, C	LED	LED	
	Fog lamp*			HB4	51	
	Daytime running lamp (DRL)*		Type A, B	P21W	21	
		Type C	LED	LED		
Side Repeater lamp (Outside mirror)			LED	LED		
Rear	Rear combination lamp	Outside	Tail/Stop	Type A	P21/5W	21/5
				Type B, C	LED	LED
			Turn signal		PY21W	21
		Inside	Tail	Type A	P21/5W	5
				Type B, C	LED	LED
			Stop		LED	LED
	Back up		W16W	16		
	Fog		H21W	21		
	High mounted stop lamp		Bulb type	P21W	21	
	License plate lamp			W5W	5	
Interior	Map lamp			W10W	10	
	Room lamp			FESTOON	8	
	Sunvisor lamp			FESTOON	5	
	Luggage lamp			FESTOON	5	

* : if equipped

TIRES AND WHEELS

Item	Tire size	Wheel size	Inflation pressure, bar (kPa, psi)				Wheel lug nut torque kgf·m (lbf·ft, N·m)
			Normal load *1		Maximum load		
			Front	Rear	Front	Rear	
Full size tire	195/65 R15	6.0J X 15	2.3 (230, 33)	2.3 (230, 33)	2.3 (230, 33)	2.3 (230, 33)	11~13 (79~94, 107~127)
	205/55 R16	6.5J X 16					
	225/45 R17	7.0J X 17					
Compact spare tire (if equipped)	T125/80 D15	4.0T X 15	4.2 (420, 60)	4.2 (420, 60)	4.2 (420, 60)	4.2 (420, 60)	
	T125/80 D16	4.0T X 16					

*1: Normal load : Up to 3 persons

CAUTION

**When replacing tires, use the same size originally supplied with the vehicle.
Using tires of a different size can damage the related parts or not work properly.**

AIR CONDITIONING SYSTEM

Items	Weight of Volume	Classification
Refrigerant	500±25 (17.6±0.88) g (oz.)	R-1234yf (For Europe) R-134a (Except Europe)
Compressor lubricant	110±10 (3.88±0.35) g (oz.)	PAG (FD46XG)

Contact an authorized HYUNDAI dealer for more details.

TIRE LOAD AND SPEED CAPACITY

Item	Tire size	Wheel size	Load Capacity		Speed Capacity	
			LI *1	kg	SS *2	km/h
Full size tire	195/65 R15	6.0J X 15	91	615	H	210
	205/55 R16	6.5J X 16	91	615	H	210
	225/45 R17	7.0J X 17	91	615	W	270
Compact spare tire (if equipped)	T125/80 D15	4.0T X 15	95	690	M	130
	T125/80 D16	4.0T X 16	97	730	M	130

*1 LI : LOAD INDEX

*2 SS : SPEED SYMBOL

VOLUME AND WEIGHT

Items		Nu 2.0 MPI		Gamma 1.6 MPI		U2 1.6 TCI	
		M/T	A/T	M/T	A/T	M/T	DCT
Gross vehicle weight	kg (lbs.)	1,800 (3,968)	1,820 (4,012)	1,770 (3,902)	1,800 (3,968)	1,870 (4,122)	1,900 (4,188)
Luggage volume (VDA)	l (cu ft)	458 (16.2)					

M/T : Manual Transmission

A/T : Automatic Transmission

DCT : Dual Clutch Transmission

RECOMMENDED LUBRICANTS AND CAPACITIES

To help achieve proper engine and powertrain performance and durability, use only lubricants of the proper quality. The correct lubricants also help promote engine efficiency that results in improved fuel economy.

These lubricants and fluids are recommended for use in your vehicle.

Lubricant		Volume	Classification	
Engine oil *1 *2 (drain and refill) Recommends 	Nu 2.0 MPI	4.0 l (4.23 US qt.)	Except Middle East, Morocco, Sudan, Egypt	API SM*4 & ILSAC GF-4 (or above)
				ACEA A5*3 (or above)
	Gamma 1.6 MPI	3.6 l (3.80 US qt.)	For Middle East, Morocco, Sudan, Egypt	ACEA A5*3 (or above)
			Except Middle East, Morocco, Sudan, Egypt	API SM*4 & ILSAC GF-4 (or above)
	U2 1.6 TCI	5.3 l (5.6 US qt.)		ACEA A5*3 (or above)
			with DPF	ACEA C2 or C3*5
		without DPF	ACEA B4*5	
Manual transmission fluid	Nu 2.0 MPI/ U2 1.6 TCI	1.7~1.8 l (1.8~1.9 US qt.)	HK MTF 70W (SK) SPIRAX S6 GHME 70W MTF (H.K.SHELL) GS MTF HD 70W (GS CALTEX) (API GL-4, SAE 70W)	
	Gamma 1.6 MPI	1.6~1.7 l (1.7~1.8 US qt.)		
Automatic transmission fluid	Nu 2.0 MPI	6.7 l (7.08 US qt.)	MICHANG ATF SP-IV, SK ATF SP-IV, NOCA ATF SP-IV, HYUNDAI genuine ATF SP-IV	
	Gamma 1.6 MPI	6.7 l (7.08 US qt.)		

Lubricant			Volume	Classification
Dual clutch transmission fluid			1.9~2.0 l (2.01~2.11 US qt.)	HK MTF 70W (SK) SPIRAX S6 GHME 70W DCTF (H.K.SHELL) GS MTF HD 70W (GS CALTEX) (API GL-4, SAE 70W)
Coolant	Nu 2.0 MPI	M/T	5.9 l (6.23 US qt)	Mixture of antifreeze and water (Phosphate-based Ethylene glycol coolant for aluminum radiator)
		A/T	5.8 l (6.13 US qt)	
	Gamma 1.6 MPI	M/T	5.7 l (6.02 US qt)	
		A/T	5.6 l (5.92 US qt)	
U2 1.6 TCI		6.7 l (7.08 US qt)		
Brake/Clutch fluid			0.7~0.8 l (0.74~0.85 US qt.)	FMVSS116 DOT-3 or DOT-4
Fuel			50 l (52.83 US qt.)	Refer to “Fuel requirements” in the Foreword chapter.

*1 : Refer to the recommended SAE viscosity numbers on the next page.

*2 : Engine oils labeled Energy Conserving Oil are now available. Along with other additional benefits, they contribute to fuel economy by reducing the amount of fuel necessary to overcome engine friction. Often, these improvements are difficult to measure in everyday driving, but in a year's time, they can offer significant cost and energy savings.

*3 : If the ACEA A5 engine oil is not available in your country, you are able to use ILSAC GF-3 (or above) or ACEA A3 (or above).

*4 : If the API service SM engine oil is not available in your country, you are able to use API service SL.

*5 : If the ACEA C2 or C3, B4 engine oil is not available in your country, you are able to use API CH-4 (or above).

Recommended SAE viscosity number

CAUTION

Always be sure to clean the area around any filler plug, drain plug, or dipstick before checking or draining any lubricant. This is especially important in dusty or sandy areas and when the vehicle is used on unpaved roads. Cleaning the plug and dipstick areas will prevent dirt and grit from entering the engine and other mechanisms that could be damaged.

Engine oil viscosity (thickness) has an effect on fuel economy and cold weather operating (engine start and engine oil flowability). Lower viscosity engine oils can provide better fuel economy and cold weather performance, however, higher viscosity engine oils are required for satisfactory lubrication in hot weather. Using oils of any viscosity other than those recommended could result in engine damage.

When choosing an oil, consider the range of temperature your vehicle will be operated in before the next oil change. Proceed to select the recommended oil viscosity from the chart.

		Temperature Range for SAE Viscosity Numbers									
Temperature	°C	-30	-20	-10	0	10	20	30	40	50	
		(°F)	-10	0	20	40	60	80	100	120	
Gasoline Engine Oil	For Europe	0W-40, 5W-20, 5W-30, 5W-40									
	Except Europe & Middle East* ³					20W-50					
					15W-40						
				10W-30							
			5W-20* ¹ , 5W-30								
	For Middle East* ³					20W-50					
			15W-40								
		10W-30									
		5W-30* ² , 5W-40									
Diesel Engine Oil					15W-40						
				10W-30							
			5W-30								
		0W-30									

*¹ : For better fuel economy, it is recommended to use the engine oil of a viscosity grade SAE 5W-20

*² : For better fuel economy, it is recommended to use the engine oil of a viscosity grade SAE 5W-30. However, if the engine oil is not available in your country, select the proper engine oil using the engine oil viscosity chart.

*³ : Middle East includes Morocco, Sudan and Egypt.

VEHICLE IDENTIFICATION NUMBER (VIN)

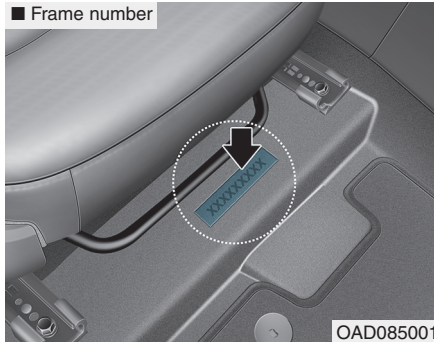

The vehicle identification number (VIN) is the number used in registering your vehicle and in all legal matters pertaining to its ownership, etc. The number is punched on the floor under the passenger seat. To check the number, open the cover.

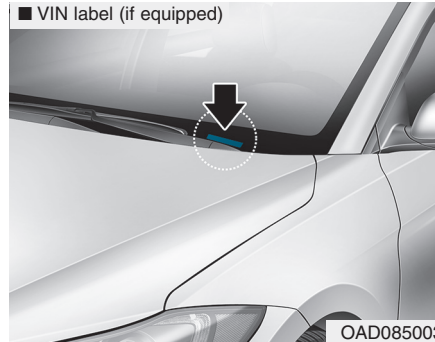

The VIN is also on a plate attached to the top of the dashboard. The number on the plate can easily be seen through the windshield from outside.

VEHICLE CERTIFICATION LABEL

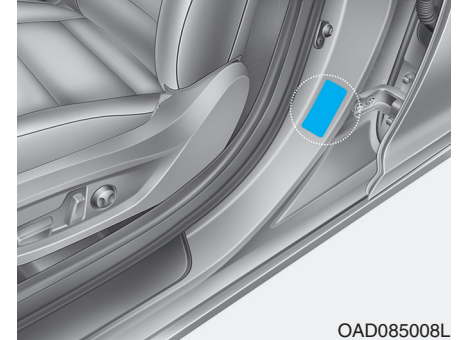

The vehicle certification label attached on the driver's (or front passenger's) side center pillar gives the vehicle identification number (VIN).

TIRE SPECIFICATION AND PRESSURE LABEL

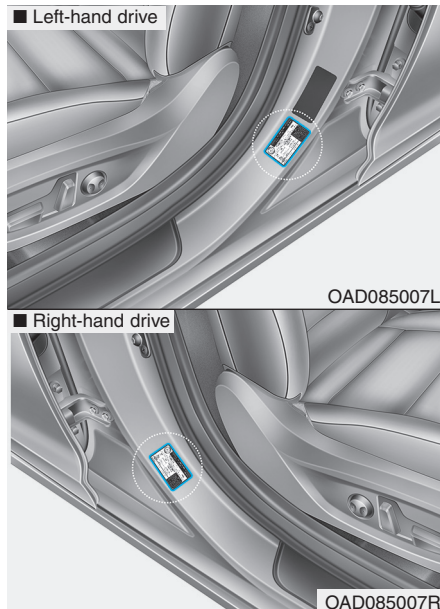

The tires supplied on your new vehicle are chosen to provide the best performance for normal driving.

The tire label located on the driver's side center pillar gives the tire pressures recommended for your vehicle.

ENGINE NUMBER

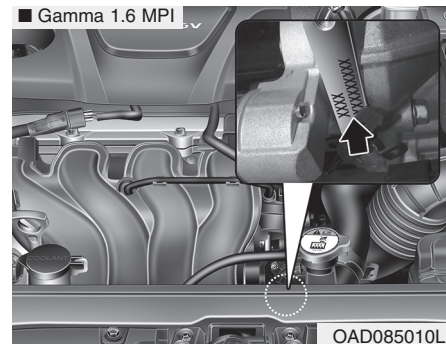
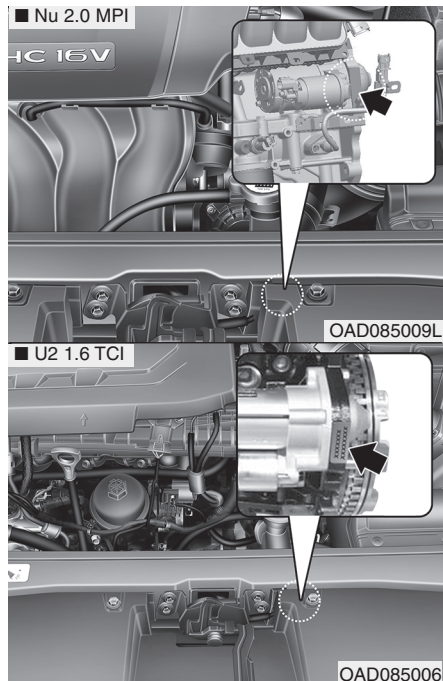

The engine number is stamped on the engine block as shown in the drawing.

AIR CONDITIONER COMPRESSOR LABEL



A compressor label informs you the type of compressor your vehicle is equipped with such as model, supplier part number, production number, refrigerant (1) and refrigerant oil (2).

DECLARATION OF CONFORMITY

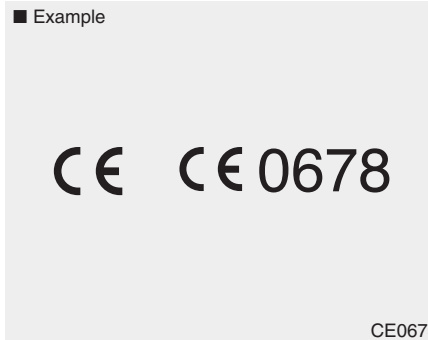

The radio frequency components of the vehicle comply with requirements and other relevant provisions of Directive 1995/5/EC.

Further information including the manufacturer's declaration of conformity is available on HYUNDAI web site as follows:

<http://service.hyundai-motor.com>