

To our customers,

Old Company Name in Catalogs and Other Documents

On April 1st, 2010, NEC Electronics Corporation merged with Renesas Technology Corporation, and Renesas Electronics Corporation took over all the business of both companies. Therefore, although the old company name remains in this document, it is a valid Renesas Electronics document. We appreciate your understanding.

Renesas Electronics website: <http://www.renesas.com>

April 1st, 2010
Renesas Electronics Corporation

Issued by: Renesas Electronics Corporation (<http://www.renesas.com>)

Send any inquiries to <http://www.renesas.com/inquiry>.

Notice

1. All information included in this document is current as of the date this document is issued. Such information, however, is subject to change without any prior notice. Before purchasing or using any Renesas Electronics products listed herein, please confirm the latest product information with a Renesas Electronics sales office. Also, please pay regular and careful attention to additional and different information to be disclosed by Renesas Electronics such as that disclosed through our website.
2. Renesas Electronics does not assume any liability for infringement of patents, copyrights, or other intellectual property rights of third parties by or arising from the use of Renesas Electronics products or technical information described in this document. No license, express, implied or otherwise, is granted hereby under any patents, copyrights or other intellectual property rights of Renesas Electronics or others.
3. You should not alter, modify, copy, or otherwise misappropriate any Renesas Electronics product, whether in whole or in part.
4. Descriptions of circuits, software and other related information in this document are provided only to illustrate the operation of semiconductor products and application examples. You are fully responsible for the incorporation of these circuits, software, and information in the design of your equipment. Renesas Electronics assumes no responsibility for any losses incurred by you or third parties arising from the use of these circuits, software, or information.
5. When exporting the products or technology described in this document, you should comply with the applicable export control laws and regulations and follow the procedures required by such laws and regulations. You should not use Renesas Electronics products or the technology described in this document for any purpose relating to military applications or use by the military, including but not limited to the development of weapons of mass destruction. Renesas Electronics products and technology may not be used for or incorporated into any products or systems whose manufacture, use, or sale is prohibited under any applicable domestic or foreign laws or regulations.
6. Renesas Electronics has used reasonable care in preparing the information included in this document, but Renesas Electronics does not warrant that such information is error free. Renesas Electronics assumes no liability whatsoever for any damages incurred by you resulting from errors in or omissions from the information included herein.
7. Renesas Electronics products are classified according to the following three quality grades: “Standard”, “High Quality”, and “Specific”. The recommended applications for each Renesas Electronics product depends on the product’s quality grade, as indicated below. You must check the quality grade of each Renesas Electronics product before using it in a particular application. You may not use any Renesas Electronics product for any application categorized as “Specific” without the prior written consent of Renesas Electronics. Further, you may not use any Renesas Electronics product for any application for which it is not intended without the prior written consent of Renesas Electronics. Renesas Electronics shall not be in any way liable for any damages or losses incurred by you or third parties arising from the use of any Renesas Electronics product for an application categorized as “Specific” or for which the product is not intended where you have failed to obtain the prior written consent of Renesas Electronics. The quality grade of each Renesas Electronics product is “Standard” unless otherwise expressly specified in a Renesas Electronics data sheets or data books, etc.
 - “Standard”: Computers; office equipment; communications equipment; test and measurement equipment; audio and visual equipment; home electronic appliances; machine tools; personal electronic equipment; and industrial robots.
 - “High Quality”: Transportation equipment (automobiles, trains, ships, etc.); traffic control systems; anti-disaster systems; anti-crime systems; safety equipment; and medical equipment not specifically designed for life support.
 - “Specific”: Aircraft; aerospace equipment; submersible repeaters; nuclear reactor control systems; medical equipment or systems for life support (e.g. artificial life support devices or systems), surgical implantations, or healthcare intervention (e.g. excision, etc.), and any other applications or purposes that pose a direct threat to human life.
8. You should use the Renesas Electronics products described in this document within the range specified by Renesas Electronics, especially with respect to the maximum rating, operating supply voltage range, movement power voltage range, heat radiation characteristics, installation and other product characteristics. Renesas Electronics shall have no liability for malfunctions or damages arising out of the use of Renesas Electronics products beyond such specified ranges.
9. Although Renesas Electronics endeavors to improve the quality and reliability of its products, semiconductor products have specific characteristics such as the occurrence of failure at a certain rate and malfunctions under certain use conditions. Further, Renesas Electronics products are not subject to radiation resistance design. Please be sure to implement safety measures to guard them against the possibility of physical injury, and injury or damage caused by fire in the event of the failure of a Renesas Electronics product, such as safety design for hardware and software including but not limited to redundancy, fire control and malfunction prevention, appropriate treatment for aging degradation or any other appropriate measures. Because the evaluation of microcomputer software alone is very difficult, please evaluate the safety of the final products or system manufactured by you.
10. Please contact a Renesas Electronics sales office for details as to environmental matters such as the environmental compatibility of each Renesas Electronics product. Please use Renesas Electronics products in compliance with all applicable laws and regulations that regulate the inclusion or use of controlled substances, including without limitation, the EU RoHS Directive. Renesas Electronics assumes no liability for damages or losses occurring as a result of your noncompliance with applicable laws and regulations.
11. This document may not be reproduced or duplicated, in any form, in whole or in part, without prior written consent of Renesas Electronics.
12. Please contact a Renesas Electronics sales office if you have any questions regarding the information contained in this document or Renesas Electronics products, or if you have any other inquiries.

(Note 1) “Renesas Electronics” as used in this document means Renesas Electronics Corporation and also includes its majority-owned subsidiaries.

(Note 2) “Renesas Electronics product(s)” means any product developed or manufactured by or for Renesas Electronics.

8-BIT SINGLE-CHIP MICROCONTROLLER

The μ 78F9210FH, 78F9211FH, and 78F9212FH are products of the 78K0S/KY1+ in the 78K/0S series.

These microcontrollers feature Single-voltage and Self-programming Flash memory and peripherals that is suitable for your application.

The functions of these microcontrollers are described in the following user's manuals. Refer to these manuals when designing a system based on any of these microcontrollers.

78K0S/KY1+ User's Manual : U16994E

78K/0S Series User's Manual, Instruction : U11047E

FEATURES

- 78K/0S CPU core, 8-bit CISC architecture
- ROM and RAM capacities

Item	Program memory (Flash EEPROM)	Data memory (High-speed RAM)
μ PD78F9210FH	1 Kbytes	128 bytes
μ PD78F9211FH	2 Kbytes	128 bytes
μ PD78F9212FH	4 Kbytes	128 bytes

- Minimum instruction execution time
Minimum instruction execution time selectable from high speed (0.2 μ s) to low speed (3.2 μ s) (with CPU clock of 10 MHz)
- System clock
High-speed internal oscillator: 8 MHz (TYP.)
Ceramic/crystal oscillator: 1 MHz to 10 MHz
- WDT clock
Low-speed internal oscillator: 240 kHz (TYP.)
- Interrupt
External: 2 sources Internal: 5 sources
- I/O port: 14
CMOS I/O: 13
CMOS Input: 1
- On-chip A/D Converter
10-bit resolution A/D converter: 4 ch (2.7 to 5.5 V)
- Timer/Counter
16-bit Timer: 1 ch
8-bit Timer: 1 ch
- Watchdog Timer: 1 ch
- Operation Voltage: 2.0 V to 5.5 V
- Package: 16-pin WLCSP (1.93 x 2.24 x thickness of 0.4 mm, 0.5 mm pitch)

APPLICATION FIELDS

Household electrical appliances, Toys, Mobile device

The information contained in this document is being issued in advance of the production cycle for the product. The parameters for the product may change before final production or NEC Electronics Corporation, at its own discretion, may withdraw the product prior to its production. Not all products and/or types are available in every country. Please check with an NEC Electronics sales representative for availability and additional information.

ORDERING INFORMATION

Part Number	Package
μ PD78F9210FH-2A2-A	16-pin WLCSP (1.93x2.24x0.4 mm in thickness, 0.5 mm pitch)
μ PD78F9211FH-2A2-A	16-pin WLCSP (1.93x2.24x0.4 mm in thickness, 0.5 mm pitch)
μ PD78F9212FH-2A2-A	16-pin WLCSP (1.93x2.24x0.4 mm in thickness, 0.5 mm pitch)

Remark Products with -A at the end of the part number are lead-free products.

OVERVIEW OF FUNCTIONS

Item		μPD78F9210FH	μPD78F9211FH	μPD78F9212FH
Internal memory	Flash memory	1 KB	2 KB	4 KB
	High-speed RAM ^{Note 1}	128 bytes		
Memory space		64 KB		
X1 input clock (oscillation frequency)		Crystal/ceramic oscillation, external system clock input 10 MHz: V _{DD} = 2.0 to 5.5 V		
Internal oscillation clock	High-speed	Internal oscillation: 8 MHz (TYP.)		
	Low-speed	Internal oscillation: 240 kHz (TYP.)		
General-purpose registers		8 bits × 8 registers		
Instruction execution time		0.2 μs/0.4 μs/0.8 μs/1.6 μs/3.2 μs/ (X1 input clock: @ f _x = 10 MHz operation)		
I/O ports		Total: 14 CMOS I/O: 13 CMOS Input: 1		
Timers		<ul style="list-style-type: none"> • 16-bit timer/event counter: 1 channel • 8-bit timer(Timer H1): 1 channel • Watchdog timer: 1 channel 		
	Timer outputs	2 (PWM output: 1)		
A/D converter		10-bit resolution × 4 channels		
Vectored interrupt sources	External	2		
	Internal	5		
Reset		<ul style="list-style-type: none"> • Reset using RESET pin • Internal reset by watchdog timer • Internal reset by power-on-clear • Internal reset by low-voltage detector 		
Power supply voltage		V _{DD} = 2.0 to 5.5 V ^{Note}		
Operating ambient temperature		T _A = -40 to +85°C		
Package		16-pin WLCSP		

Note Use this product in a voltage range of 2.2 to 5.5 V because the detection voltage (V_{POC}) of the power-on-clear(POC) circuit is 2.1 V ±0.1 V.

CONTENTS

1. PIN CONFIGURATION.....	5
2. BLOCK DIAGRAM.....	6
3. PIN FUNCTIONS.....	7
3.1 Port Pins.....	7
3.2 Non-Port Pins.....	8
3.3 Pin I/O Circuits and Recommended Connection of Unused Pins.....	9
4. MEMORY SPACE.....	11
4.1 Memory Space.....	11
4.2 Memory Configuration.....	14
5. OPTION BYTE.....	15
5.1 Functions of Option Byte.....	15
5.2 Format of Option Byte.....	16
6. SOURCE CLOCK OF EACH TIMER.....	18
7. ELECTRICAL SPECIFICATIONS (TARGET VALUES).....	19
8. PACKAGE DRAWING (PRELIMINARY).....	31
APPENDIX A RELATED DOCUMENTS.....	32

1. PIN CONFIGURATION

- 16-pin WLCSP (1.93x2.24x0.4 mm in thickness, 0.5 mm pitch)

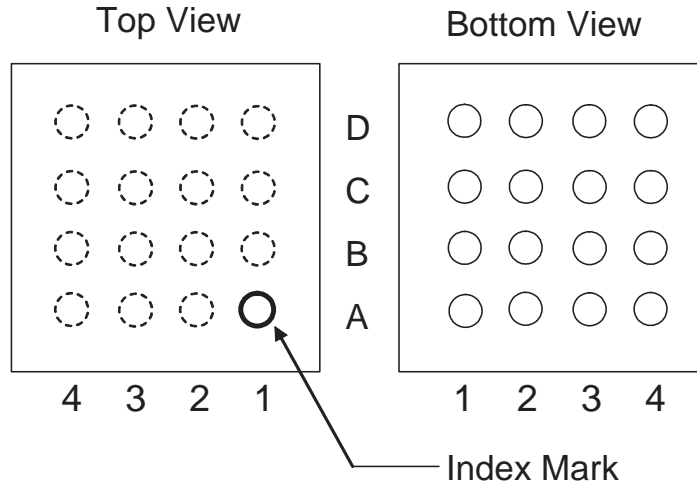

Pin No.	Pin Name	Pin No.	Pin Name
A1	P20/ANI0/TI000/TOH1	C1	P42
A2	V _{SS} ^{Note1}	C2	P43
A3	P47	C3	P34/ <u>RESET</u>
A4	P23/X1/ANI3	C4	P45
B1	P41	D1	P21/ANI1/TI010/TO000/INTP0
B2	P40	D2	P32/INTP1
B3	V _{DD} ^{Note2}	D3	P44
B4	P46	D4	P22/X2/ANI2

- | | | | |
|----------------|--------------------------|------------------------------------|-------------------------------------|
| ANI0 to ANI3: | Analog input | TI000, TI010: | Timer input |
| INTP0, INTP1: | External interrupt input | TO00, TOH1: | Timer output |
| P20 to P23: | Port 2 | V _{DD} ^{Note2} : | Power supply |
| P32, P34: | Port 3 | V _{SS} ^{Note1} : | Ground |
| P40 to P47: | Port 4 | X1, X2: | Crystal oscillator (X1 input clock) |
| <u>RESET</u> : | Reset | | |

- Notes 1.** V_{SS} functions alternately as the ground potential of the A/D converter. Be sure to connect V_{SS} to a stabilized GND (= 0 V).
- 2.** V_{DD} functions alternately as the A/D converter reference voltage input. When using the A/D converter, stabilize V_{DD} at the supply voltage used (2.7 to 5.5 V).

2. BLOCK DIAGRAM

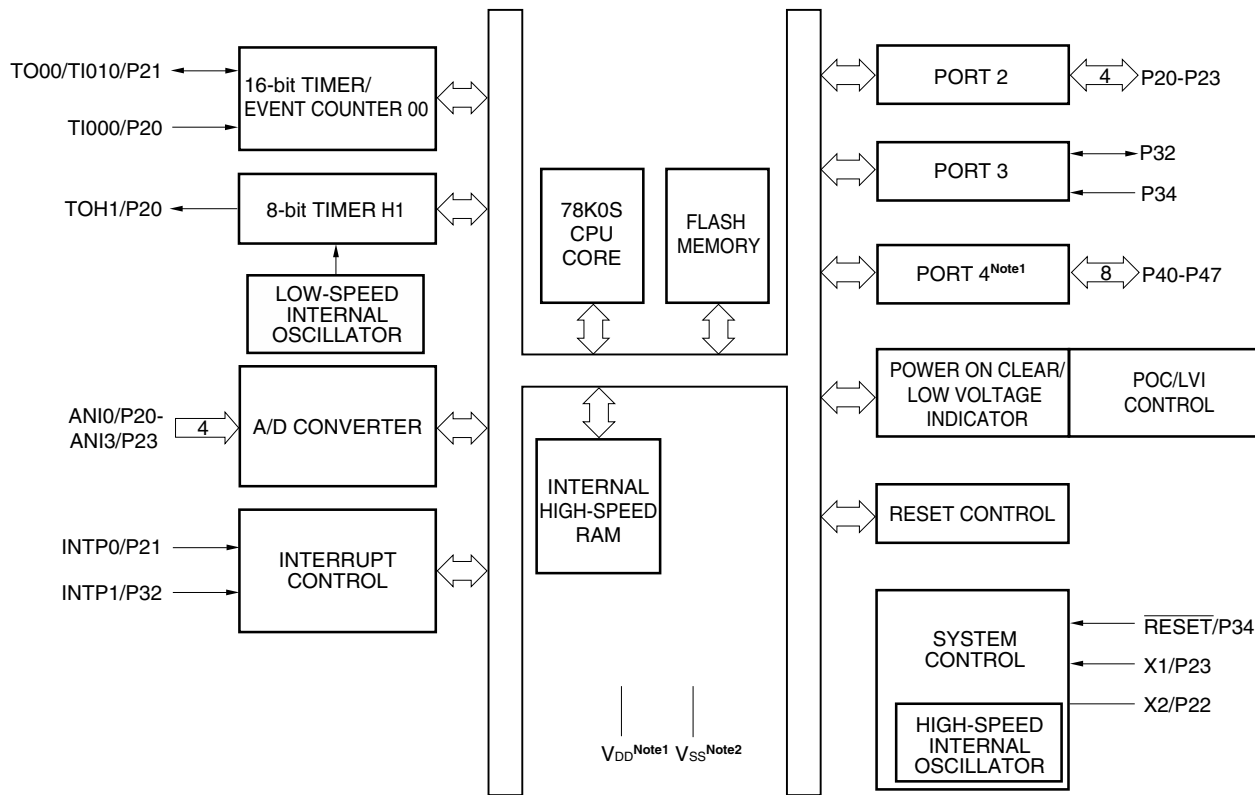

- Notes**
1. V_{DD} functions alternately as the A/D converter reference voltage input. When using the A/D converter, stabilize V_{DD} at the supply voltage used (2.7 to 5.5 V).
 2. V_{SS} functions alternately as the ground potential of the A/D converter. Be sure to connect V_{SS} to a stabilized GND (= 0 V).

3. PIN FUNCTIONS

3.1 Port Pins

Pin Name	I/O	Function		After Reset	Alternate-Function Pin
P20	I/O	Port 2. 4-bit I/O port. Can be set to input or output mode in 1-bit units. An on-chip pull-up resistor can be connected by setting software.		Input	ANI0/TI000/TOH1
P21					ANI1/TI010/ TO00/INTP0
P22 ^{Note}					X2/ANI2 ^{Note}
P23 ^{Note}					X1/ANI3 ^{Note}
P32	I/O	Port 3	Can be set to input or output mode in 1-bit units. An on-chip pull-up resistor can be connected by setting software.	Input	INTP1
P34 ^{Note}	Input		Input only	Input	RESET ^{Note}
P40 to P47	I/O	Port 4. 8-bit I/O port. Can be set to input or output mode in 1-bit units. An on-chip pull-up resistor can be connected by setting software.		Input	—

Note For the setting method for pin functions, see 5. OPTION BYTE.

Caution The P22/X2/ANI2 and P23/X1/ANI3 pins are pulled down during reset.

3.2 Non-Port Pins

Pin Name	I/O	Function	After Reset	Alternate-Function Pin
INTP0	Input	External interrupt input for which the valid edge (rising edge, falling edge, or both rising and falling edges) can be specified	Input	P21/ANI1/TI010/ TO00
INTP1				P32
TI000	Input	External count clock input to 16-bit timer/event counter 00. Capture trigger input to capture registers (CR000 and CR010) of 16-bit timer/event counter 00	Input	P20/ANI0/TOH1
TI010		Capture trigger input to capture register (CR000) of 16-bit timer/event counter 00		P21/ANI1/TO00/ INTP0
TO00	Output	16-bit timer/event counter 00 output	Input	P21/ANI1/TI010/ INTP0
TOH1	Output	8-bit timer H1 output	Input	P20/ANI0/TI000
ANI0	Input	Analog input of A/D converter	Input	P20/TI000/TOH1
ANI1				P21/TI010/TO00/ INTP0
ANI2 ^{Note}				P22/X2 ^{Note}
ANI3 ^{Note}				P23/X1 ^{Note}
RESET ^{Note}	Input	System reset input	Input	P34 ^{Note}
X1 ^{Note}	Input	Connection of crystal/ceramic oscillator for system clock oscillation. External clock input.	–	P23/ANI3 ^{Note}
X2 ^{Note}	–	Connection of crystal/ceramic oscillator for system clock oscillation.	–	P22/ANI2 ^{Note}
V _{DD}	–	Positive power supply	–	–
V _{SS}	–	Ground potential	–	–

Note For the setting method for pin functions, see 5. OPTION BYTE.

Caution The P22/X2/ANI2 and P23/X1/ANI3 pins are pulled down during reset.

3.3 Pin I/O Circuits and Recommended Connection of Unused Pins

The input/output circuit type of each pin and recommended connection of unused pins is shown in Table 3-1. For the input/output circuit configuration of each type, refer to Figure 3-1.

Table 3-1. Type of I/O Circuit for Each Pin and Connection of Unused Pins

Pin Name	I/O Circuit Type	I/O	Recommended Connection of Unused Pin
P20/ANI0/TI000/TOH1	11	I/O	Input: Individually connect to V _{DD} or V _{SS} via resistor. Output: Leave open.
P21/ANI1/TI010/TO00/ INTP0			
P22/ANI2/X2	36		Input: Individually connect to V _{SS} via resistor. Output: Leave open.
P23/ANI3/X1			
P32/INTP1	8-A	Input: Individually connect to V _{DD} or V _{SS} via resistor. Output: Leave open.	
P34/ <u>RESET</u>	2	Input	Connect to V _{DD} via resistor.
P40 to P47	8-A	I/O	Input: Individually connect to V _{DD} or V _{SS} via resistor. Output: Leave open.

Figure 3-1. Pin Input/Output Circuits

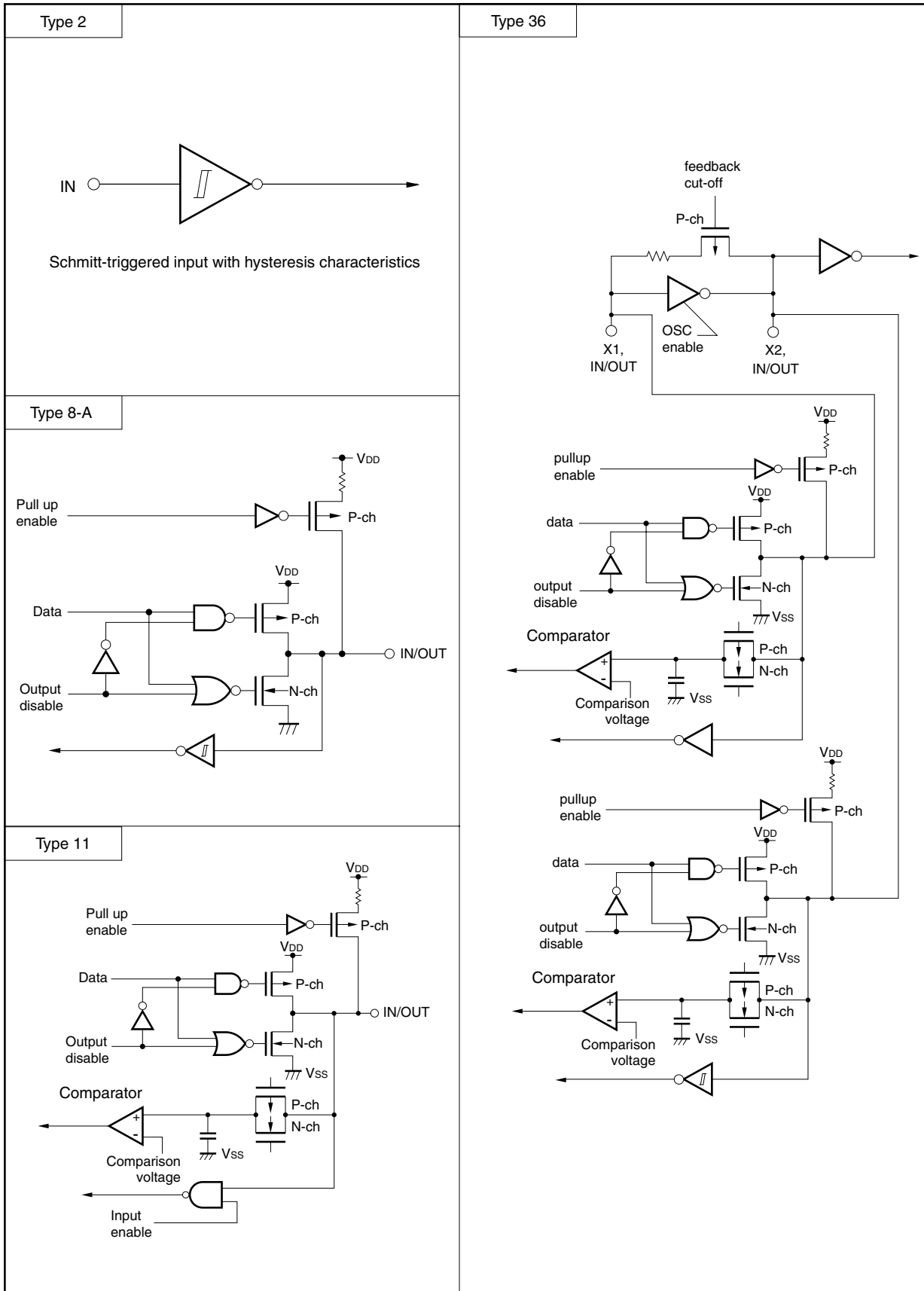

4. MEMORY SPACE

4.1 Memory Space

Products in the μPD78F9210FH, 78F9211FH, and 78F9212FH can access up to 64 Kbytes of memory space. Figures 4-1 to 4-3 show the memory maps.

Figure 4-1. Memory Map (μPD78F9210FH)

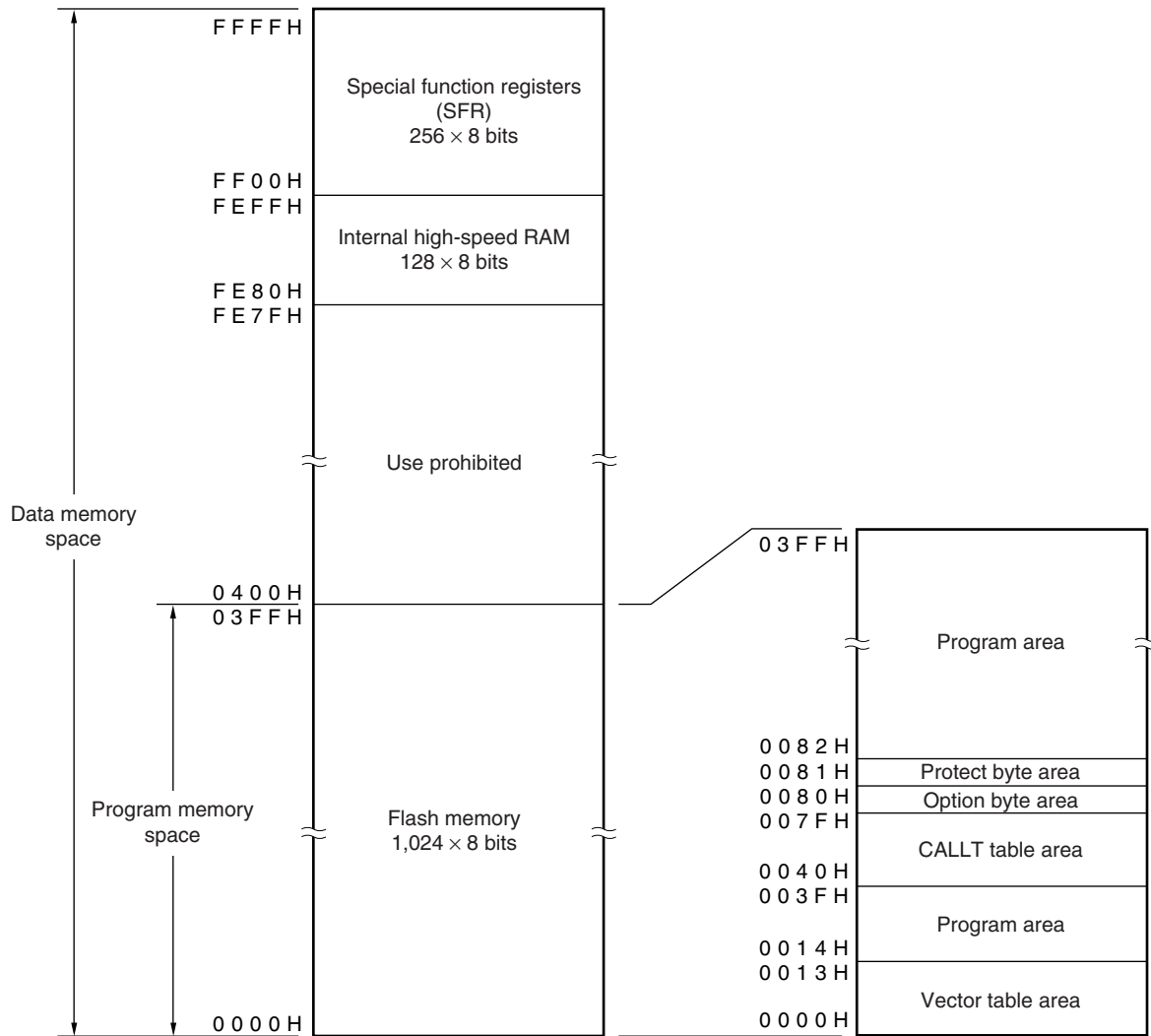

Remark The option byte and protect byte are 1 byte each.

Figure 4-2. Memory Map (μPD78F9211FH)

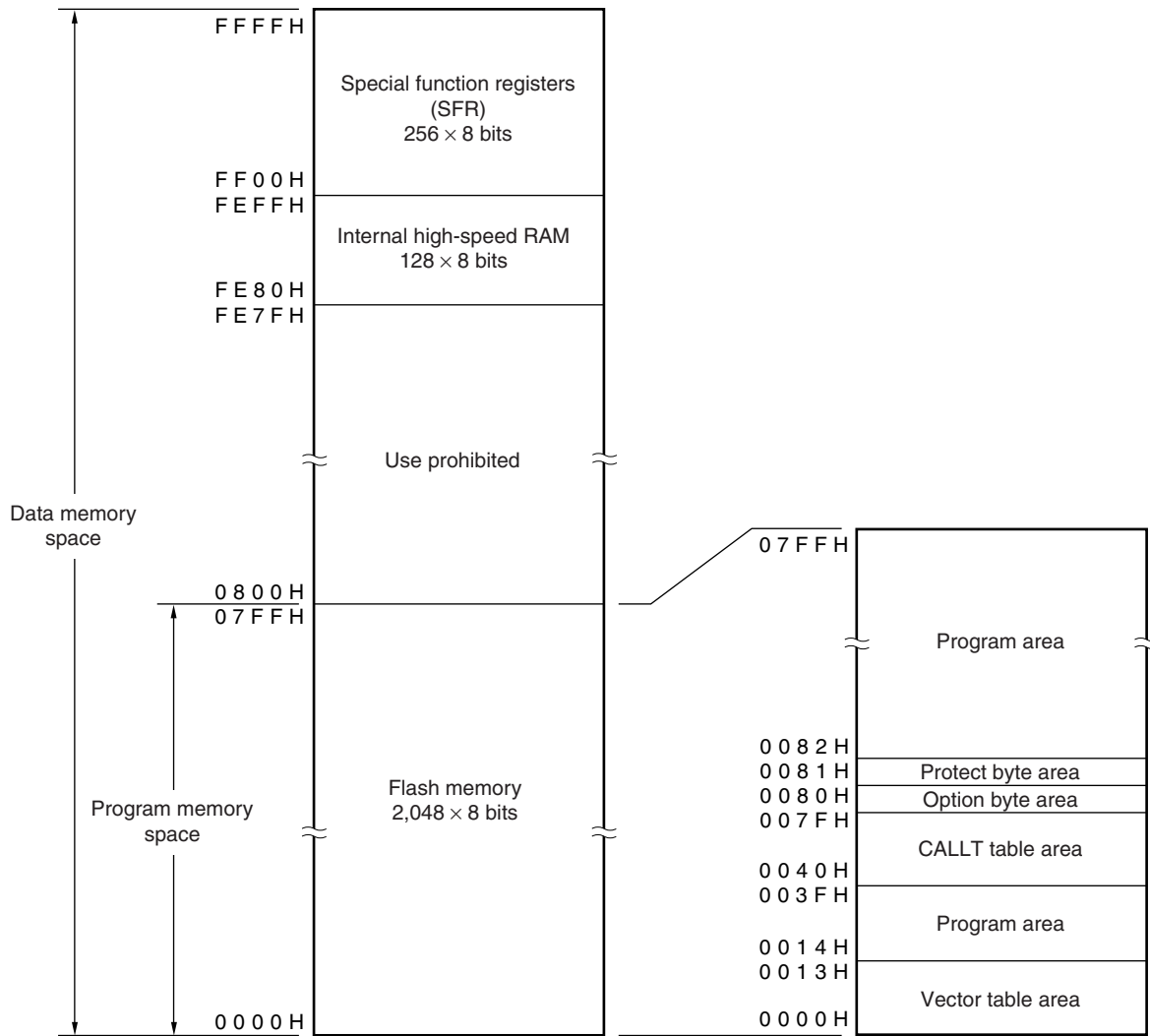

Remark The option byte and protect byte are 1 byte each.

Figure 4-3. Memory Map (μPD78F9212FH)

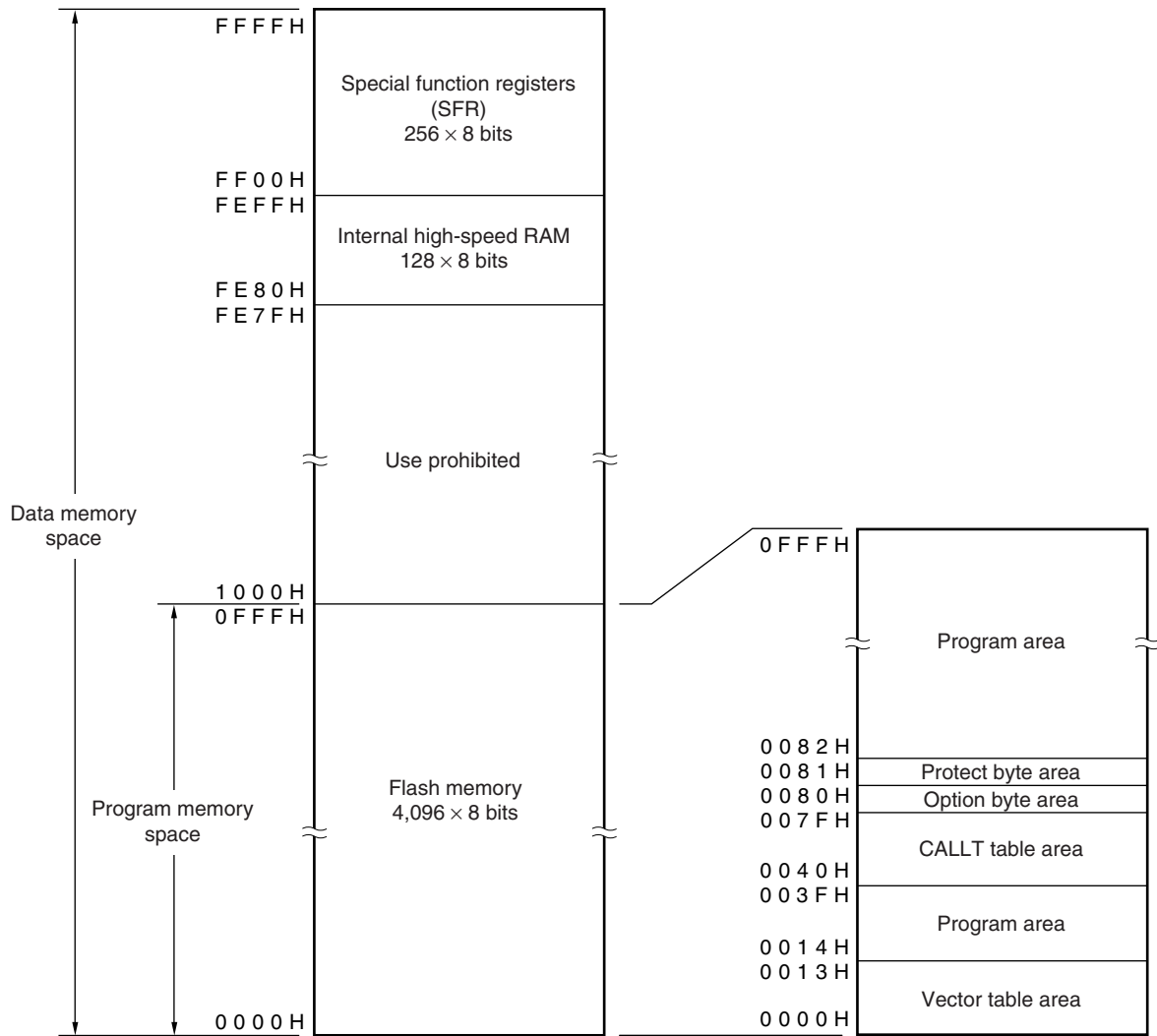

Remark The option byte and protect byte are 1 byte each.

4.2 Memory Configuration

The 1/2/4 KB internal flash memory area is divided into 4/8/16 blocks and can be programmed/erased in block units. All the blocks can also be erased at once, by using a dedicated flash programmer.

Figure 4-4. Flash Memory Mapping

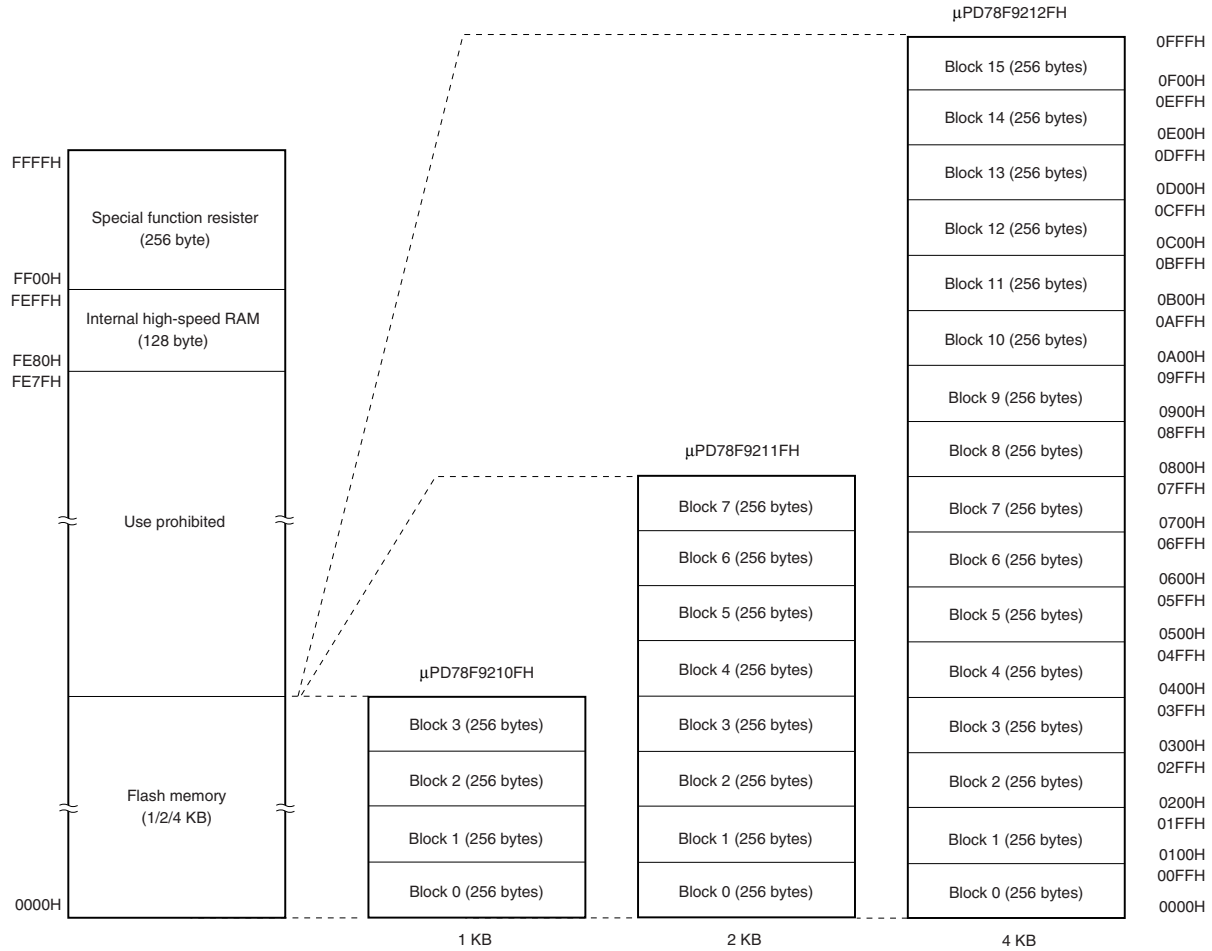

5. OPTION BYTE

5.1 Functions of Option Byte

The address 0080H of the flash memory of the μPD78F9210FH, 78F9211FH, and 78F9212FH is an option byte area. When power is supplied or when starting after a reset, the option byte is automatically referenced, and settings for the specified functions are performed. When using the product, be sure to set the following functions by using the option byte.

- (1) Selection of system clock source
 - High-speed internal oscillation clock
 - Crystal/ceramic oscillation clock
 - External clock input
- (2) Low-speed internal oscillation clock oscillation
 - Cannot be stopped.
 - Can be stopped by software.
- (3) Control of RESET pin
 - Used as RESET pin
 - RESET pin is used as an input port pin (P34).
- (4) Oscillation stabilization time on power application or after reset release
 - $2^{10}/f_x$
 - $2^{12}/f_x$
 - $2^{15}/f_x$
 - $2^{17}/f_x$

Figure 5-1. Positioning of Option Byte

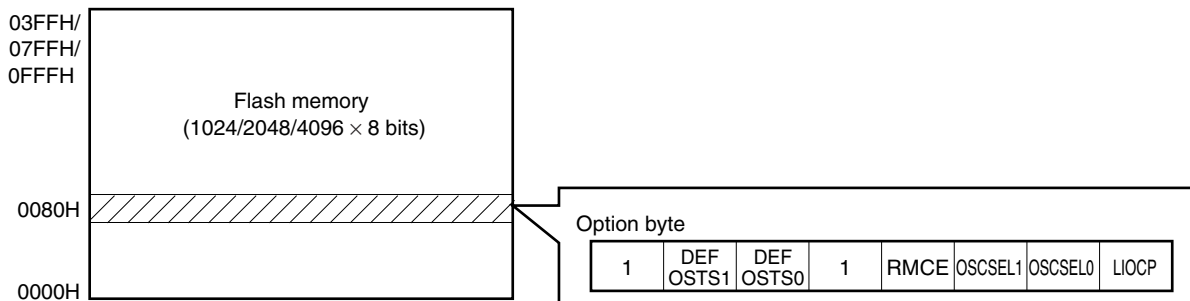

5.2 Format of Option Byte

Format of option bytes is shown below.

Figure 5-2. Format of Option Byte (1/2)

Address: 0080H

7	6	5	4	3	2	1	0
1	DEFOSTS1	DEFOSTS0	1	RMCE	OSCSEL1	OSCSEL0	LIOCP

DEFOSTS1	DEFOSTS0	Oscillation stabilization time on power application or after reset release
0	0	$2^{10}/f_x$ (102.4 μs)
0	1	$2^{12}/f_x$ (409.6 μs)
1	0	$2^{15}/f_x$ (3.27 ms)
1	1	$2^{17}/f_x$ (13.1 ms)

Caution The setting of this option is valid only when the crystal/ceramic oscillation clock is selected as the system clock source. No wait time elapses if the high-speed internal oscillation clock or external clock input is selected as the system clock source.

RMCE	Control of RESET pin
1	Used as RESET pin.
0	RESET pin is used as input port pin (P34).

Caution Because the option byte is referenced after reset release, if a low level is input to the RESET pin before the option byte is referenced, then the reset state is not released. Also, when setting 0 to RMCE, connect the pull-up resistor.

OSCSEL1	OSCSEL0	Selection of system clock source
0	0	Crystal/ceramic oscillation clock
0	1	External clock input
1	×	High-speed internal oscillation clock

Caution Because the X1 and X2 pins are also used as the P23/ANI3 and P22/ANI2 pins, the conditions under which the X1 and X2 pins can be used differ depending on the selected system clock source.

(1) Crystal/ceramic oscillation clock is selected

The X1 and X2 pins cannot be used as I/O port pins or analog input pins of A/D converter because they are used as clock input pins.

(2) External clock input is selected

Because the X1 pin is used as an external clock input pin, P23/ANI3 cannot be used as an I/O port pin or an analog input pin of A/D converter.

(3) High-speed internal oscillation clock is selected

P23/ANI3 and P22/ANI2 pins can be used as I/O port pins or analog input pins of A/D converter.

Remark × : don't care

Figure 5-2. Format of Option Byte (2/2)

LIOCP	Low-speed internal oscillates
1	Cannot be stopped (oscillation does not stop even if 1 is written to the LSRSTOP bit)
0	Can be stopped by software (oscillation stops when 1 is written to the LSRSTOP bit)

- Cautions**
1. If it is selected that low-speed internal oscillator cannot be stopped, the count clock to the watchdog timer (WDT) is fixed to low-speed internal oscillation clock.
 2. If it is selected that low-speed internal oscillator can be stopped by software, supply of the count clock to WDT is stopped in the HALT/STOP mode, regardless of the setting of bit 0 (LSRSTOP) of the low-speed internal oscillation mode register (LSRCM). Similarly, clock supply is also stopped when a clock other than the low-speed internal oscillation clock is selected as a count clock to WDT.
While the low-speed internal oscillator is operating (LSRSTOP = 0), the clock can be supplied to the 8-bit timer H1 even in the STOP mode.

- Remarks**
1. (): $f_x = 10 \text{ MHz}$
 2. For the oscillation stabilization time of the resonator, refer to the characteristics of the resonator to be used.
 3. An example of software coding for setting the option bytes is shown below.

```
OPB CSEG AT 0080H
DB 10010001B          ; Set to option byte
                      ; Low-speed internal oscillator cannot be stopped
                      ; The system clock is a crystal or ceramic resonator.
                      ; The RESET pin is used as an input-only port pin (P34).
                      ; Minimum oscillation stabilization time ( $2^{10}/f_x$ )
```
 4. For details on the timing at which the option byte is referenced, see the chapter of the reset function **78K0S/KY1+ User's Manual (U16994E)**

6. SOURCE CLOCK OF EACH TIMER

(1) Count clock selection by 16-bit timer/event counter 00 (TM00)

- f_{XP} (10 MHz)
- f_{XP}/22 (2.5 MHz)
- f_{XP}/28 (39.06 kHz)
- TI000 pin valid edge^{Note}

Note The external clock requires a pulse longer than two cycles of the internal count clock (f_{XP}).

- Remarks**
1. f_{XP}: Oscillation frequency of clock supplied to peripheral hardware
 2. (): f_{XP} = 10 MHz

(2) Count clock selection by 8-bit timer/event counter H1 (TMH1)

- f_{XP}(10 MHz)
- f_{XP}/22(2.5 MHz)
- f_{XP}/24(625 kHz)
- f_{XP}/26(156.25 kHz)
- f_{XP}/212(2.44 kHz)
- f_{R/L}/27(1.88 kHz (TYP.))

- Remarks**
1. f_{XP}: Oscillation frequency of clock to peripheral hardware
 2. f_{R/L}: Low-speed internal oscillation clock oscillation frequency
 3. Figures in parentheses apply to operation at f_{XP} = 10 MHz, f_{R/L} = 240 kHz (TYP.).

(3) Overflow time setting by watchdog timer

Overflow time setting	
During Low-Speed Internal oscillation Clock Operation	During System Clock Operation
2 ¹¹ /f _{R/L} (4.27 ms)	2 ¹³ /f _X (819.2 μs)
2 ¹² /f _{R/L} (8.53 ms)	2 ¹⁴ /f _X (1.64 ms)
2 ¹³ /f _{R/L} (17.07 ms)	2 ¹⁵ /f _X (3.28 ms)
2 ¹⁴ /f _{R/L} (34.13 ms)	2 ¹⁶ /f _X (6.55 ms)
2 ¹⁵ /f _{R/L} (68.27 ms)	2 ¹⁷ /f _X (13.11 ms)
2 ¹⁶ /f _{R/L} (136.53 ms)	2 ¹⁸ /f _X (26.21 ms)
2 ¹⁷ /f _{R/L} (273.07 ms)	2 ¹⁹ /f _X (52.43 ms)
2 ¹⁸ /f _{R/L} (546.13 ms)	2 ²⁰ /f _X (104.86 ms)

- Remarks**
1. f_{R/L}: Low-speed internal oscillation clock oscillation frequency
 2. f_X: System clock oscillation frequency
 3. Figures in parentheses apply to operation at f_{R/L} = 480 kHz (MAX.), f_X = 10 MHz.

7. ELECTRICAL SPECIFICATIONS (TARGET VALUES)

Caution These specifications show target values, which may change after device evaluation. The operating voltage range may also change.

Absolute Maximum Ratings (T_A = 25°C)

Parameter	Symbol	Conditions	Ratings	Unit
Supply voltage	V _{DD}		-0.3 to +6.5	V
	V _{SS}		-0.3 to +0.3	V
Input voltage	V _I	P20 to P23, P32, P34, P40 to P47	-0.3 to V _{DD} + 0.3 ^{Note}	V
Output voltage	V _O		-0.3 to V _{DD} + 0.3 ^{Note}	V
Analog input voltage	V _{AN}		-0.3 to V _{DD} + 0.3 ^{Note}	V
Output current, high	I _{OH}	Per pin	-10.0	mA
		Total of P20 to P23, P32, P40 to P47	-44.0	mA
Output current, low	I _{OL}	Per pin	20.0	mA
		Total of P20 to P23, P32, P40 to P47	44.0	mA
Operating ambient temperature	T _A	In normal operation mode	-40 to +85	°C
		During flash memory programming		°C
Storage temperature	T _{stg}	Flash memory blank status	-65 to +150	°C
		Flash memory programming already performed	-40 to +125	°C

Note Must be 6.5 V or lower

Caution Product quality may suffer if the absolute maximum rating is exceeded even momentarily for any parameter. That is, the absolute maximum ratings are rated values at which the product is on the verge of suffering physical damage, and therefore the product must be used under conditions that ensure that the absolute maximum ratings are not exceeded.

Remark Unless specified otherwise, the characteristics of alternate-function pins are the same as those of port pins.

X1 Oscillator Characteristics (T_A = -40 to +85°C, V_{DD} = 2.0 to 5.5 V^{Note 1}, V_{SS} = 0 V)

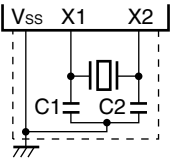
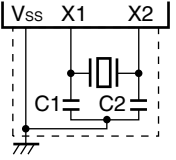
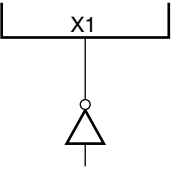
Resonator	Recommended Circuit	Parameter	Conditions	MIN.	TYP.	MAX.	Unit
Ceramic resonator		Oscillation frequency (f _x) ^{Note 2}		1		10.0	MHz
Crystal resonator		Oscillation frequency (f _x) ^{Note 2}		1		10.0	MHz
External clock		X1 input frequency (f _x) ^{Note 2}	2.7 V ≤ V _{DD} ≤ 5.5 V	1		10.0	MHz
			2.0 V ≤ V _{DD} < 2.7 V	1		5.0	
		X1 input high-/low-level width (t _{xH} , t _{xL})	2.7 V ≤ V _{DD} ≤ 5.5 V	0.045		0.5	μs
			2.0 V ≤ V _{DD} < 2.7 V	0.09		0.5	

- Notes**
1. Use this product in a voltage range of 2.2 to 5.5 V because the detection voltage (V_{POC}) of the power-on clear (POC) circuit is 2.1 V ±0.1 V.
 2. Indicates only oscillator characteristics. Refer to **AC Characteristics** for instruction execution time.

Caution When using the X1 oscillator, wire as follows in the area enclosed by the broken lines in the above figures to avoid an adverse effect from wiring capacitance.

- Keep the wiring length as short as possible.
- Do not cross the wiring with the other signal lines.
- Do not route the wiring near a signal line through which a high fluctuating current flows.
- Always make the ground point of the oscillator capacitor the same potential as V_{SS}.
- Do not ground the capacitor to a ground pattern through which a high current flows.
- Do not fetch signals from the oscillator.

Remark For the resonator selection and oscillator constant, users are required to either evaluate the oscillation themselves or apply to the resonator manufacturer for evaluation.

High-Speed Internal Oscillator Characteristics (T_A = -40 to +85°C, V_{DD} = 2.0 to 5.5 V^{Note 1}, V_{SS} = 0 V)

Resonator	Parameter	Conditions	MIN.	TYP.	MAX.	Unit	
High-speed internal oscillator	Oscillation frequency (f _x = 8 MHz ^{Note 2}) deviation	2.7 V ≤ V _{DD} ≤ 5.5 V	T _A = -10 to +70°C			±3	%
			T _A = -40 to +85°C			±5	%
	Oscillation frequency (f _x) ^{Note 2}	2.0 V ≤ V _{DD} < 2.7 V	5.5			MHz	

- Notes**
1. Use this product in a voltage range of 2.2 to 5.5 V because the detection voltage (V_{POC}) of the power-on-clear (POC) circuit is 2.1 V ±0.1 V.
 2. Indicates only oscillator characteristics. Refer to **AC Characteristics** for instruction execution time.

Low-Speed Internal Oscillator Characteristics (T_A = -40 to +85°C, V_{DD} = 2.0 to 5.5 V^{Note}, V_{SS} = 0 V)

Resonator	Parameter	Conditions	MIN.	TYP.	MAX.	Unit
Low-speed internal oscillator	Oscillation frequency (f _{RL})		120	240	480	kHz

Note Use this product in a voltage range of 2.2 to 5.5 V because the detection voltage (V_{POC}) of the power-on clear (POC) circuit is 2.1 V ±0.1 V.

DC Characteristics (T_A = -40 to +85°C, V_{DD} = 2.0 to 5.5 V^{Note}, V_{SS} = 0 V) (1/2)

Parameter	Symbol	Conditions		MIN.	TYP.	MAX.	Unit
Output current, high	I _{OH}	Per pin	2.0 V ≤ V _{DD} ≤ 5.5 V			-5	mA
		Total of all pins	4.0 V ≤ V _{DD} ≤ 5.5 V			-25	mA
			2.0 V ≤ V _{DD} < 4.0 V			-15	mA
Output current, low	I _{OL}	Per pin	2.0 V ≤ V _{DD} ≤ 5.5 V			10	mA
		Total of all pins	4.0 V ≤ V _{DD} ≤ 5.5 V			30	mA
			2.0 V ≤ V _{DD} < 4.0 V			15	mA
Input voltage, high	V _{IH1}	P23 in external clock mode and pins other than P20 and P21		0.8V _{DD}		V _{DD}	V
	V _{IH2}	P23 in other than external clock mode, P20 and P21		0.7V _{DD}		V _{DD}	V
Input voltage, low	V _{IL1}	P23 in external clock mode and pins other than P20 and P21		0		0.2V _{DD}	V
	V _{IL2}	P23 in other than external clock mode, P20 and P21		0		0.3V _{DD}	V
Output voltage, high	V _{OH}	Total of output pins I _{OH} = -15 mA	4.0 V ≤ V _{DD} ≤ 5.5 V I _{OH} = -5 mA	V _{DD} - 1.0			V
		I _{OH} = -100 μA	2.0 V ≤ V _{DD} < 4.0 V	V _{DD} - 0.5			V
Output voltage, low	V _{OL}	Total of output pins I _{OL} = 30 mA	4.0 V ≤ V _{DD} ≤ 5.5 V I _{OL} = 10 mA			1.3	V
		2.0 V ≤ V _{DD} < 4.0 V I _{OL} = 400 μA				0.4	V
Input leakage current, high	I _{LIH}	V _I = V _{DD}	Pins other than X1			3	μA
Input leakage current, low	I _{LIL}	V _I = 0 V	Pins other than X1			-3	μA
Output leakage current, high	I _{LOH}	V _O = V _{DD}	Pins other than X2			3	μA
Output leakage current, low	I _{LOL}	V _O = 0 V	Pins other than X2			-3	μA
Pull-up resistance value	R _{PU}	V _I = 0 V		10	30	100	kΩ
Pull-down resistance value	R _{PD}	P22, P23, reset status		10	30	100	kΩ

Note Use this product in a voltage range of 2.2 to 5.5 V because the detection voltage (V_{POC}) of the power-on clear (POC) circuit is 2.1 V ±0.1 V.

Remark Unless specified otherwise, the characteristics of alternate-function pins are the same as those of port pins.

DC Characteristics (T_A = -40 to +85°C, V_{DD} = 2.0 to 5.5 V^{Note 1}, V_{SS} = 0 V) (2/2)

Parameter	Symbol	Conditions		MIN.	TYP.	MAX.	Unit	
Supply current ^{Note 2}	I _{DD1} ^{Note 3}	Crystal/ceramic oscillation, external clock input oscillation operating mode ^{Note 6}	f _X = 10 MHz V _{DD} = 5.0 V ±10% ^{Note 4}	When A/D converter is stopped		6.1	12.2	mA
				When A/D converter is operating		7.6	15.2	
			f _X = 6 MHz V _{DD} = 5.0 V ±10% ^{Note 4}	When A/D converter is stopped		5.5	11.0	mA
				When A/D converter is operating			14.0	
			f _X = 5 MHz V _{DD} = 3.0 V ±10% ^{Note 5}	When A/D converter is stopped		3.0	6.0	mA
				When A/D converter is operating		4.5	9.0	
	I _{DD2}	Crystal/ceramic oscillation, external clock input HALT mode ^{Note 6}	f _X = 10 MHz V _{DD} = 5.0 V ±10% ^{Note 4}	When peripheral functions are stopped		1.7	3.8	mA
				When peripheral functions are operating			6.7	
			f _X = 6 MHz V _{DD} = 5.0 V ±10% ^{Note 4}	When peripheral functions are stopped		1.3	3.0	mA
				When peripheral functions are operating			6.0	
			f _X = 5 MHz V _{DD} = 3.0 V ±10% ^{Note 5}	When peripheral functions are stopped		0.48	1	mA
				When peripheral functions are operating			2.1	
	I _{DD3} ^{Note 3}	High-speed internal oscillation operating mode ^{Note 7}	f _X = 8 MHz V _{DD} = 5.0 V ±10% ^{Note 4}	When A/D converter is stopped		5.0	10.0	mA
				When A/D converter is operating		6.5	13.0	
I _{DD4}	High-speed internal oscillation HALT mode ^{Note 7}	f _X = 8 MHz V _{DD} = 5.0 V ±10% ^{Note 4}	When peripheral functions are stopped		1.4	3.2	mA	
			When peripheral functions are operating			5.9		
I _{DD5}	STOP mode	V _{DD} = 5.0 V ±10%	When low-speed internal oscillation is stopped		3.5	35.5	μA	
			When low-speed internal oscillation is operating		17.5	63.5		
		V _{DD} = 3.0 V ±10%	When low-speed internal oscillation is stopped		3.5	15.5	μA	
			When low-speed internal oscillation is operating		11.0	30.5		

- Notes**
1. Use this product in a voltage range of 2.2 to 5.5 V because the detection voltage (V_{POC}) of the power-on clear (POC) circuit is 2.1 V ±0.1 V.
 2. Total current flowing through the internal power supply (V_{DD}). However, the current that flows through the pull-up resistors of ports is not included.
 3. I_{DD1} and I_{DD3} include peripheral operation current.
 4. When the processor clock control register (PCC) is set to 00H.
 5. When the processor clock control register (PCC) is set to 02H.
 6. When crystal/ceramic oscillation clock, external clock input is selected as the system clock source using the option byte.
 7. When high-speed internal oscillation clock is selected as the system clock source using the option byte.

AC Characteristics

Basic operation (T_A = -40 to +85°C, V_{DD} = 2.0 to 5.5 V^{Note 1}, V_{SS} = 0 V)

Parameter	Symbol	Conditions	MIN.	TYP.	MAX.	Unit	
Cycle time (minimum instruction execution time)	T _{CY}	Crystal/ceramic oscillation clock, external clock input	4.0 V ≤ V _{DD} ≤ 5.5 V	0.2		16	μs
			3.0 V ≤ V _{DD} < 4.0 V	0.33		16	μs
			2.7 V ≤ V _{DD} < 3.0 V	0.4		16	μs
			2.0 V ≤ V _{DD} < 2.7 V	1		16	μs
		High-speed internal oscillation clock	4.0 V ≤ V _{DD} ≤ 5.5 V	0.23		4.22	μs
			2.7 V ≤ V _{DD} < 4.0 V	0.47		4.22	μs
2.0 V ≤ V _{DD} < 2.7 V	0.95			4.22	μs		
TI000/TI010 input high-level width, low-level width	t _{TIH} , t _{TIL}	4.0 V ≤ V _{DD} ≤ 5.5 V	2/fsam+ 0.1 ^{Note 2}			μs	
		2.0 V ≤ V _{DD} < 4.0 V	2/fsam+ 0.2 ^{Note 2}			μs	
Interrupt input high-level width, low-level width	t _{INTH} , t _{INTL}		1			μs	
RESET input low-level width	t _{RSL}		2			μs	

Notes 1. Use this product in a voltage range of 2.2 to 5.5 V because the detection voltage (V_{POC}) of the power-on clear (POC) circuit is 2.1 V ±0.1 V.

2. Selection of fsam = f_{XP}, f_{XP}/4, or f_{XP}/256 is possible using bits 0 and 1 (PRM000, PRM001) of prescaler mode register 00 (PRM00). Note that when selecting the TI000/TI010 valid edge as the count clock, fsam = f_{XP}.

T_{CY} vs. V_{DD} (Crystal/Ceramic Oscillation Clock, External Clock Input)

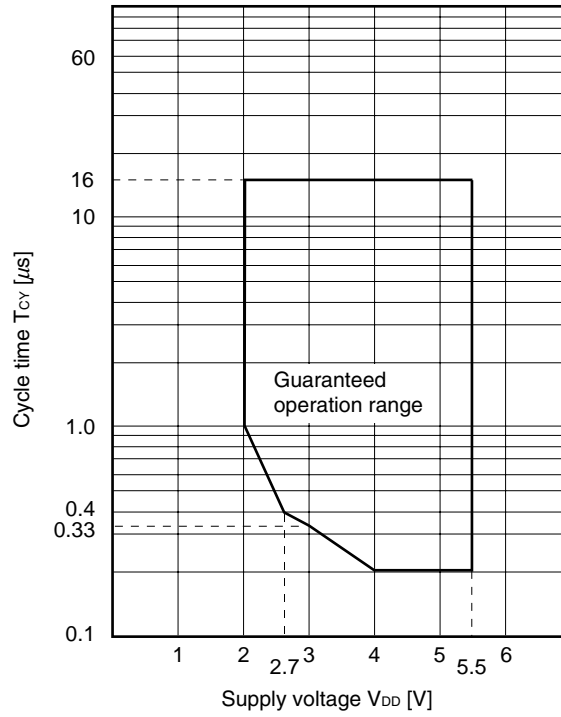

T_{CY} vs. V_{DD} (High-speed internal oscillator Clock)

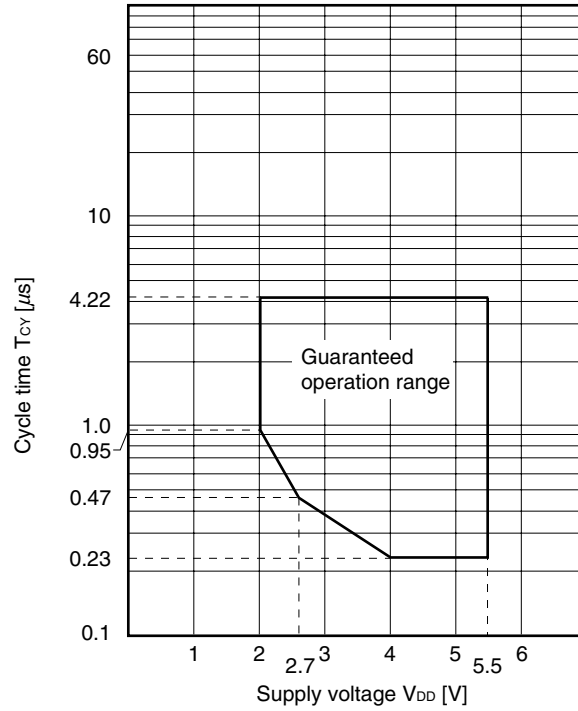

AC Timing Test Points (Excluding X1 Input)

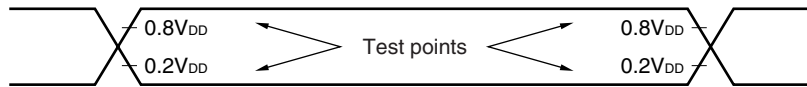

Clock Timing

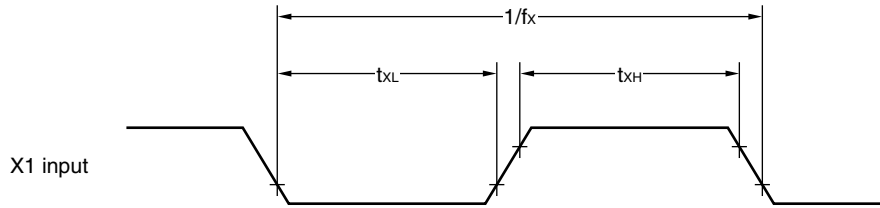

T1000 Timing

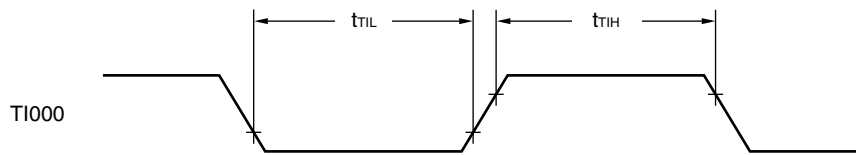

Interrupt Input Timing

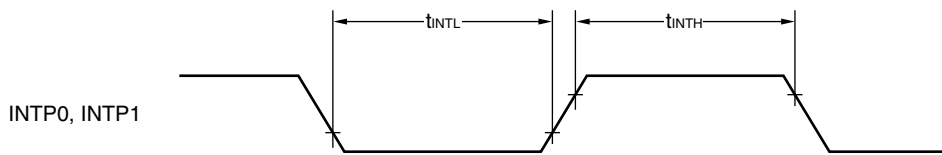

RESET Input Timing

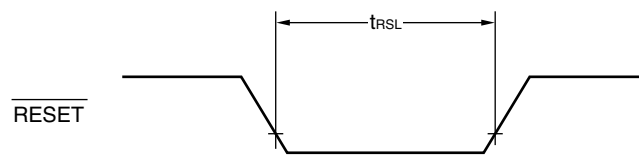

A/D Converter Characteristics (T_A = -40 to +85°C, 2.7 V ≤ V_{DD} ≤ 5.5 V^{Note 1}, V_{SS} = 0 V^{Note 2})

(1) A/D converter basic characteristics

Parameter	Symbol	Conditions	MIN.	TYP.	MAX.	Unit
Resolution			10	10	10	bit
Conversion time	t _{CONV}	4.5 V ≤ V _{DD} ≤ 5.5 V	3.0		100	μs
		4.0 V ≤ V _{DD} < 4.5 V	4.8		100	μs
		2.85 V ≤ V _{DD} < 4.0 V	6.0		100	μs
		2.7 V ≤ V _{DD} < 2.85 V	14.0		100	μs
Analog input voltage	V _{AIN}		V _{SS} ^{Note 2}		V _{DD}	V

(2) A/D Converter Characteristics (high-speed internal oscillation clock)

Parameter	Symbol	Conditions	MIN.	TYP.	MAX.	Unit
Overall error ^{Notes 3, 4}	AINL			-0.1 to +0.2 ^{Note 5}	-0.35 to +0.45	%FSR
Zero-scale error ^{Notes 3, 4}	Ezs			-0.1 to +0.2 ^{Note 5}	-0.35 to +0.45	%FSR
Full-scale error ^{Notes 3, 4}	Efs			-0.1 to +0.2 ^{Note 5}	-0.35 to +0.40	%FSR
Integral non-linearity error ^{Note 3}	ILE			±1 ^{Note 5}	±3	LSB
Differential non-linearity error ^{Note 3}	DLE			±1 ^{Note 5}	±1.5	LSB

(3) A/D Converter Characteristics (Crystal/Ceramic Oscillation Clock, External Clock)

Parameter	Symbol	Conditions	MIN.	TYP.	MAX.	Unit
Overall error ^{Notes 1, 2}	AINL	4.0 V ≤ V _{DD} ≤ 5.5 V		-0.20 to +0.35 ^{Note 5}	-0.35 to +0.65	%FSR
		2.7 V ≤ V _{DD} < 4.0 V		±0.25 ^{Note 5}	-0.35 to +0.55	%FSR
Zero-scale error ^{Notes 3, 4}	Ezs	4.0 V ≤ V _{DD} ≤ 5.5 V		-0.20 to +0.35 ^{Note 5}	-0.35 to +0.65	%FSR
		2.7 V ≤ V _{DD} < 4.0 V		±0.25 ^{Note 5}	-0.35 to +0.55	%FSR
Full-scale error ^{Notes 3, 4}	Efs	4.0 V ≤ V _{DD} ≤ 5.5 V		-0.20 to +0.35 ^{Note 5}	-0.35 to +0.55	%FSR
		2.7 V ≤ V _{DD} < 4.0 V		±0.25 ^{Note 5}	-0.35 to +0.50	%FSR
Integral non-linearity error ^{Note 3}	ILE	4.0 V ≤ V _{DD} ≤ 5.5 V		±1.5 ^{Note 5}	±3.0	LSB
		2.7 V ≤ V _{DD} < 4.0 V		±1.5 ^{Note 5}	±4.0	LSB
Differential non-linearity error ^{Note 3}	DLE	4.0 V ≤ V _{DD} ≤ 5.5 V		±1.0 ^{Note 5}	±2.5	LSB
		2.7 V ≤ V _{DD} < 4.0 V		±1.0 ^{Note 5}	±2.5	LSB

- Notes**
1. In the μPD78F9210FH, 78F9211FH, 78F9212FH, V_{DD} functions alternately as the A/D converter reference voltage input. When using the A/D converter, stabilize V_{DD} at the supply voltage used (2.7 to 5.5 V).
 2. In the μPD78F9210FH, 78F9211FH, 78F9212FH, V_{SS} functions alternately as the ground potential of the A/D converter. Be sure to connect V_{SS} to a stabilized GND (= 0 V).
 3. Excludes quantization error (±1/2 LSB).
 4. This value is indicated as a ratio (%FSR) to the full-scale value.
 5. A value when HALT mode is set by an instruction immediately after A/D conversion starts.

Caution The conversion accuracy may be degraded if the level of a port that is not used for A/D conversion is changed during A/D conversion.

POC Circuit Characteristics (T_A = -40 to +85°C)

Parameter	Symbol	Conditions	MIN.	TYP.	MAX.	Unit
Detection voltage	V _{POC}		2.0	2.1	2.2	V
Power supply rise time	t _{PTH}	V _{DD} : 0 V → 2.1 V	1.5			μs
Response delay time 1 ^{Note 1}	t _{PTHD}	When power supply rises, after reaching detection voltage (MAX.)			3.0	ms
Response delay time 2 ^{Note 2}	t _{PD}	When power supply falls			1.0	ms
Minimum pulse width	t _{PW}		0.2			ms

- Notes 1.** Time required from voltage detection to internal reset release.
2. Time required from voltage detection to internal reset signal generation.

POC Circuit Timing

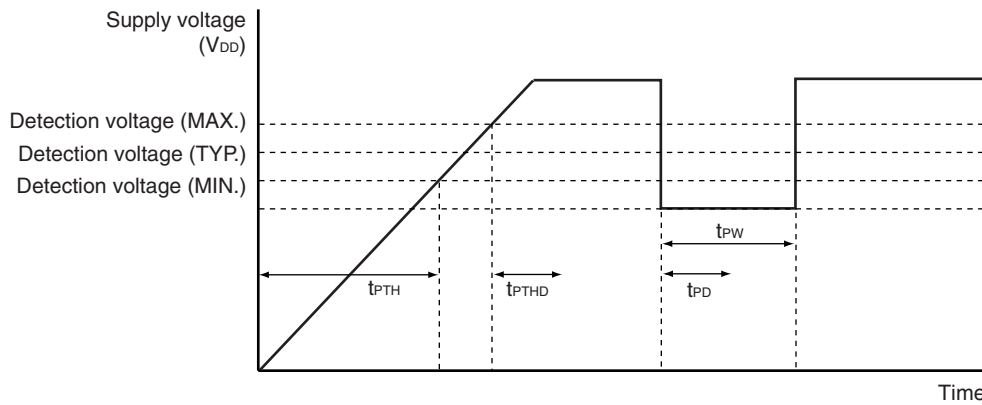

LVI Circuit Characteristics (T_A = -40 to +85°C)

Parameter	Symbol	Conditions	MIN.	TYP.	MAX.	Unit
Detection voltage	V _{LV10}		4.1	4.3	4.5	V
	V _{LV11}		3.9	4.1	4.3	V
	V _{LV12}		3.7	3.9	4.1	V
	V _{LV13}		3.5	3.7	3.9	V
	V _{LV14}		3.3	3.5	3.7	V
	V _{LV15}		3.15	3.3	3.45	V
	V _{LV16}		2.95	3.1	3.25	V
	V _{LV17}		2.7	2.85	3.0	V
	V _{LV18}		2.5	2.6	2.7	V
	V _{LV19}		2.25	2.35	2.45	V
Response time ^{Note 1}	t _{LD}			0.2	2.0	ms
Minimum pulse width	t _{LW}		0.2			ms
Operation stabilization wait time ^{Note 2}	t _{LWAIT}			0.1	0.2	ms

- Notes**
1. Time required from voltage detection to interrupt output or internal reset signal generation.
 2. Time required from setting LVION to 1 to operation stabilization.

- Remarks**
1. V_{LV10} > V_{LV11} > V_{LV12} > V_{LV13} > V_{LV14} > V_{LV15} > V_{LV16} > V_{LV17} > V_{LV18} > V_{LV19}
 2. V_{POC} < V_{LV1m} (m = 0 to 9)

LVI Circuit Timing

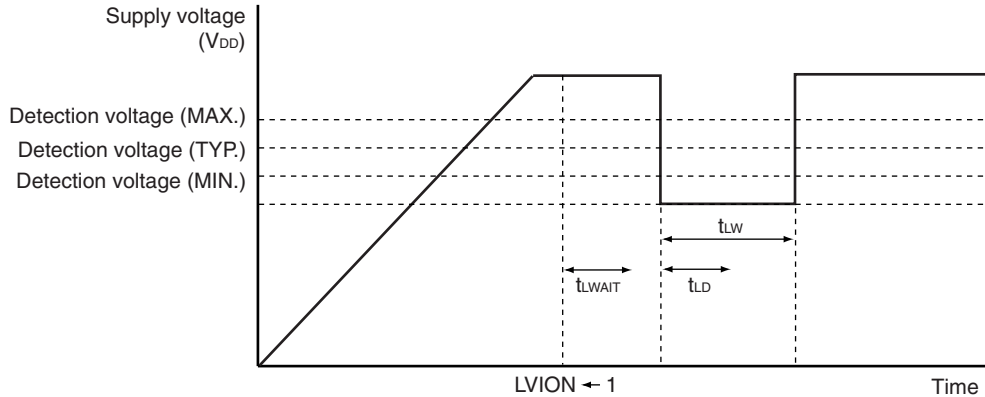

Data Memory STOP Mode Low Supply Voltage Data Retention Characteristics (T_A = -40 to +85°C)

Parameter	Symbol	Conditions	MIN.	TYP.	MAX.	Unit
Data retention supply voltage	V _{DDDR}		2.0		5.5	V
Release signal set time	t _{SREL}		0			μs

Flash Memory Programming Characteristics (T_A = -40 to +85°C, 2.7 V ≤ V_{DD} ≤ 5.5 V, V_{SS} = 0 V)

Parameter	Symbol	Conditions	MIN.	TYP.	MAX.	Unit
Supply current	I _{DD}	V _{DD} = 5.5 V			7.0	mA
Erase count ^{Note} (per 1 block)	N _{ERASE}	T _A = -40 to +85°C	1000			Times
Chip erase time	T _{CERASE}	T _A = -10 to +85°C, N _{ERASE} ≤ 100	4.5 V ≤ V _{DD} ≤ 5.5 V		0.8	s
			3.5 V ≤ V _{DD} < 4.5 V		1.0	s
			2.7 V ≤ V _{DD} < 3.5 V		1.2	s
		T _A = -10 to +85°C, N _{ERASE} ≤ 1000	4.5 V ≤ V _{DD} ≤ 5.5 V		4.8	s
			3.5 V ≤ V _{DD} < 4.5 V		5.2	s
			2.7 V ≤ V _{DD} < 3.5 V		6.1	s
		T _A = -40 to +85°C, N _{ERASE} ≤ 100	4.5 V ≤ V _{DD} ≤ 5.5 V		1.6	s
			3.5 V ≤ V _{DD} < 4.5 V		1.8	s
			2.7 V ≤ V _{DD} < 3.5 V		2.0	s
		T _A = -40 to +85°C, N _{ERASE} ≤ 1000	4.5 V ≤ V _{DD} ≤ 5.5 V		9.1	s
			3.5 V ≤ V _{DD} < 4.5 V		10.1	s
			2.7 V ≤ V _{DD} < 3.5 V		12.3	s
Block erase time	T _{BERASE}	T _A = -10 to +85°C, N _{ERASE} ≤ 100	4.5 V ≤ V _{DD} ≤ 5.5 V		0.4	s
			3.5 V ≤ V _{DD} < 4.5 V		0.5	s
			2.7 V ≤ V _{DD} < 3.5 V		0.6	s
		T _A = -10 to +85°C, N _{ERASE} ≤ 1000	4.5 V ≤ V _{DD} ≤ 5.5 V		2.6	s
			3.5 V ≤ V _{DD} < 4.5 V		2.8	s
			2.7 V ≤ V _{DD} < 3.5 V		3.3	s
		T _A = -40 to +85°C, N _{ERASE} ≤ 100	4.5 V ≤ V _{DD} ≤ 5.5 V		0.9	s
			3.5 V ≤ V _{DD} < 4.5 V		1.0	s
			2.7 V ≤ V _{DD} < 3.5 V		1.1	s
		T _A = -40 to +85°C, N _{ERASE} ≤ 1000	4.5 V ≤ V _{DD} ≤ 5.5 V		4.9	s
			3.5 V ≤ V _{DD} < 4.5 V		5.4	s
			2.7 V ≤ V _{DD} < 3.5 V		6.6	s
Byte write time	T _{WRITE}	T _A = -40 to +85°C, N _{ERASE} ≤ 1000			150	μs
Internal verify	T _{VERIFY}	Per 1 block			6.8	ms
		Per 1 byte			27	μs
Blank check	T _{BLKCHK}	Per 1 block			480	μs
Retention years		T _A = 85°C ^{Note 2} , N _{ERASE} ≤ 1000	10			Years

Notes 1. Depending on the erasure count (N_{ERASE}), the erase time varies. Refer to the chip erase time and block erase time parameters.

2. When the average temperature when operating and not operating is 85°C.

Remark When a product is first written after shipment, “erase → write” and “write only” are both taken as one rewrite.

8. PACKAGE DRAWING (PRELIMINARY)

16-PIN FBGA (WAFER LEVEL CSP) (1.93x2.24)

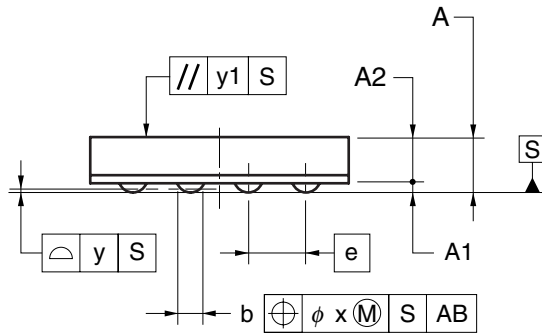
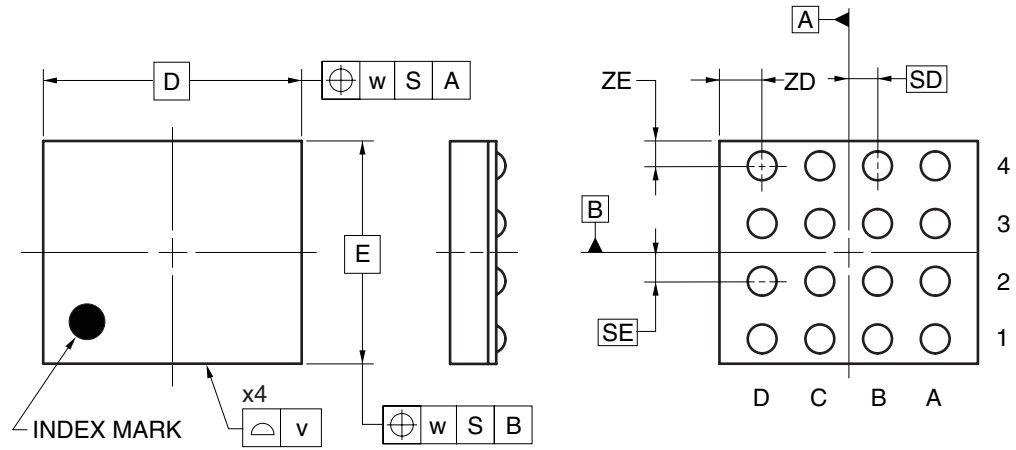

(UNIT:mm)

ITEM	DIMENSIONS
D	2.24
E	1.93
v	0.15
w	0.20
A	0.48±0.04
A1	0.08±0.02
A2	0.40
e	0.50
SD	0.25
SE	0.25
b	0.25±0.05
x	0.05
y	0.08
y1	0.20
ZD	0.37
ZE	0.215

P16FH-50-2A2

© NEC Electronics Corporation 2005

APPENDIX A. RELATED DOCUMENTS

The related document indicated in this publication may include preliminary versions. However, preliminary versions are not marked as such.

Documents Related to Devices

Document Name	Document No.
μPD78F9210FH, 78F9211FH, 78F9212FH Preliminary Product Information	This manual
78K0S/KY1+ User's Manual	U16994E
78K/0S Series Instructions User's Manual	U12326E

Documents Related to Development Tools (Software) (User's Manuals)

Document Name	Document No.	
RA78K0S Ver. 1.50 Assembler Package	Operation	U17391E
	Language	U17390E
	Structured Assembly Language	U17389E
CC78K0S Ver. 1.60 C Compiler	Operation	U17416E
	Language	U17415E
SM+ System Simulator	Operation	U17246E
	External Part User Open Interface Specifications	U17247E
ID78K0S-QB Ver. 2.81 Integrated Debugger	Operation	U17287E
PM+ Ver. 5.20		U16934E

Documents Related to Development Tools (Hardware) (User's Manuals)

Document Name	Document No.
IE-78K0S-NS In-Circuit Emulator	U13549E
IE-78K0S-NS-A In-Circuit Emulator	U15207E
QB-78K0SKX1H In-Circuit Emulator	U17272E

Documents Related to Flash Memory Programming

Document Name	Document No.
PG-FP4 Flash Memory Programmer User's Manual	U15260E
PG-FPL2 Flash Memory Programmer User's Manual	U17307E

Caution The related documents listed above are subject to change without notice. Be sure to use the latest version of each document when designing.

Other Documents

Document Name	Document No.
SEMICONDUCTOR SELECTION GUIDE – Products and Packages –	X13769X
Semiconductor Device Mount Manual	Note
Quality Grades on NEC Semiconductor Devices	C11531E
NEC Semiconductor Device Reliability/Quality Control System	C10983E
Guide to Prevent Damage for Semiconductor Devices by Electrostatic Discharge (ESD)	C11892E

Note See the “Semiconductor Device Mount Manual” website (<http://www.necel.com/pkg/en/mount/index.html>).

Caution The related documents listed above are subject to change without notice. Be sure to use the latest version of each document when designing.

NOTES FOR CMOS DEVICES

① VOLTAGE APPLICATION WAVEFORM AT INPUT PIN

Waveform distortion due to input noise or a reflected wave may cause malfunction. If the input of the CMOS device stays in the area between V_{IL} (MAX) and V_{IH} (MIN) due to noise, etc., the device may malfunction. Take care to prevent chattering noise from entering the device when the input level is fixed, and also in the transition period when the input level passes through the area between V_{IL} (MAX) and V_{IH} (MIN).

② HANDLING OF UNUSED INPUT PINS

Unconnected CMOS device inputs can be cause of malfunction. If an input pin is unconnected, it is possible that an internal input level may be generated due to noise, etc., causing malfunction. CMOS devices behave differently than Bipolar or NMOS devices. Input levels of CMOS devices must be fixed high or low by using pull-up or pull-down circuitry. Each unused pin should be connected to V_{DD} or GND via a resistor if there is a possibility that it will be an output pin. All handling related to unused pins must be judged separately for each device and according to related specifications governing the device.

③ PRECAUTION AGAINST ESD

A strong electric field, when exposed to a MOS device, can cause destruction of the gate oxide and ultimately degrade the device operation. Steps must be taken to stop generation of static electricity as much as possible, and quickly dissipate it when it has occurred. Environmental control must be adequate. When it is dry, a humidifier should be used. It is recommended to avoid using insulators that easily build up static electricity. Semiconductor devices must be stored and transported in an anti-static container, static shielding bag or conductive material. All test and measurement tools including work benches and floors should be grounded. The operator should be grounded using a wrist strap. Semiconductor devices must not be touched with bare hands. Similar precautions need to be taken for PW boards with mounted semiconductor devices.

④ STATUS BEFORE INITIALIZATION

Power-on does not necessarily define the initial status of a MOS device. Immediately after the power source is turned ON, devices with reset functions have not yet been initialized. Hence, power-on does not guarantee output pin levels, I/O settings or contents of registers. A device is not initialized until the reset signal is received. A reset operation must be executed immediately after power-on for devices with reset functions.

⑤ POWER ON/OFF SEQUENCE

In the case of a device that uses different power supplies for the internal operation and external interface, as a rule, switch on the external power supply after switching on the internal power supply. When switching the power supply off, as a rule, switch off the external power supply and then the internal power supply. Use of the reverse power on/off sequences may result in the application of an overvoltage to the internal elements of the device, causing malfunction and degradation of internal elements due to the passage of an abnormal current.

The correct power on/off sequence must be judged separately for each device and according to related specifications governing the device.

⑥ INPUT OF SIGNAL DURING POWER OFF STATE

Do not input signals or an I/O pull-up power supply while the device is not powered. The current injection that results from input of such a signal or I/O pull-up power supply may cause malfunction and the abnormal current that passes in the device at this time may cause degradation of internal elements. Input of signals during the power off state must be judged separately for each device and according to related specifications governing the device.

SuperFlash is a registered trademark of Silicon Storage Technology, Inc. in several countries including the United States and Japan.

Caution: This product uses SuperFlash® technology licensed from Silicon Storage Technology, Inc.

- **The information contained in this document is being issued in advance of the production cycle for the product. The parameters for the product may change before final production or NEC Electronics Corporation, at its own discretion, may withdraw the product prior to its production.**
- **Not all products and/or types are available in every country. Please check with an NEC Electronics sales representative for availability and additional information.**
- No part of this document may be copied or reproduced in any form or by any means without the prior written consent of NEC Electronics. NEC Electronics assumes no responsibility for any errors that may appear in this document.
- NEC Electronics does not assume any liability for infringement of patents, copyrights or other intellectual property rights of third parties by or arising from the use of NEC Electronics products listed in this document or any other liability arising from the use of such products. No license, express, implied or otherwise, is granted under any patents, copyrights or other intellectual property rights of NEC Electronics or others.
- Descriptions of circuits, software and other related information in this document are provided for illustrative purposes in semiconductor product operation and application examples. The incorporation of these circuits, software and information in the design of a customer's equipment shall be done under the full responsibility of the customer. NEC Electronics assumes no responsibility for any losses incurred by customers or third parties arising from the use of these circuits, software and information.
- While NEC Electronics endeavors to enhance the quality, reliability and safety of NEC Electronics products, customers agree and acknowledge that the possibility of defects thereof cannot be eliminated entirely. To minimize risks of damage to property or injury (including death) to persons arising from defects in NEC Electronics products, customers must incorporate sufficient safety measures in their design, such as redundancy, fire-containment and anti-failure features.
- NEC Electronics products are classified into the following three quality grades: "Standard", "Special" and "Specific". The "Specific" quality grade applies only to NEC Electronics products developed based on a customer-designated "quality assurance program" for a specific application. The recommended applications of an NEC Electronics products depend on its quality grade, as indicated below. Customers must check the quality grade of each NEC Electronics product before using it in a particular application.
 - "Standard": Computers, office equipment, communications equipment, test and measurement equipment, audio and visual equipment, home electronic appliances, machine tools, personal electronic equipment and industrial robots.
 - "Special": Transportation equipment (automobiles, trains, ships, etc.), traffic control systems, anti-disaster systems, anti-crime systems, safety equipment and medical equipment (not specifically designed for life support).
 - "Specific": Aircraft, aerospace equipment, submersible repeaters, nuclear reactor control systems, life support systems and medical equipment for life support, etc.

The quality grade of NEC Electronics products is "Standard" unless otherwise expressly specified in NEC Electronics data sheets or data books, etc. If customers wish to use NEC Electronics products in applications not intended by NEC Electronics, they must contact an NEC Electronics sales representative in advance to determine NEC Electronics' willingness to support a given application.

(Note)

- (1) "NEC Electronics" as used in this statement means NEC Electronics Corporation and also includes its majority-owned subsidiaries.
- (2) "NEC Electronics products" means any product developed or manufactured by or for NEC Electronics (as defined above).

*For further information,
please contact:*

NEC Electronics Corporation
1753, Shimonumabe, Nakahara-ku,
Kawasaki, Kanagawa 211-8668,
Japan
Tel: 044-435-5111
<http://www.necel.com/>

[America]

NEC Electronics America, Inc.
2880 Scott Blvd.
Santa Clara, CA 95050-2554, U.S.A.
Tel: 408-588-6000
800-366-9782
<http://www.am.necel.com/>

[Europe]

NEC Electronics (Europe) GmbH
Arcadiastrasse 10
40472 Düsseldorf, Germany
Tel: 0211-65030
<http://www.eu.necel.com/>

Hanover Office
Podbielskistrasse 164
30177 Hannover
Tel: 0 511 33 40 2-0

Munich Office
Werner-Eckert-Strasse 9
81829 München
Tel: 0 89 92 10 03-0

Stuttgart Office
Industriestrasse 3
70565 Stuttgart
Tel: 0 711 99 01 0-0

United Kingdom Branch
Cygnus House, Sunrise Parkway
Linford Wood, Milton Keynes
MK14 6NP, U.K.
Tel: 01908-691-133

Succursale Française
9, rue Paul Dautier, B.P. 52180
78142 Velizy-Villacoublay Cédex
France
Tel: 01-3067-5800

Sucursal en España
Juan Esplandiú, 15
28007 Madrid, Spain
Tel: 091-504-2787

Tyskland Filial
Täby Centrum
Entrance S (7th floor)
18322 Täby, Sweden
Tel: 08 638 72 00

Filiale Italiana
Via Fabio Filzi, 25/A
20124 Milano, Italy
Tel: 02-667541

Branch The Netherlands
Limburglaan 5
5616 HR Eindhoven
The Netherlands
Tel: 040 265 40 10

[Asia & Oceania]

NEC Electronics (China) Co., Ltd
7th Floor, Quantum Plaza, No. 27 ZhiChunLu Haidian
District, Beijing 100083, P.R.China
TEL: 010-8235-1155
<http://www.cn.necel.com/>

NEC Electronics Shanghai Ltd.
Room 2509-2510, Bank of China Tower,
200 Yincheng Road Central,
Pudong New Area, Shanghai P.R. China P.C:200120
Tel: 021-5888-5400
<http://www.cn.necel.com/>

NEC Electronics Hong Kong Ltd.
12/F., Cityplaza 4,
12 Taikoo Wan Road, Hong Kong
Tel: 2886-9318
<http://www.hk.necel.com/>

Seoul Branch
11F., Samik Lavied'or Bldg., 720-2,
Yeoksam-Dong, Kangnam-Ku,
Seoul, 135-080, Korea
Tel: 02-558-3737

NEC Electronics Taiwan Ltd.
7F, No. 363 Fu Shing North Road
Taipei, Taiwan, R. O. C.
Tel: 02-2719-2377

NEC Electronics Singapore Pte. Ltd.
238A Thomson Road,
#12-08 Novena Square,
Singapore 307684
Tel: 6253-8311
<http://www.sg.necel.com/>

Mouser Electronics

Authorized Distributor

Click to View Pricing, Inventory, Delivery & Lifecycle Information:

Renesas Electronics:

[UPD78F9200MA-CAC-A](#) [UPD78F9222MC-5A4-A](#) [UPD78F9502MA-CAC-A](#) [uPD78F9202MA-CAC-A](#)
[UPD78F9221MC-5A4-A](#) [UPD78F9211MA-FAA-AX](#) [uPD78F9201MA-CAC-A](#) [UPD78F9232MC-5A4-A](#)
[UPD78F9234MC-5A4-A](#) [UPD78F9210MA-FAA-AX](#) [UPD78F9500MA-CAC-A](#) [UPD78F9212MA-FAA-AX](#)